

2011 PROGRAM

SOUTHERN REGION CONFERENCE OF THE AMERICAN ASSOCIATION FOR AGRICULTURAL EDUCATION

**HELD IN CONJUNCTION WITH THE MEETING OF
THE SOUTHERN ASSOCIATION OF AGRICULTURAL SCIENTISTS**

Hosted by:

University of Arkansas, Department of Agricultural and Extension Education

**February 5 - 8, 2011 – Corpus Christi, Texas
Omni Hotel Bayfront Tower/AmericanBank Center**

Southern Association of Agricultural Scientists (SAAS) Agricultural Education Division Officers

President and Conference Co-Chair: Don W. Edgar, University of Arkansas

Co-Chairs: Leslie D. Edgar & Donald M. Johnson, University of Arkansas

Vice-President: Rick Rudd, Virginia Tech

Past President: Craig Edwards, Oklahoma State University

American Association for Agricultural Education (AAAE) Southern Region Officers

Vice-President: Tim H. Murphy, Texas A&M University

Alternate Vice-President: Jason Peake, University of Georgia

Secretary: David Jones, North Carolina State University

Saturday, February 5

3:00 – 6:00 p.m. Registration..... Bayfront Hotel Lobby

Sunday, February 6

8:00 – 10:00 a.m Registration..... AmBank Foyer Room 225

8:00 – 9:00 a.m. Graduate Student Breakfast (preregistered). AmBank Bayview Ballroom D

9:15 – 9:45 a.m. Vespers..... AmBank Room 227

10:00 – 10:20 a.m. Opening Session..... AmBank Bayview Ballroom D

10:30 – 12:00 p.m. Concurrent Research Session I

 Session A: Agricultural Education: Improving Practice..... AmBankRoom 225D/E

[Relationships Between Agriculture Teaching Efficacy and Decision to Teach Among Agricultural Education Major](#)

Catrina Kennedy, Dr. John Ricketts, Dr. Dennis Duncan, University of Georgia

[Stress Levels of Agricultural Science Student Teachers and Cooperating Teachers](#)

Billy R. McKim, John Rayfield, Julie Harlin, Andrew Adams, Bart E. Gill, Texas A&M University

[The Relationship between Cooperating Teachers' Leadership Style and Student Teachers' Satisfaction Level](#)

Gaea Wimmer, Dr. Todd Brashears, Dr. Scott Burri; Texas Tech University

[Developing and Testing An Integrated Global Curriculum for an Introductory High School Agricultural Education Class](#)

Katrina R. Sharp, T. Grady Roberts, University of Florida

 Session B: Agricultural Education in Domestic

 and International Settings..... AmBank Room 227

[The Interactions of Instructional Efficacy, Motivational Orientations, and Adult Characteristics on Tenure in the \[State\] Extension Master Gardener Program](#)

Dr. Robert Strong, Texas A&M; Dr. Amy Harder, University of Florida

[A Balancing Act: Investigating Graduate Student and Advisor Relationships in Agricultural Leadership, Education, Extension, and Communications](#)

Bart E. Gill, Mark Russell, John Rayfield, Texas A&M University

[Stages of Concern Profiles of Agricultural Technical School Teachers in Egypt for Implementing Student Internships](#)

R. Kirby Barrick, Brian E. Myers, Mohamed M. Samy, University of Florida

[Corn Clubs: A Historical Inquiry](#)

Cassie Uricchio, Michael Coley, Gary Moore, North Carolina State University

Session C: Agricultural Education: Certification, Satisfaction
and Innovation..... Am Bank Room 226

[A Non-Traditional Route to Teacher Certification: Testimonies from Four Teacher Aspirants in Agricultural Education](#)

J. Shane Robinson, John J. Blackburn, Marshall A. Baker, Oklahoma State University

[An Analysis of North Carolina Public School Superintendents' Awareness of Biotechnology and the Future of Biotechnology Education](#)

Antoine Alston, Chastity Warren English, Mulumebet Worku, Guochen Yang, North Carolina A & T

[How Teacher Self-Efficacy and Job Satisfaction Changed During the Entry-Year of Employment of Agriculture Teachers: A Comparison of Certification Types](#)

J. Shane Robinson and M. Craig Edwards, Oklahoma State University

[Entry-level Technical Skills that Teachers Expected Students to Learn through Participation in the Supervised Agricultural Experience \(SAE\) Component of Secondary Agricultural Education: A Modified Delphi Study](#)

Dr. Jon W. Ramsey, Dr. M. Craig Edwards, Oklahoma State University

12:00 – 1:30 p.m. Luncheon AmBank Room 225C
1:30 – 2:30 p.m. SIGs..... Bayfront Ballroom D
2:30 – 4:00 p.m. Research Poster Session AmBank Foyer Room

[A Longitudinal Study of Challenges and Threats from County Extension Program Reviews](#)

Melissa Mazurkewicz, Amy Harder, University of Florida

[A Qualitative Approach to Multicultural Intelligences in Agricultural Education](#)

Jonathan A. Tubbs, Bryan J. Hains, Stacy K. Vincent, University of Kentucky

[A Qualitative Examination of Successful Collaboration Among Extension Agents and Agricultural Science Teachers: Examples, Barriers, and Enabling Factors](#)

Theresa Pesl Murphrey, John Rayfield, Julie Harlin, Kimberley A. Miller, Texas A&M University, Mission Viejo High School

[Agricultural Science Technology Needs: Agricultural Science Teachers Facing the Future in the Classroom](#)

Beth Ann Hunt, Don W. Edgar, Leslie D. Edgar, Kristin Pennington, Allyson McGuire, Casandra Cox, University of Arkansas

[An Analysis of Personality Types in Agricultural Leadership Programs](#)

Allison Britton, Hannah Carter, University of Florida

[Assessing the Impact of an Academic Internship](#)

Mark Kistler, Jackie Bruce, North Carolina State University

[Biodiesel Education: Effects on High School Students' Knowledge and Perceptions](#)

Jason A. Davis, Ryan Siebenmorgen, Don Edgar, George W. Wardlow, Donald Johnson, University of Arkansas

[Comparison of Approaches to Assess the Pre-Service Needs of Student Teachers in Supporting the SAE Portion of Agriculture Education and Demographic Differences that Impact Student Need](#)

Roger Hanagriff, John Rayfield, Lance Kieth, Dwayne Pavelock, Texas A&M University – Kingsville, Texas A&M University, Sam Houston State University

[Comparison of Participants' Satisfaction Levels of Food Safety Workshops Presented in U.S. and Mexico](#)

Brittini Drennan, Landi Woolley Campbell, Todd Brashears, Texas Tech University

[Critical Thinking Evidenced in Graduate Students Blogs](#)

Viviana Giraud, Holly Cain, Nicole Stedman, Gregory Gifford, University of Florida

[Difference in the Level of Synthesis of Leadership Life Skills Among 4-H Program Alumni](#)

Jessica Anderson, Jackie Bruce, North Carolina State University

[Do They or Don't They? Only their Agricultural Science Teachers Know for Sure](#)

Kirk Edney, Texas A&M University

[Education in a Technological World: An Analysis of Online Teaching Resources](#)

Bart E. Gill, Carla Jagger, Andrew Adams, Jeremy Falk, John Hall, Jed Bookman, Rachel Valenti, Katrina Swinehart, Texas A & M University, The Ohio State University

[Essential Agricultural Mechanics Skills for Beginning Agricultural Educators: A Delphi Approach](#)

P. Ryan Saucier, Billy R. McKim, John D. Tummons, Texas State University, Texas A&M University, University of Missouri

[Evaluating WLC Participants Perceived Knowledge of Authentic Leadership](#)

Chaney Mosley, Tom Broyles, Whitney Danker, Lindsey Thomas, Stephen Edwards, Virginia Polytechnic Institute and State University, National FFA Organization

[Exploring Teaching Efficacy of Pre Service Teachers Following the Student Teaching Internship Experience](#)

Bart E. Gill, T. Grady Roberts, Tim Murphy, Texas A & M University, University of Florida

[Knowledge and Perceptions of Agriculture in Tennessee through Fall Agritourism](#)

Jessica J. Poore, Bryan Q. Patterson, University of Tennessee

[Leadership Styles of Two-Year Associate’s Degree Students in Agriculture](#)

Holly J. Kasperbauer, Jill N. Casten, Pavli Mykerezi, Joe Guthrie, Rick Rudd, Virginia Polytechnic Institute and State University

[Long-term Goals: Assessing Results of Teacher Participation on Their Students](#)

Quisto Settle, Tracy Irani, University of Florida

[New Competencies to be Successful as an Extension Agent in Present Context](#)

Dona Lakai, K. S. U. Jayaratne, Gary Moore, Mark J. Kistler, North Carolina State University

[Practices for Managing Animal Project Centers](#)

Steven (Boot) Chumbley, Texas Tech University

[Self-Perceived Levels of Importance of Agricultural Mechanics Laboratory Management Competencies by Agricultural Education Pre-Service Teachers](#)

P. Ryan Saucier, Justin L. Killingsworth, John D. Tummons, Texas State University and the University of Missouri

[Student Teachers Reflection on Indicators of Engaged Learning](#)

Christy Witt, Scott Burris, Texas Tech University

[Teaching Beliefs of Excellent Undergraduate Professors](#)

Aaron Giorgi, T. Grady Roberts, University of Florida

[Teaching Locally, Engaging Globally: Examining Faculty Pre-Trip Attitudes and Beliefs](#)

Jessica Kochert, Amy Harder, T. Grady Roberts, Nicole Stedman, Marta Hartmann, University of Florida

[Terminal Publication of AAAE Conference Papers](#)

Nathan Conner, Christopher T. Stripling, T. Grady Roberts, University of Florida

2:30 – 3:30 p.m.	BREAK	AmBank Foyer Room
4:00 – 6:00 p.m.	SAAS General Session	Bayfront Nueces Ballroom A
6:00 p.m. – till	SAAS Super Bowl Reception	Brewster Street Icehouse

Monday, February 7

8:00 – 10:00 a.m.	Registration	AmBank Foyer Room
8:30 – 10:00 a.m.	Concurrent Research Session II	

Session D: Agricultural CommunicationsAmBankRoom 225A/B

[Impact of Selected Factors on Perceived Efficacy of Twitter Use by Agricultural Communicators](#)

Dr. Alyx Shultz, Murray State University; Dr. Susan Duncan, Dr. Cindy Akers, Dr. Scott Burris, Dr. Todd Brashears, Texas Tech University

[Agricultural Communications Training Needs Among \[State\] Agricultural Educators](#)

Ashley Stockamp, Dr. Shelly Sitton, Denise George, Oklahoma State University

[Comparisons of Agriculture Instructor and Student Perceptions of Social Media in Education](#)

Quisto Settle, Dr. Ricky Telg, Lauri M. Baker, Dr. Tracy Irani, University of Florida; Dr. Tracy Rutherford, Dr. Emily Rhoades, Texas A&M University

[Information and Communication Technology Tasks Required in Undergraduate Agriculture Courses](#)

Cassandra Cox, Leslie Edgar, Karisha Munise, Don Johnson, University of Arkansas

Session E: Agricultural Education: Math and Technology.....AmBank Room 225 D/E

[Enhancing Collaboration among Math and Career and Technical Education Teachers: Is Technology the Answer?](#)

A. Christian Morgan, University of Georgia; Brian A. Parr, Auburn University; Nicholas E. Fuhrman, University of Georgia

[Animation: Friend or Foe in Today's Classrooms?](#)

Ron D. Koch, Dr. Don W. Edgar, Dr. George W. Wardlow, University of Arkansas

[Teachers' Use of Interactive Whiteboards in the Secondary Agricultural Education Classroom: Measures of Self-efficacy, Outcome Expectations, Interest and Selected Relationships](#)

J.C. Bunch, Dr. J. Shane Robinson, Dr. M. Craig Edwards, Oklahoma State University

[Florida Preservice Agricultural Education Teachers' Mathematics Ability and Efficacy](#)

Christopher T. Stripling, Dr. T. Grady Roberts, University of Florida

Session F: Agricultural Education: Enhanced Learning..... Am Bank Room 226

[Determining the Effect of a Science-Enhanced Curriculum on Agricultural Content Knowledge: A Causal Comparative Study](#)

J. Chris Haynes, Dr. J. Shane Robinson, Dr. M. Craig Edwards, Dr. James P. Key, Oklahoma State University

[Practical Implications for the Experiential Learning Theory in Agricultural Education: A Conversation with Dr. David A. Kolb](#)

Marshall A. Baker, J. Shane Robinson, Oklahoma State University

[Effects of Inquiry-based Agriscience Instruction on Student Argumentation Skills](#)

Dr. Andrew C. Thoron, Dr. Brian E. Myers, University of Florida

[Does Cognitive Diversity in Groups Really Enhance Application?](#)

Alexa J. Lamm, Catherine Shoulders, Dr. T. Grady Roberts, Dr. Tracy Irani, Dr. Lori Snyder, Dr. Joel Brendemuhl, University of Florida

10:00 – 10:30 a.m.	BREAK.....	AmBank
10:30 – 11:45 a.m.	SR AAAE Business Session I.....	AmBank Room 225 D/E
12:30 – 1:30 p.m.	Luncheon.....	AmBank Room 225 A/B
1:45 – 2:45 p.m.	Business Session II	AmBank Room 225 D/E
3:00 – 4:30 p.m.	InnovativePoster Session II.....	AmBank Foyer Room

[4-H and Facebook: Can they Co-Exist?](#)

Jessica Anderson, K.S.U. Jayaratne, North Carolina State University

[A Little Birdie Told Me: Using Twitter as a Discussion Tool](#)

Lauri M. Baker, Christy Chiarelli, Quisto Settle, University of Florida

[A Mobile Classroom for Visual Communications on the Road in \[State\]: Using High School Students to Create Video and Photo Projects to Promote Agriculture](#)

Kristin Pennington, Leslie D. Edgar, Don W. Edgar, Casandra Cox, Allyson McGuire, Beth Ann Hunt, University of Arkansas

[A Model for Integrating Critical Thinking and Emotional Intelligence into Leadership Curricula](#)

Jason Davison, Nicole Stedman, University of Florida

[A Model for Program Planning and Evaluation for School-based Agriscience Education](#)

Christopher M. Estep, Andrew C. Thoron, University of Florida

[A Philosophical View for Using Second Life™ as a Teaching and Learning Tool](#)

Allyson McGuire, Leslie D. Edgar, Don W. Edgar, Kristin Pennington, University of Arkansas

[A Qualitative Evaluation of a Cross-Cultural Immersion Program for Extension Educators](#)

Jenna Brown, Maria Navarro, Dennis Duncan, Nick Fuhrman, University of Georgia

[Better Teamwork by Knowing Yourself & Other's Personalities](#)

David Jones, North Carolina State University

[Breaking Barriers for Beginning Hispanic Farmers and Ranchers](#)

Stephanie Herreros, Robert Williams, Jose Lopez, Curtis Jones, Mario Villarino, Texas A&M University-Commerce

[By Choice, Not By Chance Art Gallery Exhibit](#)

Bill Riley, Stacy Vincent, University of Kentucky

[Collegiate Leadership In Agricultural Student Organizations: Developing A Motivational Perspective](#)

Andrea Andrews, Nicole Stedman, Greg Gifford, University of Florida

[Development of an Electronic Clearinghouse of Renewable Energy Curriculum for Secondary Agricultural Education: A Partnership of Two Departments](#)

Joey Blackburn, Marshall Baker, Shane Robinson, Craig Edwards, Ray Huhnke, Oklahoma State University

[Differentiated Instruction for the Learning Disabled in the Ag Science Classroom: Agricultural Science Teachers' Professional Development](#)

Michelle Pavelock, Theresa Murphrey, Texas A&M University

[Evaluation Results of Pet Awareness With Children Animal Bite Prevention Program](#)

Joel D. Ray, Michael E Newman, Mississippi State University

[Giving a Face to your Agricultural Leadership Program](#)

Avery Culbertson, Micah D. Scanga, Hannah Carter, University of Florida

[Incorporating Preparatory Exams into a Dual Credit Course Curriculum: Preparing Students for Computerized College Testing and Increasing Post Secondary Credit Success Rates](#)

Alanna Neely, Cliff Ricketts, Warren Gill, Middle Tennessee State University

[Incorporating Socioscientific Issues into Agriculture Teacher Education Curriculum](#)

Adrienne N. Gentry, Catherine W. Shoulders, Brian E. Myers, University of Florida

[Integrating 21st Century Technology in Secondary Agricultural Education Classrooms: GPS Professional Development Carousel Workshop](#)

J. Shane Robinson, Jon W. Ramsey, Oklahoma State University

[Integrating Service-Learning into International Study Abroad Programs: Easy as PIE](#)

Joelle Petrosky, Jennifer Williams, Texas A&M University

[Leveraging Web 2.0 Programs to Increase Academic Retention](#)

Michelle Santiago, Michael Lau, Art Wolfskill, Maud Roucan-Kane, Sam Houston State University

[Maximizing Preservice Teacher Education: The Pre-Internship Block](#)

Catherine W. Shoulders, Eric Rubenstein, Brian E. Myers, University of Florida

[Meet, Greet, Compete and Eat: Learning by Doing- Leadership Contest](#)

Wendie Clubine, Robert Williams, Texas A&M University- Commerce

[Paving a Road to Success with the Agriculture /Academic Integration Project](#)

Yvette Smith, Diana L. King, University of Georgia

[Preparing Undergraduate Students for Agricultural Advocacy](#)

Chaney Mosley, Keyana Ellis, Michelle Greaud, Lisa Hightower, Eric Kaufman, Virginia Polytechnic Institute and State University

[Preparing Young Leaders for Sustainable Agriculture Practices in West Virginia](#)

John Lockhart, Matt Coe, Douglas D. LaVergne, West Virginia University

[Sam's Big Adventure: An Innovative Educational Intervention for Children](#)

Joel D. Ray, Susan Seal, Michael Newman, Mississippi State University

[Simulation: Innovations toward Bridging Social Cultures through Agricultural Education](#)

Jonathan A. Tubbs, Stacy K. Vincent, Bryan J. Hains, University of Kentucky

[The Lesson Plan Blitz: Assisting Pre-Service Teachers Through Their Zone of Proximal Development](#)

Cory Epler, Thomas Broyles, Virginia Polytechnic Institute and State University

[Tractor Technician Career Development Event: Classroom Instruction to Career Opportunities](#)

P. Ryan Saucier, G. Curtis Langley, William R. Harrell, John D. Tummons, Texas State University, University of Missouri, Sam Houston State University

[Using Professional Identity to Enhance Agriculture Teacher Professional Development](#)

Catherine W. Shoulders, Brian E. Myers, University of Florida

[You are Fired. Using Reality Television to Enhance Student Engagement and Motivation Through Problem Based Learning](#)

Christopher T. Stripling, Andrew C. Thoron University of Florida, University of Illinois

5:30 – 8:30 p.m. DINNERU.S.S. Lexington

Bus leaves Bayfront Tower Hotel and will make two runs to dinner location about 20 minutes apart

Tuesday, February 8

8:30 – 9:30 a.m. Concurrent Research Session III

Session G Agricultural Education: A broader view..... Bayfront Corpus Christi Ballroom B

[A Gender Analysis of Job satisfaction levels of Agricultural Education Teachers in Georgia](#)

Donald Gilman, Jason Peake, University of Georgia; Brian Parr, Auburn University

[An Examination of Trust-related Behaviors Important to Agricultural Stakeholders](#)

Kelsey Hall, Dr. David Doerfert, Dr. Courtney Meyers, Dr. Jon Ulmer, Jarrott Wilkinson, Texas Tech University

[Proposed Solutions Toward Inclusive Agricultural Education Programs](#)

Dr. Douglas D. LaVergne, West Virginia University; Dr. Alvin Larke, Jr., Texas A&M University; Dr. Wash A. Jones, Prairie View A&M University; Dr. Chanda D. Elbert, Texas A&M

[Multicultural Competence: A Case Study of Teachers and Student Perceptions](#)

Stacy K. Vincent, University of Kentucky; & Robert M. Torres, University of Arizona

Session H Extension and Outreach..... Bayfront Corpus Christi Ballroom A

[Examining Adult Participation in a Statewide Nonformal Horticultural Program](#)

Dr. Robert Strong, Texas A&M University; Dr. Amy Harder, University of Florida

[Refocusing Evaluation Efforts: Evaluating Extension Programs for Use Can Enhance Accountability Efforts](#)

Alexa J. Lamm, Dr. Glenn D. Israel, Dr. Amy Harder, University of Florida

[A Quantitative Analysis of the Efficacy of a Cross-Cultural Immersion Program for Extension Educators](#)

Jenna Brown, Dr. Maria Navarro, Dr. Dennis Duncan, Dr. Nick Fuhrman, University of Georgia

[4-H Volunteers Intent to Support Youth with Disabilities: An Elicitation Study](#)

Ms. M. Jo Monroe, Dr. Curtis R. Friedel, Louisiana State University

Session I Agricultural Education: Laboratories
and Mechanization..... Bayfront Corpus Christi Ballroom C

[Economic Impact of Agricultural Mechanics Competition Projects in \(State\) and Factors that Predict Chapter Investment Value: State Returns from 2009-2010](#)

Roger Hanagriff, Gary Briers, John Rayfield, Tim Murphy, Texas A&M University; Doug Kingman, Sam Houston State University

[Student Perceptions of Instructional Methods Towards Alternative Energy Education](#)

Clayton W. Sallee, Dr. Don W. Edgar, Dr. Don M. Johnson, University of Arkansas

[Teachers' Use of Agricultural Laboratories in Secondary Agricultural Education](#)

Catherine W. Shoulders, Dr. Brian E. Myers, Oklahoma State University

[Agricultural Mechanics Laboratory Safety: Professional Development Needs of Kentucky School-Based Agricultural Educators](#)

Dr. P. Ryan Saucier, Texas State University; Dr. Stacy K. Vincent, University of Kentucky; Dr. Ryan G. Anderson, Iowa State University

9:30 – 10:00 a.m.	BREAK.....	Bayfront Corpus Christi Ballroom A
10:00 – 11:15 a.m.	Professional Development.....	Bayfront Corpus Christi Ballroom A
11:30 – 1:30 p.m.	Awards Luncheon.....	Bayfront Corpus Christi Ballroom B

Session A: Agricultural Education: Improving Practice

**Relationships between Agriculture Teaching Efficacy and Decision to Teach Among
Agricultural Education Majors**

Catrina Kennedy, Dr. John Ricketts, Dr. Dennis Duncan, University of Georgia

Abstract

This study implemented a correlational research design to identify relationships between agriculture teaching self-efficacy and decision to teach among undergraduate agricultural education majors at the University of Georgia and Middle Tennessee State University who had not completed their student teaching internship (N = 63). Teaching self-efficacy was studied through the domains of classroom, FFA, and SAE since agricultural education teachers have a set of skills they must master in addition to the skills needed by general educators. Results indicated self-efficacy was highest among the SAE domain, followed by FFA and classroom domains respectively. Most participants planned to teach if the perfect opportunity presented itself, and there was a moderate relationship between FFA teaching efficacy and decision as well as SAE teaching efficacy and decision to teach.

Introduction

From 1984, until the early 90's, the number of students who entered the agricultural education profession decreased (Georgia FFA, 2009). During this decade, there were consistent job shortages every year. According to Wolf (2008), there is still a dramatic shortage of agricultural educators on a national level. In 2007, Kantrovich estimated the nationwide agricultural educator deficit to be 38.5 percent. Due to this shortage approximately 40 agricultural programs closed in 2007 (Kantrovich, 2007). Perhaps most concerning and/or exciting is the fact leaders of education want to add more programs, thus seemingly enhancing the teacher shortage problem (Team AgEd, 2007). Exactly where is the breaking point?

The question must be asked, "Why does there exist such a shortage of agricultural education teachers?" Ingersoll (2001) stated that more than one-third of beginning teachers leave during the first three years, and almost half of teachers leave within the first five years, but why? Previous research has identified a plethora of problems facing agricultural educators: classroom management, FFA responsibilities, developing curriculum and time management (Garton & Chung, 1996; Mundt & Connors, 1999; Myers, Dyer, & Washburn, 2005). Novice teachers typically have more difficulty in the classroom because they lack experience, which leaves them feeling confused, frustrated, and isolated (Croom, 2003). If those same teachers had higher teacher self-efficacy they would find more satisfaction within their career choice, and they would ultimately be better teachers (Bandura, 1994). While the question of retention is an important one for bridging the teacher shortage divide, this study will focus on the other part of the problem – attracting talented and experienced students to the career of agricultural education.

There are numerous reasons why agricultural educators choose their profession. If a student has a good experience with their agricultural educator they may choose the same profession. Kotrlik and Harrison (1987) determined that the agriculture teacher is a major influence on career decisions, and others have argued that FFA members have a stronger belief than non-members that their agriculture classes are preparing them for the future (Talbert & Balschweid, 2004). Teacher self-efficacy can also be linked to career decision-making processes among students. According to Ashton and Webb (1986) efficacious teachers have more successful students. One may even argue that the more successful a student becomes in a given career education program, the more likely a student is to choose that profession as a career. On the other hand, students may use decision-making strategies that are emotionally based, using personal reasons and intuition rather than the information gathering and goal-setting recommended by career decision-making experts (Hurley & Thorp, 2002).

Another reason for choosing the agricultural education profession may lie in a person's belief they have the skills necessary to be a successful teacher. This self-belief to do well is referred to as self-efficacy. Bandura (1986) defines self-efficacy as a "person's belief in their own ability to be successful" (p. 77). Teacher self-efficacy means, "that person [teacher] must have a true belief that they can affect a student's life and have an impact" (Bandura, 1997, p. 77). In order to increase teacher self-efficacy it is important that students have successful experiences, which increase self-confidence. By giving future teachers a better perspective of teaching and how their students will learn and behave they will have better teaching self-efficacy (Darling-Hammond & Bransford, 2005).

Student teaching plays a role in teacher self-efficacy (Woolfolk, 2000), and high school agricultural education experiences have also been found to be associated with self-efficacy (Priest, 2008). Confident future teachers sometimes choose agricultural education because of the familiarity of the FFA portion of the total program, but there are many parts and phases of a successful agriculture program - the ability to be efficacious about all areas can be overwhelming. In fact, everything an agricultural education teacher is expected to do can be overwhelming to even a veteran teacher. An agricultural educator has many responsibilities such as livestock shows or Career Development Events (Talbert, Camp, & Heath-Camp, 1994). In the absence of organized events, a successful agricultural education teacher is typically preparing their students for the next event, which often leads to long working days as well (Croom, 2003).

The work of an agricultural educator also has great benefits. Students and their parents find the value of agricultural education through FFA participation, curriculum offerings, and hands-on learning. Students and parents believe that agriculture can be a viable career opportunity. Agricultural education programs are high in quality with regards to the education that they offer (Osborne & Dyer, 2000). Agriculture is essential to daily lives and it is vital that agricultural educators continue to teach its importance. This study will determine the relationship between agricultural education student experiences, their respective agriculture teaching self-efficacy, and decision to teach. Understanding these relationships may help build better agriculture teachers.

Literature Review/Theoretical Framework

According to Bandura (1994), if a person has a high teacher self-efficacy they will have the ability to withstand more, resulting in their retention in the profession. Self-efficacy in classroom management is directly related to teacher burnout (Croom, 2003; Wolf, 2008). Teacher self-efficacy has been directly correlated with student motivation, classroom management and teacher evaluations (Woolfolk, 2000).

The Social Cognitive Theory explains how people acquire and maintain certain behaviors (Bandura, 1986). There are four core features according to Bandura. They are intentionality, forethought, self-reflectiveness, and self-reactiveness (Bandura, 2004). If choosing to teach or choosing to remain teaching is a behavior, then cognitive beliefs about teaching or environmental events such as secondary agricultural education experience ought to influence decision to teach.

According to Bandura there are several sources of information that shape self-efficacy - beliefs, personal performance accomplishments, learning through others, social pressure (i.e. support and encouragement), physiological states and/or reactions (Bandura, 1977, 1986). Typically, personal experiences and the success of that experience leads to stronger self-efficacy (Bandura, 1986; Niles & Harris-Bowlsbey, 2005).

Park and Rudd (2005) argue that an agriscience teacher has an effect on a student's career choice by combining the Social Cognitive Theory and Expectancy Theory (Figure 1). Because students spend more time with agricultural educators they are exposed to career choices which the teacher influences. In addition, agricultural educators have higher expectations of their students which may encourage a student's career decision (Park & Rudd, 2005).

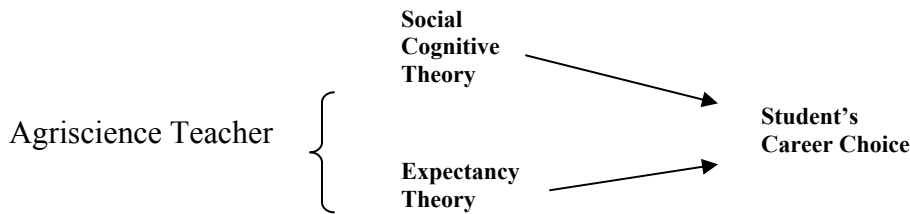

Figure 1. Influence of Agriscience Teacher's Career Modeling and Expectations on Career Choice (Park & Rudd, 2005)

Vroom's (1964) expectancy theory is based on a person's motivation to finish a task based on their views of that task. The theory suggested that people consciously choose an activity based on previous encounters with that task. The expectancy theory assumes that attaining pleasure from an experience allows you to continue doing that task. Thus, if a person enjoys their job they, according to the expectancy theory, will continue to do the job as long as they are getting pleasure from it (Vroom, 1964). The expectancy theory assumes if a person puts forth effort and is rewarded they will reach their goals and have higher motivation.

The social cognitive career theory (SCCT) was developed by Lent, Brown and Hackett (1994) and seeks to explain the interplay among many constructs that are described by other existing career development theories (as cited in Priest, 2008). The SCCT theory was derived primarily from Bandura's (1986) social cognitive theory and builds upon Krumboltz's (1976)

hypothesis that cognitive factors play an essential role in career development and decision making behavior. Social cognitive career theory posits that learning experiences (which may include behaviors displayed in extracurricular activities) influences academic and career interest, choice, and development (Priest, 2008). Priest developed the following conceptual model to guide research related to career decisions among those in agricultural education. This study focuses on the learning experiences (Activities), self-efficacy (specifically agriculture teaching self-efficacy), and decision to teach (Choice Actions).

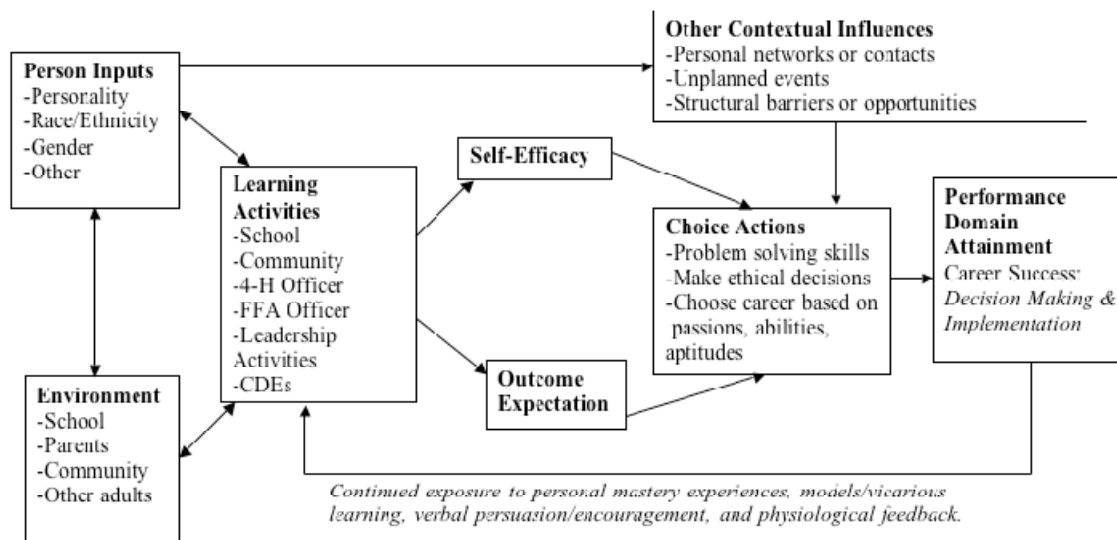

Figure 2. Model of career decision-making for students in agricultural education.

Purpose and Objectives

The goals of this study were to identify pre-service agricultural education students' experiences, teaching self-efficacy, and decision to teach. Ultimately, the purpose was to document the impact of teacher self-efficacy on undergraduate career choice - specifically the choice to teach agricultural education. Objectives of the study were as follows:

1. Identify student experiences related to agricultural education;
2. Describe student expectations regarding decision to teach and other plans after graduation;
3. Describe perceived teacher self-efficacy of undergraduate agricultural education majors; and
4. Describe the relationship between agricultural education student experiences, teacher self-efficacy and decision to teach.

Methods and Procedures

The study was a descriptive survey that implemented a correlational research design. It was a census of all University of Georgia and Middle Tennessee State University agricultural education undergraduates ($N = 63$) who were taking classes in the fall of 2009. Because the study was a census, the results may not be generalized beyond the population. However, pre-service agricultural education majors are very similar from one teacher education institution to another;

therefore, generalization with caution may contribute to the knowledge base and more importantly teacher recruitment/retention issues beyond the states included in this study.

Data was collected by professors in Agricultural Education using a teacher self-efficacy instrument developed by Wolf (2008). The instrument divided teacher self-efficacy into the following domains: classroom, FFA, and SAE. In addition to the self-efficacy instrument, a demographic/experience survey was utilized. Wolf's instrument, specifically designed for agricultural educators, was developed from a cadre of research instruments (Duncan & Ricketts, 2006; Duncan, Peake, Ricketts, & Uessler, 2005; Garton & Chung, 1996; Joerger, 2002; Roberts & Dyer, 2004) as well as the general education community (Wolf, 2008; Tschannen-Moran & Woolfolk Hoy, 2001).

The scale is based on the *Teachers Sense of Efficacy Scale* which uses a nine point summated rating scale (Wolf, 2008; Tschannen-Moran & Woolfolk Hoy, 2001). Subjects responded to the items based on their level of capability (1=Low capability; 9 = A great deal of capability). The instrument asked subjects their perceived self-efficacy on specific tasks (Wolf, 2008). Wolf's reported reliability for each domain was: classroom .715, FFA .705, and SAE .696.

A demographic instrument was also administered that determined agricultural education experiences and decision to teach variables. This instrument did not require reliability estimates, but it was checked by a panel of experts at the two universities for content and face validity.

University of Georgia and Middle Tennessee State University professors distributed the surveys to all agricultural education majors. Emails, phone calls, and in some cases face to face visits were made with the non-respondents of the initial survey to collect as many responses as possible. Of the 63 students enrolled in agricultural education at the two universities, 55 (87%) completed the survey. Due to the similar make-up of the students at both institutions, representativeness of the responders was assumed and non-response was not a concern and therefore not addressed.

Findings

The ages of the all-Caucasian group of students ranged from 19-43 with the average age of 21. All of the individuals that completed the survey had no teaching experience other than practice teaching. Thirty-two (58%) of the respondents were female while twenty-three (42%) were male. Eighty-seven percent of the respondents were FFA members, and the 34% received their State FFA Degree while 20% received their American FFA Degree. Of the 87% of FFA members, 62% were FFA Officers. In addition, future teachers at both universities had at least part-time employment in the agricultural industry. In fact, 23% of the respondents had at least a part-time job revolving around agriculture while 56.4% had a full time job in agriculture for some length of time (Table 1).

Table 1
Future Teachers' Relevant Experiences (N = 55)

	<i>f</i>	<i>P</i>
FFA Member		
No	7	13
Yes	48	87
Highest FFA degree earned		
No FFA degree	8	15
Greenhand FFA degree	4	7
Chapter FFA degree	6	11
State FFA degree	19	35
American FFA degree	11	20
FFA Officer		
No	14	26
Yes	34	62
Agricultural Work Experience		
No experience	4	7.3
Mostly a-vocational	7	12.7
Part-time employment	13	23.6
Full-time employment (< 6 months)	11	20.0
Full-time employment (≥6 months)	20	36.4

Note. *f*=frequency, *P*= percentage

Fifty-five percent of the respondents said if they were offered an agricultural science position in an upstanding community they would take the job (Table 2).

Table 2
If You Were Offered a Suitable Agricultural Science Teaching Position in a Community of Your Choice, would you take it?

	<i>f</i>	<i>P</i>
Definitely yes	30	55
Yes	9	16
Probably Yes	9	16

Unsure	6	11
No	1	2

In a separate question about graduation plans in general, just over 50% indicated they would go into teaching agriculture after graduation, but wanted to continue their education in graduate school (Table 3).

Table 3
Plans after Graduation

	<i>f</i>	<i>P</i>
Teach Agricultural Science	21	38.2
Go to Graduate School	14	25.5
Unsure	9	16.4
Other Employment	4	7.3
Teach Ag and Go to Graduate School	7	12.7

Respondents in this study indicated that they had a high self-efficacy on most items. The overall summated mean for teacher self-efficacy in agricultural education was 7.12. Respondents reported the lowest levels of teacher self-efficacy in the classroom domain ($M = 6.96$) when compared to the FFA ($M = 7.14$) and the SAE ($M = 7.27$) domains.

In the classroom domain, respondents indicated they had high capability on most items. Over 75 percent of the respondents reported high levels of capability on the following items: using a variety of techniques, conducting field trips, providing alternate explanations when students are confused, utilizing computers in teaching, effectively conducting field trips, and providing appropriate challenges for very capable students (Table 4). Two items had more low levels of capability than the others: managing a horticulture laboratory/greenhouse (low= 9%), and managing an agricultural mechanics laboratory (low= 16%).

In the FFA domain, respondents also indicated they had high capability on most items (Table 5). The summated mean for the FFA domain was 7.14 indicating “Quite a Bit of Capability.” Ninety-one percent of the respondents reported high levels of capability on the items: assist students in planning FFA Banquets, advising FFA meetings, assisting students in developing community service projects, assisting students in planning FFA degree applications and assisting students with FFA proficiency applications. However, some items had more low levels of capability than the others: assisting students in planning FFA chapter activities, training chapter officer teams, assisting students in recruiting members, assisting students in developing an effective public relations program, utilizing an Alumni, and coaching leadership based teams.

Table 4

Teacher Self-Efficacy in Classroom Domain

<i>What is your level of capability to:</i>	<i>Low</i>	<i>Moderate</i>	<i>High</i>
Use a variety of teaching techniques	0	16/29	41/75
Provide alt. explanations when students are confused	0	17/31	42/76
Respond to difficult questions from my students	1/1	20/36	38/69

Utilize computers in my teaching	3/5	14/25	41/75
Implement a curriculum in agriculture	3/5	20/36	36/65
Evaluate student learning	1/1	26/47	32/58
Motivate students to learn	0	20/36	36/65
Utilize multimedia in my teaching	2/3	27/49	36/65
Create lesson plans for instruction	0	21/38	34/62
Use a variety of assessment strategies	0	20/36	38/69
Craft good questions for my student	0	18/33	39/71
Effectively conduct field trips	2/3	11/20	46/84
Implement alternative strategies in my classroom	1/1	12/22	37/67
Teach students to think critically	1/1	16/29	32/58
Manage student behavior	0	23/42	32/58
Teach students with special needs	2/3	19/35	36/65
Provide appropriate challenges for very capable students	2/3	15/27	42/76
Manage an agricultural mechanics laboratory	9/16	14/25	36/65
Manage a horticulture laboratory/greenhouse	5/9	18/33	39/71
Adjust my lessons to proper level for individual students	2/3	18/33	40/73

Note. *f*=frequency, *P*= %, Low=1-3, Moderate= 4-6, High=7-9. 1=No Capability, 3=Very Little Capability, 5=Some Capability, 7=Quite a Bit of Capability, 9=Great Deal of Capability

Table 5

Teacher Self-Efficacy in FFA Domain

<i>What is your capability to:</i>	<i>Low</i>	<i>Moderate</i>	<i>High</i>
Assist students in planning FFA banquets	0	7/12	51/93
Assist students in facilitating FFA fundraising activities	2/3	14/23	45/82
Supervise students during FFA trips and activities	1/1	15/27	45/82
Advise FFA Meetings	2/3	9/16	50/91
Assist students in planning FFA chapter activities	4/7	6/10	49/89
Assist students in developing community service projects	3/5	6/10	50/91
Recruit new FFA members	3/5	10/18	44/80
Coach leadership based CDE teams	6/11	19/35	34/62
Train a chapter officer team	4/7	8/33	38/69
Assist students in recruiting new FFA members	7/12	12/22	40/73
Assist students in developing an effective PR program	4/7	14/25	41/75
Assist students in preparing a Program of Activities	2/3	10/20	47/85
Coach skills based CDE teams	3/5	18/33	38/60
Assist students in preparing FFA degree applications	3/5	6/11	50/91
Assist students in preparing FFA proficiency applications	3/5	8/15	50/91
Utilize FFA Alumni	4/7	7/12	44/80
Utilize a Program Advisory Board	3/5	6/11	49/89

In the SAE domain, respondents indicated they had high capability on most items. The summated mean for the SAE domain was 7.27 (Table 6). Respondents reported the highest levels of teacher self-efficacy in the SAE domain when compared to the FFA and the classroom domains. Over 90 percent of the respondents reported high levels of capability on the items: assist students in receiving recognition for SAE and provide career exploration opportunities for

students. However, the items supervising SAE projects, utilizing the community to develop SAE, and motivating students to have SAE's projects (low= 12%) yielded the most response in terms of low capability.

Table 6
Teacher Self-Efficacy in SAE Domain

What is your level of capability to:	Low	Moderate	High
Assist students in receiving recognition for SAE	2/3	7/12	50/91
Provide career exploration opportunities for students	2/3	6/10	51/93
Conduct home/SAE visits	3/5	11/20	45/82
Supervise student placement SAE programs	4/7	11/20	44/80
Show students the value of SAE programs	3/5	13/24	44/80
Assist students in keeping SAE records	3/5	17/31	39/71
Supervise student entrepreneurship SAE programs	3/5	14/25	42/76
Make recommendations for students' SAE projects	4/7	11/20	44/80
Supervise student production SAE programs	5/9	9/16	45/82
Utilize resources to make recommendations to SAE	3/5	10/18	46/84
Motivate students to have an SAE program	7/12	10/18	43/78
Utilize the community to develop SAE opportunities	5/9	7/12	46/84
Develop SAE opportunities for students	4/7	8/15	47/85

All independent variables including demographics were entered into a multiple regression formula to determine what contributes to decision to teach beyond teacher self-efficacy, and none of the independent variables contributed to a decision to teach.

Davis (1971) correlations for Pearson's R were used to describe the degree and direction of linear relationships between decision to teach and agricultural teaching self-efficacy. Davis' correlations are as follows: .01 to .09 = negligible association, .10 to .29 = low association, .30 to .49 = moderate association, .50 to .69 = substantial association, .70 or higher = very strong association. There was no significant correlation between classroom self-efficacy and decision to teach. However, a moderate association was identified for FFA teaching efficacy ($r = .35$) and SAE ($r = .31$) teaching efficacy and decision to teach (Table 7).

Table 7
Correlation between Teacher Self-Efficacy and Decision to Teach.

Indicant	1	2	3	4
Decision to Teach ¹		.20	.35**	.31*
Classroom teaching efficacy ²			.43**	.35**
FFA teaching efficacy ³				.80**
SAE teaching efficacy ⁴				

Note. * $p < .05$; ** $p < .01$

Conclusions/Implications/Recommendations

All respondents were undergraduate agricultural education majors from the University of Georgia and Middle Tennessee State University. Respondent's ages ranged from 19 to 43. The average age of the undergraduate agricultural education students was 21 and the majority of them participated in the National FFA Organization. A majority of the undergraduate agricultural education majors did not plan to go straight into teaching upon graduating with their B.S degree but plan to further their education. Thirteen percent of the respondents were not involved with the FFA in secondary education but still had intentions on becoming an agricultural educator.

The primary dependent variable of interest was decision to teach. Only 48 percent of the respondents indicated they would take a job if offered a job in the community of their choice, and only 38 percent planned on teaching upon graduating with their bachelor's degree.

Undergraduate agricultural education majors perceived themselves to be successful. Respondents reported the highest level of teacher self-efficacy in the SAE domain and the lowest level of teacher self-efficacy in the classroom domain. Respondents in this study indicated they had high levels of capability on most items in the classroom domain. Two items had noticeably lower ratings in the following areas: the management of a horticulture laboratory/greenhouse and the management of an agricultural mechanics laboratory.

For the FFA domain, respondents reported a moderate level of capability. The highest items consisted of: planning FFA banquets, supervise students while on FFA trips, and train the FFA officers. The items that recorded lowest were: completing proficiency applications and working/utilizing an advisory board and alumni. In the SAE domain, respondents had high levels of self-efficacy in the following areas: provide career explorations, develop SAE opportunities for students, and make recommendations for student projects. The items that were reported the lowest were: supervise SAE programs and conduct home visits.

There was no relationship between agricultural education experiences and decision to teach, but there was a relationship between all three domains of agricultural teacher self- efficacy and decision to teach. Demographics and agricultural education experiences are not factors regarding career choice among pre-service teachers, but teaching self-efficacy in FFA and SAE is. How does one develop teaching efficacy in these areas without agricultural education experiences? Researchers believe perhaps the right questions regarding agricultural education experiences were not asked in this study.

Undergraduates that were involved with agricultural education previously had a higher self-efficacy within the FFA domain. Undergraduates who planned to teach had a higher teacher self-efficacy. The biggest concern with the future teachers is within the classroom domain and managing horticultural laboratory/greenhouse and agricultural mechanics laboratory. It is recommended that the teacher educators at each university offer more curricular opportunities in greenhouse management and agricultural mechanics.

The majority of the respondents said they wanted to teach agricultural science upon graduation although the majority of the respondents want to continue their education before teaching. The quality of previous experiences, FFA involvement, FFA Degrees and being an FFA Officer, had a positive relationship with overall teacher self-efficacy.

It is imperative to recruit additional students into programs of agricultural education to insure that agricultural education positions are filled each year. Approximately 70 percent of qualified candidates become teachers nationally (Kantrovich, 2007), 35 percent in the Wolf (2008) study as compared to the 38 percent within this study. This study shows that 38 percent of the respondents will with high self-efficacy. It should also be noted all of the respondents were Caucasian. Therefore, faculty at both universities must improve their recruiting programs so African American and Latino students are interested in agricultural education.

The majority of the undergraduate agricultural education students at the University of Georgia and Middle Tennessee State University have a high teaching self-efficacy. The classroom domain was the lowest while SAE was the highest. Having high teacher self-efficacy has been directly tied to success in the classroom. Perhaps incorporating more early field-based experiences into the university curriculum would assist in boosting the respondents' self-efficacy.

Within the SAE domain respondents did not feel comfortable doing home visits or motivating students to have an SAE. Agricultural education relies upon activities in all areas of the "Total Program" model. Therefore, if prospective agricultural educators are not comfortable with these SAE areas it may be in the best interest of teacher educators to implement SAE related curricular projects at the collegiate level with local secondary school systems. Within the FFA domain, respondents did not feel comfortable working with alumni or an advisory board. Again, teacher educators must consider implementing a component within the undergraduate curriculum that brings local advisory boards and agricultural education majors together.

Lastly, only 38 percent of the population with high self-efficacy indicated they plan to teach upon graduation. The other 48 percent either planned to pursue higher education or pursue another career opportunity. It is imperative that teacher educators at each university increase the number of BS degree candidates that plan to teach. If the trend continues for people to pursue higher degrees, then the short-term shortage of agricultural educators will continue to increase. One option to consider is requiring all agricultural education majors to complete a Master's degree in agricultural education before entering the secondary classroom. This advanced degree will give students more time to hone their teaching skills and prepare for the cadre of experiences they will face as a new teacher. One may argue that this additional time at the university will boost their self-efficacy and lower the attrition rate among new and/or beginning teachers.

References

- Ashton & Webb (1986). *Making a Difference: Teacher Efficacy and Student Achievement*. Monogram. White Plains, NY: Longman.
- Bandura, A. (1977). *Self Efficacy: Toward a unifying theory of behavioral change*. *Psychological Review*. 84, 191-215.
- Bandura, A. (1986) *Social foundations of thought and action: A social cognitive theory*. Englewood Cliffs, NJ: Prentice Hall.
- Bandura, A. (1994). Self-efficacy. In V.S. Ramachaudran (Ed.), *Encyclopedia of human*

- behavior* (Vol. 4, pp. 71-81). New York: Academic Press. (Reprinted in H. Friedman [Ed.], *Encyclopedia of mental health*. San Diego, CA: Academic Press, 1998).
- Bandura, A. (1997). *Self-efficacy: The exercise of control*. New York, NY:Freeman.
- Bandura, A. (2004). Swimming against the mainstream: The early years from chilly tributary to transformative mainstream. *Behavior Research and Therapy*, 42, 613-630.
- Bandura, A. (2006). Guide for constructing self-efficacy scales. In F. Pajares & T. Urdan (Eds.). *Self-Efficacy Beliefs of Adolescents*, (Vol. 5., 307-337.). Greenwich, CT: Information Age Publishing.
- Croom, D. B. (2003). Teacher burnout in agricultural education. *Journal of Agricultural Education*, 44(2), 1-13.
- Darling-Hammond, L., & Bransford, J. (Eds.). (2005). *Preparing teachers for a changing world: What teachers should learn and be able to do*. San Francisco: Jossey-Bass.
- Davis, J. A. (1971). *Elementary survey analysis*. Englewood, NJ: Prentice Hall.
- Duncan, D., & Ricketts, J. C. (2006). Total program efficacy: A comparison of traditionally and alternatively certified agriculture teachers. *Proceedings of the Southern Region American Association for Agricultural Education Conference, Orlando, FL*, 409-419.
- Duncan, D., Ricketts, J. C., Peake, J. B., & Uessler, J. (2005). Identifying teaching and learning in-service need of Georgia Agriculture teachers. *Proceedings of the National Agricultural Education Research Conference, San Antonio, TX*, 31, 91-102.
- Garton, B. L., & Chung, N. (1996). The in-service needs of beginning teachers of agriculture as perceived by beginning teachers, teacher educators, and state supervisors. *Journal of Agricultural Education*, 37(3), 52-58.
- Georgia FFA. Retrieved August 30, 2009 from <http://www.georgiaffa.org>
- Hurley, D., & Thorp, J. (Eds.) (2002). *Decisions without direction: Career guidance and decision making among American youth*. Ferris State University Career Institute for Education and Workforce Development. Retrieved June 13, 2008 from <http://www.ferris.edu/CAREERINSTITUTE/research.htm>
- Ingersoll, R. M. (2001). Teacher turnover and teacher shortages: An organizational analysis. *American Educational Research Journal*, 38, 499-534.
- Joerger, R.M. (2002). A comparison of the inservice education needs of two cohorts of

- beginning Minnesota agricultural education teachers. *Journal of Agricultural Education*, 43(3), 11-24.
- Kantrovich, A. J. (2007, May). *A national study of the supply and demand for teachers of agricultural education from 2004-2006*. American Association for Agricultural Education. Retrieved June 19, 2007, from <http://aaae.okstate.edu/>.
- Kotrlik, J. W., & Harrison, B. C. (1987). Factors related to the career decisions of seniors who have taken vocational agriculture [Electronic version]. *Journal of the American Association of Teacher Educators in Agriculture*, 28, 50-56.
- Krumboltz, J. D. (1976). A social learning theory of career choice. *Counseling Psychologist*, 6, 71-80.
- Lent, R.W., Brown, S.D., & Hackett, G. (1994). Monograph: Towards a unifying social cognitive theory of career and academic interest, choice, and performance. *Journal of Vocational Behavior*, 45, 49-122.
- Mundt, J. P., & Connors, J. J. (1999). Problems and challenges associated with the first years of teaching agriculture: A framework for preservice and inservice education. *Journal of Agricultural Education*, 40(1), 38-48.
- Myers, B. E., Dyer, J. E., & Washburn, S. G. (2005). Problems facing beginning agriculture teachers. *Journal of Agricultural Education*, 46(3), 47-55.
- Niles, S.G., & Harris-Bowlsbey, J. (2005). *Career development interventions in the 21st century*. (2nd ed.). Saddle River, NJ: Pearson Education, Inc.
- Osborne, E., & Dyer, J. (2000). Attitudes of Illinois agriscience students and their parents toward agriculture and agricultural education programs. *Journal of Agricultural Education*, 41(3), Retrieved from <http://pubs.aged.tamu.edu/jae/pdf/Vol41/41-03-50.pdf>
- Park T, & Rudd, R. (2005). A Description of the characteristics attributed to students' decisions to teach agriscience. *Journal of Agricultural Education*, 46(3).
- Priest, K, (2008). *The influence of learning activities on the career decision self-efficacy of high school seniors in agricultural education* (Masters thesis), University of Georgia, Athens, GA.
- Roberts, T. G., & Dyer, J. E. (2004). Characteristics of effective agriculture teachers. *Journal of Agricultural Education*, 45(4), 82-95.
- Talbert, B.A., & Balschweid, M.A. (2004) Engaging students in the agricultural education model: Factors affecting student participation in the National FFA Organization. *Journal of Agricultural Education*, 45, 29-41.
- Talbert, B. A., Camp, W. G., & Heath-Camp, B. (1994). A year in the lives of three

- beginning agriculture teachers. *Journal of Agricultural Education*, 35(2), 31-36.
- Team AgEd. (2007). 2005-2006 Annual Report on Agricultural Education.
- Tschannen-Moran, M., & Woolfolk Hoy, A. (2001). Teacher efficacy: capturing an elusive construct. *Teaching and Teacher Education*, 17, 783-805.
- Vroom, V, 1964. *Work and Motivation*. New York, NY: Wiley.
- Wolf, K, & Miller, L. (2008). Agricultural education teacher self-efficacy: a descriptive study of beginning agricultural education teachers in Ohio. Retrieved from http://etd.ohiolink.edu/send-pdf.cgi/Wolf%20Kattlyn%20Jean.pdf?acc_num=osu1216999467
- Woolfolk, A. E. (2000, April). Changes in teacher efficacy during the early years of teaching. *Paper presented at the annual meeting of the American Educational Research Association, New Orleans, L.A.*

Stress Levels of Agricultural Science Student Teachers and Cooperating Teachers

*Billy R. McKim, John Rayfield, Julie Harlin, Andrew Adams, Bart E. Gill,
Texas A&M University*

Abstract

The purpose of this study was to compare the job stress levels of [State] agricultural science cooperating teachers and [State] agricultural science student teachers. The research objectives included: describing secondary agricultural science cooperating teachers and student teachers perceptions of stressors, by time of semester (beginning, middle, and end), describing perceptions of frequency of stressors, by time of semester (early semester, mid semester, late semester) among secondary agricultural science cooperating teachers and student teachers, and determining if differences exist between agricultural science student teachers' and cooperating teachers' based on perceptions of job stress and time of semester (early semester, mid semester, late semester). Job stress severity declined among student teachers as the semester progressed and increased in cooperating teachers at the midpoint of the semester, but then declined toward the end of the semester. Job stress frequency increased in student teachers throughout the semester and declined in cooperating teachers at mid-semester with a slight increase at the end of the semester. Job pressure index scores showed similar trends with an increase throughout the student teaching semester.

Introduction / Review of Literature

According to the American Institute of Stress, there is not a widely accepted definition for the term stress. Stress is a term that holds a different meaning for different researchers across disciplines; the term can refer to various situations. For the purpose of this study, stress will be defined as “a condition or feeling experienced when a person perceives that demands exceed the personal and social resources the individual is able to mobilize” and/or “...physical, mental, or emotional strain or tension” (<http://www.stress.org>).

The causes and consequences of stress are different for each individual person. A multitude of researchers have conducted studies to examine stress inflicted by culture (Warren-Findlow, 2010), relationships (Maguire, 2010), family (Diamond, 1991), parenting (Bronte-Tinkew, Horowitz, & Carrano, 2010), major events (e.g. Post-Traumatic Stress disorder) (Katz, 2002), health problems (Pederson & Zachariae, 2010), school (Ratanasiripong, Sverduk, Hayashino, & Prince, 2010), work (Vagg & Spielberger, 1998), etc. Though the consequences of stress are based on each individual, the response to stress is nearly the same in all people. The responses to stress can be physical, physiological, or emotional and have effects on efficiency and productivity.

It is common knowledge that teachers have a rather challenging job and in many cases teaching can be a stressful profession. The majority of teachers agree that their jobs are rewarding. It is a challenging career because of too few resources, too much paperwork, crowded classrooms, students with emotional problems, low pay, and high-stakes standardized testing (Strauss, 2002). According to Humphrey and Humphrey (1986) 23% of teachers believe that they have a poor ability to cope with stress. They also estimated that teachers make more

than 400 decisions in day. The researchers reported that 35% of teachers call in sick due to fatigue, averaging four-and-one-half days of absences each year with one-third of those absences directly related to stress.

Peirce and Molloy (1990) compared teachers in a low-burnout group to teachers in a high-burnout group. The teachers experiencing high-burnout were less satisfied with their career, absent from work more frequently, had poorer physical health, and had less career commitment. The researchers also reported that teachers with high burnout perceived less social support in their individual school environments than those teachers in the low-burnout group. This supports Laughlin's (1984) discovery that teacher's perceptions of stress were decreased by support from special friends and colleagues on their school staff, also poor physical health was reduced by colleague support. An additional study conducted by Greenglass, Burke, and Konarski (1997) indicated that social support, particularly from co-workers, contributed to the prediction of burnout. High levels of social support predicted decreased depersonalization and an increased feeling of accomplishment. These findings supported the research done by Himle, Jayaratne, and Thyness (1991) that discovered information and instrumental support from co-workers buffered burnout components that were related to stress induced by role conflict and work overload. These studies imply that teachers who work in an environment that is perceived as being supportive are less likely to suffer the high level of burnout.

The profession of secondary agricultural education teacher is a rewarding and time-consuming career. However, some secondary agricultural science teachers find themselves working more than 40 + hours per week. They are responsible for supervising student projects, training career development event teams, preparing lessons, and evaluating their students (Straquadine, 1990). Secondary agricultural education teachers have deadlines to meet for grading, livestock entries, developing lesson plans, and the list could go on. Teacher education programs do their best to prepare beginning agricultural education teachers for their profession. One area they do not place a large emphasis on is preparing their new teachers to handle the stress that comes with the job. Teacher preparation programs should prepare students to recognize stress factors and to employ effective coping mechanisms (Rieg, Paquette, & Chen, 2007).

Delnero and Montgomery (2001) reviewed the known literature and found that the phenomenon of increasing job responsibilities in agricultural education is well documented. Torres, Lawver, and Lambert (2008) established the idea that recognizing the variety of roles and responsibilities that secondary agricultural teachers have, is important in understanding their stress. A study conducted by the National Research Council (1988) found that secondary agricultural teachers often spend a great deal of time "helping students excel in traditional production oriented FFA contests and award programs" (p. 43) and less time on face-to-face classroom instruction.

Student teachers face the same challenges and stressors as cooperating teachers, plus they have their own set of stress factors. Causes of stress for student teachers include, but are not limited to, lack of experience, conflict between advice and expectations, unclear perceptions of own status, and lack of strategies for coping with emergent situations (Rieg, Paquette & Chen, 2007). The American Psychological Association (www.apa.org) reported that new teachers face new challenges every day. These challenges include managing a classroom, and planning and

teaching lessons for the first time every day during the first year. Teachers also have to work with the individual issues each child brings to the classroom, concern about evaluation by the school administration, fitting in with new colleagues, and working with parents, all of which can lead to elevated levels of stress for a teacher. An experienced teacher will have been through their first year experience and gained knowledge of these stressors and how to handle them when they arise.

Other researchers have investigated the relationship between student teachers and cooperating teachers. Kitchel and Torres (2007) state a common theme throughout research related to student teachers in agricultural education is that cooperating teachers are important. Harlin, Edwards, and Briers (2002) reported that student teachers rated their relationship with their cooperating teacher as the most important student teaching element. This knowledge brings to mind a question that must be answered; how stressed are agricultural science teachers and is there a difference between cooperating teachers and student teachers across the semester?

Conceptual Framework

The Job Stress Survey (JSS) was created out of necessity. Other measures of job stress failed to either address perceived severity of stressors or confused the severity of stressors with the frequency of the occurrence of stressors (Vagg & Spielberger, 1998). The basic construct for the JSS came from the notion that “ideally, job stress measures should evaluate both the perceived severity of specific sources of stress in the workplace and how often each work-related stressor is experienced by the respondent during a specified period of time”(Vagg & Spielberger, 1998, p. 298). Frequency and severity measurement is significant, because although some events may cause participants to sense a severe amount of stress, those events may rarely or even never occur, therefore reducing their overall impact (Vagg & Spielberger, 1998).

Spielberger, Reheiser, Reheiser, and Vagg (1999) developed the current JSS based on the Police Stress Survey (PSS) and the Teacher Stress Survey (TSS). Thirty of the 39 items found to be mutually applicable between the PSS and TSS were applied to the development of the JSS. Since the creation of the JSS, the questionnaire has been adapted and used in a multitude of diverse disciplines. Spielberger and Reheiser (1994) administered the JSS to 2,389 adults employed in university, corporate, and military settings. Torres, Lambert, and Lawver (2009) used the JSS to study secondary agriculture science teachers and they found that although, overall the teachers were not in a state of stress, the teachers were very close to being in a “...state of stress...” They also found that one-third of the teachers did experience elevated levels of stress (Torres, et al., 2009).

Purpose and Research Questions

The purpose of this study was to examine stress levels of agricultural science student teachers and their cooperating teachers throughout the semester. The following research questions were used to guide the study.

1. What are agricultural science student teachers' and cooperating teachers' perceptions of stressors, by time of semester (beginning, middle, and end)?

2. What are agricultural science student teachers' and cooperating teachers' perceptions of frequency of stressors, by time of semester (early semester, mid semester, late semester)?
3. Do differences exist between agricultural science student teachers' and cooperating teachers' based on perceptions of job stress and time of semester (early semester, mid semester, late semester)?

Procedures

The target populations for this study were secondary agricultural science teachers and agricultural science student teachers during the spring 2010 field practicum, as part of the teacher education program at [a Land Grant University] in [a southern state]. A total of 27 student teachers enrolled in the student teaching field practicum and their cooperating teachers ($n = 61$) were invited to participate.

The data collection instrument used in this study was the Job Stress Survey (JSS), developed by Spielberger and Vagg in 1999. The questionnaire consisted of three sections: the first section of the questionnaire sought to measure each subject's perceived severity of 30 stressful work-related events on a 1 to 9 summated rating scale; the first item, "assignment of disagreeable duties," was listed in the instrument's instructions as an example of an item that produces an average amount of stress or a 5 on the 9-point scale. Therefore, subjects were asked to respond to the 29 remaining items in the first section based on the first example. The second section sought to measure the subjects' perceived frequency of the same 30 items presented in the first section, on a 0 to 9 scale of frequency of occurrence. The third section sought to determine the subjects' age and gender.

The JSS (Spielberger & Vagg, 1999) served as the basis for the multi-mode data collection instrument developed for this study. The design and format of both modes of the data collection instrument were guided by Dillman, Smyth, and Christian (2009). Both modes of questionnaires were near identical in format; however, the logistics of distributing and collecting a paper questionnaire to each of the cooperating teachers, via mail in the same timeframe as the student teachers did not seem reasonable, when considering the additional time needed to follow up for nonresponse. Therefore, the researchers closely followed Dillman et al.'s recommendations for mixed mode data collection.

Face validity was determined by a panel of eight experts, all of whom are considered experts in the areas of agricultural education, instrument development, and research methodology. Each expert was provided a paper copy of the instrument and e-mailed a link to the Web-based electronic instrument. Experts were asked to determine if the questionnaires "...appeared valid for [their] intended purpose" (Ary, Jacobs, Razavieh, & Sorensen, 2006, p. 439) and if they had any concern that respondents may respond differently, based upon the mode of the questionnaire.

Content validity of the data collection instrument was determined by the previously noted panel of experts. Each of the experts assessed the "...appropriateness and representativeness of the items..." on the questionnaire (Ary, et al., 2006, p. 256). Experts were asked to pay close attention to the wording of the questions to ensure that each question would make sense to the

intended population. Several revisions to wording or examples were made based on the feedback from the expert panel; however, the researchers did not believe any of the changes were substantial enough to change the original intent of the question.

Construct validity was assessed in several previous studies through exploratory and confirmatory factor analyses (see Spielberger & Vagg, 1999). Development of constructs and testing of JSS were previously outlined and resulted in the commercial JSS data collection instrument published by Psychological Assessment Resources, Inc. in 1999. Because the items used in this study were based upon the items and constructs previously determined to be valid, the constructs were considered valid.

Reliability was determined by conducting a pilot test for each mode of the data collection instrument (paper and web-based electronic) using the same three-round data collection method used in this study. Reliability for the student teacher instrument was determined by conducting a pilot test using individuals with similar characteristics of the student teachers in the sample population; in this case the 17 student teachers during the fall semester 2009. After three rounds of data collection, using the paper data collection instrument, a total of 44 useable responses were collected. Reliability for the cooperating teacher instrument was determined by conducting a pilot test using individuals with similar characteristics of the cooperating teachers in the sample population; in this case the 28 cooperating teachers during the fall semester 2009. After three rounds of data collection, using the web-based electronic data collection instrument, a total of 67 useable responses were collected. Cronbach's alpha coefficients were calculated for the JS-S, JS-F, and JS-X scales for the paper and web-based electronic questionnaires, which ranged from .90 to .97. Using the data collected for this study, *post hoc* Cronbach's alpha coefficients were calculated for the JS-S, JS-F, and JS-X scales of each round, which yielded coefficients ranging from .93 to .95.

Data Collection

Dillman et al. (2009) served as the primary guidance for data collection for this study. Data collection for student teachers and cooperating teachers was conducted using the same instrument, but through different modes: student teacher data were collected via a researcher-administered paper questionnaire; cooperating teacher data were collected via a Web-based electronic questionnaire. Data were collected at three points during the spring semester in 2010: round 1, the first two weeks of February; round 2, the last week of March and first week in April; and round 3, the second and third weeks in May.

Student teacher data were collected the week before student teachers began their student teaching field practicum (early semester); during their mid semester conference (mid semester), on-campus; and immediately following their student teaching field practicum, upon returning to campus (late semester). Because all student teachers ($n = 27$) participated in three rounds of data collection—one student teacher did not complete the third-round questionnaire—no follow up measures were taken to account for nonresponse error.

Personalized e-mail invitations were sent to cooperating teachers for each round of data collection. Each invitation explained the purpose of the study, explained that they would be asked to participate three times during the semester, and included a link to the Web-based

electronic questionnaire. To maximize response rate, up to three invitations were sent to each cooperating teacher, for each round of data collection. As electronic questionnaires were completed during each round, the names of the individuals who had responded were removed from the correspondence list of cooperating teachers. Response rates for each round are summarized in Table 1. Although response rates, in some cases, were greater than indicated in Table 1, only complete and useable responses are indicated.

Table 1
Summary of Response Rates for Each Round of Data Collection

	Round 1		Round 2		Round 3	
	<i>n</i>	%	<i>n</i>		<i>n</i>	
Student Teacher	27	100.0	27	100.0	26	96.3
Cooperating Teacher	46	75.4	38	62.3	42	68.9

Nonresponse error was a relevant concern for cooperating teacher data; therefore, procedures for handling response bias were followed as outlined as *Method 1* in Lindner, Murphy, and Briers (2001). The relatively small number of respondents for each round did not allow for a parametrically-amenable, dichotomous grouping of at least 30 respondents. Therefore, nonparametric comparisons were made between early and late respondents using the Mann–Whitney *U* test to compare the scale variables of interest, JS-S, JS-F, and JS-X, which served as the dependent variables for each round. Dichotomously-split early and late respondent groups (Miller & Smith, 1983) served as the independent variable for each round. Mann-Whitney *U* tests yielded no significant differences ($p < .05$) between early and late respondent data (see Table 2); therefore, external validity did not threaten the generalizability of the findings of this study to the target population (Lindner, et al., 2001; Radhakrishna & Doamekpor, 2008).

Table 2
Comparison of Early to Late using Mann-Whitney U Test

Scale	<i>U</i>	<i>z</i>	<i>Mdn</i>		<i>p</i>
			<i>Early</i>	<i>Late</i>	
Round 1 – Early ($n = 23$) to Late ($n = 23$)					
JS-S	288.5	-0.67	4.77	4.97	.503
JS-F	255.5	-0.19	3.75	3.62	.852
JS-X	244.0	-0.44	0.63	0.66	.660
Round 2 – Early ($n = 19$) to Late ($n = 19$)					
JS-S	216.0	-1.03	5.00	4.93	.305
JS-F	124.0	-1.54	3.97	2.97	.124
JS-X	140.0	-1.06	0.63	0.49	.287
Round 3 – Early ($n = 21$) to Late ($n = 21$)					
JS-S	233.5	-0.44	4.53	4.87	.658
JS-F	198.5	-0.55	3.93	3.53	.580
JS-X	204.0	-0.42	0.61	0.49	.678

Data Analysis

Data were analyzed using SPSS® version 17.0 for Windows™ platform computers. The purpose of research question one was to describe agricultural science student teachers' and cooperating teachers' perceptions of stressors by time of semester. The mean and standard deviation for each of the three rounds (early semester, mid semester, and late semester) are indicated in Table 3 for the items associated with the Job Stress Severity (JS-S) Scale. Stressor items are reported in the order presented in the data collection instrument. The JS-S scale is purported to be an indicator of respondents' average rating of *perceived severity* of the 30 stressor items. The first item, "assignment of disagreeable duties," is not reported for the JS-S scale, because respondents are informed that assignment of disagreeable duties typically elicits a 5 on the 9-point scale; thus, respondents are asked to use that as a standard basis for comparison for their other responses.

The purpose of research question two was to describe agricultural science student teachers' and cooperating teachers' perceptions of frequency of stressors by time of semester. The mean and standard deviation for each of the three rounds (early semester, mid semester, and late semester) are indicated in Table 3 for the 30 items associated with the Job Pressure Frequency (JS-F) Scale. The JS-F scale is purported to be an indicator of the *average frequency of occurrence* of the 30 stressor items in the six months preceding the individual measurement.

The purpose of research question three was to determine if differences existed between agricultural science student teachers and cooperating teachers, based on perceptions of job stress and time of semester (early semester, mid semester, and late semester). The JS-X scale was purported to be an estimate of the *overall level of occupational stress* experienced by respondents; therefore it was used as a summary measure of the previous scales.

Field's (2009) outline of methods for analyses and interpretation of the data served as the primary guidance for the multivariate analyses. Tabachnick and Fidell (2007) served as a secondary source of guidance. A multivariate analysis of variance (MANOVA) was used to compare the variables of interest. A MANOVA is the appropriate analysis when "multiple independent and/or dependent variables and the measured variables are likely to be dependent on each other (i.e., to correlate)... Thus, multivariate analysis allows for the examination of two variables while simultaneously controlling for the influence of the other variables on each of them" (Newton & Rudestam, 1999, p. 137).

A MANOVA was conducted using JS-X scores as the dependent variables, and using academic position—student teacher or cooperating teacher—as the independent variable. Because of the longitudinal nature of these analyses, only the responses of those individuals who responded to all three rounds of data collection were analyzed; agricultural science student teachers ($n = 25$) and cooperating teachers ($n = 25$). The alpha level was set *a priori* at .05. Degrees of freedom, F ratio, p -value, effect size (η_p^2), and power ($1 - \beta$) were reported for each analysis. Effect sizes were interpreted according to Tabachnick and Fidell (2007) who noted MANOVA guidelines for small ($\eta_p^2 = .10$), medium ($\eta_p^2 = .25$), and large ($\eta_p^2 = .40$) effects.

Findings

A summary of job stress severity (JS-S), job stress frequency (JS-F) and job pressure index scores (JS-X) are summarized in Table 3, by scale and by round of measure. A summary of self-perceived stress levels of student teachers and cooperating teachers is presented in Table 4.

Table 3

Summary of Job Stress Severity, Job Stress Frequency, and Job Pressure Index Scores

	Round 1		Round 2		Round 3	
	<i>M</i>	<i>SD</i>	<i>M</i>	<i>SD</i>	<i>M</i>	<i>SD</i>
JS-S						
Student Teacher	5.00	1.12	3.62	1.47	3.79	1.30
Cooperating Teacher	4.67	1.23	4.85	1.18	4.60	1.26
JS-F						
Student Teacher	0.90	1.13	3.00	1.75	3.44	1.51
Cooperating Teacher	3.74	1.28	3.45	1.46	3.67	1.45
JS-X						
Student Teacher	5.00	6.67	12.73	12.03	14.06	11.02
Cooperating Teacher	18.44	8.00	16.77	8.68	18.12	11.22

Note: Round 1 = Early Semester, Round 2 = Mid Semester, Round 3 = Late Semester; Student Teachers = Round 1 ($n = 27$), Round 2 ($n = 27$), Round 3 ($n = 26$); Cooperating Teachers = Round 1 ($n = 46$), Round 2 ($n = 38$), Round 3 ($n = 42$).

Table 4

Summary of Stress Levels of Student Teachers and Cooperating Teachers, Based on JS-X Scores Across a Spring Semester

	<i>n</i>	Round 1		Round 2		Round 3	
		<i>M</i>	<i>SD</i>	<i>M</i>	<i>SD</i>	<i>M</i>	<i>SD</i>
Student Teacher	25	4.78	6.75	13.21	12.39	14.34	11.15
Cooperating Teacher	25	17.52	7.89	16.42	7.81	16.42	9.07

Note: Round 1 = Early Semester, Round 2 = Mid Semester, Round 3 = Late Semester.

The purpose of research 3 was to determine if differences existed between agricultural science student teachers' and cooperating teachers' based on perceptions of job stress and time of semester (beginning, middle, and end). Hence, stress levels of agricultural science student teachers and cooperating teachers, based on JS-X scores, served as the dependent variables; academic position, i.e. student teacher or cooperating teacher, served as the independent variable. The alpha level was set *a priori* at .05. The results of the MANOVA were interpreted using Wilks' lambda (λ). Significant differences existed between the stress levels of agricultural science student teachers and cooperating teachers, based on JS-X scores $\lambda = .70$, $F(2, 47) = 9.92$, $p < .001$, $\eta_p^2 = .297$, indicating a medium effect size. Additionally, the observed power ($1 - \beta = .978$) met the minimum power cut-off of 0.80, meaning that significant differences did not exist due to chance or error.

Univariate ANOVAs were conducted as follow-up procedures to the significant MANOVA. Results revealed that differences existed between agricultural science student

teachers and cooperating teachers $F(1, 48) = 7.29, p = .010, \eta_p^2 = .132, 1 - \beta = .753$. *Post hoc* tests were not necessary for differences between agricultural science student teachers and cooperating teachers, because only two groups were included in the analysis. Mauchly's test of sphericity was not violated ($p = .277$); therefore, p -value interpretations for within-subjects were made based on sphericity assumed. Significant linear differences existed between rounds of data collection, i.e. time of semester (beginning, middle, and end), $F(1, 48) = 12.24, p = .001, \eta_p^2 = .203, 1 - \beta = .929$. The partial eta squared score ($\eta_p^2 = .203$) indicated a small effect size. Planned contrasts revealed that all three measurements were significantly different from one another ($p = < .05$).

Conclusions, Recommendations, Implications

This study addresses the Agricultural Education in Schools research priority area focusing on RPA 4: Prepare and provide an abundance of fully qualified and highly motivated agricultural educator at all levels. The research study addresses this research priority area by addressing the stress levels and stressors experienced by both student teachers and cooperating teachers during the field practicum.

Three rounds of data were collected from 27 student teachers and more than 40 cooperating teachers in the spring semester of 2010. Job stress severity declined among student teachers as the semester progressed. Job stress severity increased in cooperating teachers at the midpoint of the semester, but then declined toward the end of the semester. Job stress frequency increased in student teachers throughout the semester and declined in cooperating teachers at mid-semester with a slight increase at the end of the semester. Job pressure index scores showed similar trends with an increase throughout the student teaching semester. Cooperating teachers showed a decrease in job pressure index at mid semester followed by a slight increase at the end of the semester. These findings support Torres et al.'s (2009) findings that secondary agricultural science teachers experienced elevated levels of stress. However, the question arises, are stressors constant with secondary agricultural science teachers across the school year? Future research efforts should focus on the more stressful times during a school year.

Stress levels of student teachers and cooperating teachers were significantly different, with a medium effect size. Stress levels were also significantly different between measurements, across the semester, with a small effect size. Therefore, student teachers' and cooperating teachers' stress levels were not only different when observed holistically (student teachers vs. cooperating teachers), but student teachers' and cooperating teachers' stress levels were also different at each point of data collection across the semester (beginning, middle, and end). This implies that even though the student teachers' and cooperating teachers' job responsibilities are similar, there are different factors throughout the semester that are affecting student teacher stress levels, when compared to the factors that are affecting cooperating teacher stress levels. Many previous studies have investigated characteristics, perceptions, and numerous influential factors of student teachers and in-service agriculture teachers. These studies have mainly investigated the relationship between cooperating teachers and the student teacher whom they mentor during their field practicum. Very few, if any, studies have investigated the influences of one on the other; e.g. the effects of a student teacher on their cooperating teacher. Given that the results of this study indicate that differences exist between student teachers' and cooperating teachers' stress levels and that this study is among the first to investigate stress levels of student

teachers, there is need for further investigation whether student teachers affect the stress level of their cooperating teacher during their field practicum.

Furthermore, knowing that there is a difference between the stress levels of student teachers and cooperating teachers, additional inquiry is necessary to determine if specific indices of stress, e.g. lack of support and job pressure (see Torres et al., 2009), affect student teachers and in-service agriculture teachers in the same manner. Additionally, the differing levels of stress across a semester (three longitudinal measurements) investigated in this study, would suggest that further investigation is necessary to determine if stress levels of student teachers and in-service agriculture teachers differ not only across semesters, but between semesters.

References

- Ary, D., Jacobs, L. C., Razavieh, A., & Sorensen, C. (2006). *Introduction to research in education* (7th ed.): Thomson Wadsworth.
- Bronte-Tinkew, J., Horowitz, A., & Carrano, J. (2010). Aggravation and stress in parenting: associations with coparenting and father engagement among resident fathers. *Journal of Family Issues, 31*(4), 525-555.
- Delnero, J., & Montgomery, D. (2001). Perceptions of work among California agriculture teachers. *Journal of Agriculture Education, 42*(2), 56-67. DOI: 10.5032/jae.2001.02056
- Diamond, D. B. (1991). All stressed out. *Ladies' Home Journal, 108* (November 1991).
- Dillman, D. A., Smyth, J. D., & Christian, L. M. (2009). *Internet, mail, and mixed-mode surveys: The tailored design method* (3rd ed.). Hoboken, NJ: Wiley and Sons.
- Field, A. (2009). *Discovering statistics using SPSS* (3rd ed.). Thousand Oaks, CA: SAGE Publications Ltd.
- Greenglass, E. R., Burke, R. J., & Konarski, R. (1997). The impact of social support on the development of burnout in teachers: examination of a model. *Work & Stress, 11*(3), 267-278.
- Harlin, J. F., Edwards, M. C., & Briers, G. E. (2002). A comparison of student teachers' perceptions of important elements of the students teaching experience before and after an 11-week field experience. *Journal of Agricultural Education, 43*(3), 72-83. DOI: 10.5032/jae.2002.03072.
- Himle, D. P., Jayaratne, S., & Thyness, P. (1991). Buffering effects of four social support types on burnout among social workers. *Social Work and Research and Abstracts, 27*, 22-27.
- Humphrey, J. N., & Humphrey, J. H. (1986). *Coping with stress in teaching*. New York, NY: AMS Press, Inc.

- Katz, C. L. (2002). Research on psychiatric outcomes and interventions subsequent to disasters: a review of the literature. *Psychiatry Research, 110*(3), 201-217.
- Kitchel, T. & Torres, R. M. (2007). Possible factors in matching student teachers with cooperating teachers. *Journal of Agricultural Education, 48*(3), 13-24. DOI: 10.5032/jae.2007.03013.
- Laughlin, A. (1984). Teacher stress in an Australian setting: the role of biographical mediators. *Educational Studies, 10*, 7-22.
- Lindner, J. R., Murphy, T. H., & Briers, G. E. (2001). Handling nonresponse error in social science research. *Journal of Agricultural Education, 42*(4), 43-53. DOI: 10.5032/jae.2001.04043
- Maguire, K. (2010). When distance is problematic: communication, coping, and relational satisfaction in female college students' long-distance dating relationship. *Journal of Applied Communication Research, 38*(1), 27-46.
- Miller, L. E., & Smith, K. L. (1983). Handling nonresponse issues. *Journal of Extension, 21*(5), 43-50.
- National Research Council. (1988). *Understanding agriculture: New directions for education*. Washington, DC: National Academy Press.
- Newton, R. R., & Rudestam, K. E. (1999). *Your Statistical Consultant*. Thousand Oaks, CA: Sage.
- Pederson, A. F., & Zachariae, R. (2010). Cancer, acute stress disorder, and repressive coping. *Scandinavian Journal of Psychology, 5*(1), 84-91.
- Pierce, C. M., & Molloy, G. M. (1990). Psychological and biographical differences between secondary school teachers experiencing high and low levels of burnout. *British Journal of Educational Psychology, 60*, 37-51.
- Radhakrishna, R., & Doamekpor, P. (2008). Strategies for Generalizing Findings in Survey Research. *Journal of Extension, 46*(2), Retrieved from <http://www.joe.org/joe/2008april/tt2001.php>.
- Ratanasiripong, P., Sverduk, K., Hayashino, D., & Prince, J. (2010). Setting up the next generation biofeedback program for stress and anxiety management for college students: a simple and cost-effective approach. *College Student Journal, 44*(1), 97-100.
- Rieg, S. A., Paquette, K. R., & Chen, Y. (2007). Coping with stress: An investigation of novice teachers' stressors in the elementary classroom. *Education, 128*(2), 211-226.
- Spielberger, C. D., & Reheiser, E. C. (1994). Job stress in university, corporate, and military personnel. *International Journal of Stress Management, 1*(1).

- Spielberger, C. D., Reheiser, E. C., Reheiser, J. E., & Vagg, P. R. (1999). Measuring stress in the workplace: The Job Stress Survey. In Kenny, D., Carlson, J., McGugan, F., & Sheppard, J. (Eds.), *Stress and health: Research and clinical applications*. Ryde, Australia: Gordon & Breach, Science Publisher/Harwood Academic Publishers.
- Spielberger, C. D., & Vagg, P. R. (1999). *Job Stress Survey*. Lutz, FL: Psychological Assessment Resources, Inc.
- Straquadine, G. S. (1990, June). Work, is it your drug of choice? *The Agricultural Education Magazine*, 62(12), 11-12.
- Strauss, V. (2002). *Everyday problems*. Retrieved May 25, 2010, from <http://www.washingtonpost.com/wp-dyn/articles/A61601-2002Oct21.html>
- Tabachnick, B. G., & Fidell, L. S. (2007). *Using Multivariate Statistics* (5th ed.). Boston, MA: Pearson.
- Torres, R. M., Lambert, M. D., & Lawver, R. G. (2009). *Job stress among secondary agriculture teachers: An explanatory study*. Paper presented at the American Association for Agricultural Education Research Conference, Louisville, KY.
- Torres, R. M., Lawver, R. G., & Lambert, M. D. (2008). *Job stress among secondary agriculture teachers: highs and lows*. Paper presented at the North Central American Association for Agricultural Education, Ithica, NY.
- Vagg, P. R., & Spielberger, C. D. (1998). Occupational stress: measuring job pressure and organizational support in the workplace. *Journal of Occupational Health Psychology*, 3(4), 294-305.
- Warren-Findlow, J. (2010). Stress and coping in African American women with chronic heart disease: a cultural cognitive coping model. *Journal of Transcultural Nursing*, 21(1), 45-54.

The Relationship between Cooperating Teachers' Leadership Style and Student Teachers' Satisfaction Level

Gaea Wimmer, Dr. Todd Brashears, Dr. Scott Burri; Texas Tech University

Abstract

The purposes of this study were to describe characteristics of the student teachers, their level of satisfaction with their cooperating teaching, the cooperating teachers preferred leadership style and the relationship between the cooperating teacher's leadership style and the student teacher's level of satisfaction. Twenty-nine cooperating teachers (63%) completed the ELSI-AG and nineteen student teachers completed an instrument designed to measure satisfaction (100%). The ELSI-AG posed 20 scenarios for the cooperating teacher to read and then select the option they would use from a list of four. Based on the number of responses chosen, the cooperating teacher was identified as preferring either directing, coaching, supporting, or delegating leadership style based on Hersey & Blanchard's Situational Leadership Theory. The majority of cooperating teachers preferred the supporting leadership style (n = 21). The student teachers completed a satisfaction instrument based on the work of Greiman (2002) and Kitchel (2005). There were three main components to the instrument: psychosocial functions, disconfirmation, and perceived satisfaction. Correlations were calculated to determine the magnitude of relationships between preferred leadership style of the cooperating teacher and student teacher satisfaction.

Introduction

There is a need for highly qualified teachers in every area of education in the United States. There are over 150,000 public school teachers hired every year to fill the vacancies (Hussar, 1998). The estimated number of teachers needed from 1998 to 2009 was 1.7 to 2.7 million (Hussar, 1998). New teachers are needed to replace those leaving for other jobs, retirement, and increasing student enrollment. This leaves schools with the difficult task of replacing experienced teachers. President Obama is aware of the need for teachers and addressed it in his remarks on education, "America's future depends on its teachers." He encouraged more people to consider becoming a teacher to make a difference in the lives of youth. "America needs you. We need you in classrooms all across our country" ("Obama's Remarks on Education", 2010, para. 21).

Agricultural education suffers from similar issues in the profession is experiencing a shortage of qualified new teachers each year seeking to enter teaching. The *Research Agenda for Agricultural Education & Communications* recognizes this need with the research priority area of "preparing and providing an abundance of fully qualified and highly motivated agriscience educators" (Osborne, n.d., p. 20). While agricultural education continues to graduate enough students to fill the need, almost half are choosing to not enter the teaching profession (Kantovich, 2007). The persistent loss of prospective teachers will continue to create shortages in the field. In addition to graduating students choosing to seek employment in other industries, the profession continues to see a loss of teachers before their sixth year of experience (Marso & Pigge, 1997). While it is imperative researchers continue to determine causes of attrition in beginning teachers, it is also important to begin developing interventions designed to slow the exodus of teachers from the field.

The student teaching semester is very important in determining the success of the student and impacts their decision to enter the profession (Deeds, Flowers, & Arrington, 1991; Grimmett &

Ratlaff, 1986; Norris, Larke, & Briers, 1990; Schumacher & Johnson, 1990; Schuman, 1969). Past studies recognize the importance of the relationship between the cooperating teacher and the student teacher. (Barnes & Camp, 2002; Deeds, 1993; Deeds, Flowers, & Arrington, 1991; Edwards & Briers, 2001; Moss & Rome, 1990; Norris, Larke, & Briers, 1990; Roberts, 2006). This research sought to determine if leadership style of the cooperating teacher has an impact on the satisfaction level of the completed student teacher and their decision to enter the profession.

Literature Review/Theoretical Framework

Teacher Shortage

The number of beginning teachers entering the teaching profession has been documented by the American Association of Agricultural Educators for many years. Kantovich (2007) reported previous studies have concluded the deficiency of agricultural teachers entering the profession may be due to the low percentage of graduates who actually decide to enter the profession upon finishing their degree. Kantovich (2007) estimated, based on previous teacher supply and demand studies, of the 785 newly qualified teachers who graduated from a teacher education program in 2007, only 53% would enter the teaching profession. This left a gap in the number of teachers needed to fill the open positions. The previous year had also left positions unfilled with an estimated 40 programs that could not find a qualified agriculture teacher and were unable to operate. In addition, Brown (1995) stated that the recruitment of beginning agriculture teachers is a bigger problem than the number of undergraduates pursuing a degree in agricultural education.

More graduates choosing to enter teaching would immediately provide some relief from the effects of the teacher shortage. One very important key to this solution is working to guarantee the student teaching semester is successful and they are satisfied with the experience (Norris, Larke & Briers, 1990). Multiple studies have researched the impact the cooperating teacher has on the student teacher's sense of satisfaction and success with the teaching intern experience (Deeds, Flowers, & Arrington, 1991; Edwards & Briers, 2001; Garton & Cano, 1996; Harlin, Edwards, & Briers, 2002; Schumacher & Johnson, 1990). Their research identified the essential role cooperating teachers have in preparing beginning teachers to enter the profession.

In order to fill the many open positions each year, university teacher education programs need to effectively train student teachers and place them in cooperating teacher sites where they will build their confidence and hopefully make the decision to enter the teaching field. One way to facilitate this process is to ensure cooperating teachers and student teachers are compatible in leader and follower style and preference.

Personality Types and Leadership Styles

Research in the discipline of Agricultural Education has focused on how personality types impact the cooperating teacher/student teacher relationship. Kitchel (2005) studied the personality type of the cooperating teacher and student teacher to learn if the relationship was impacted due to the personality type of the two parties. He used the MBTI® (Myers-Briggs Type Indicator) to determine the personality type. There are 16 types a person can be categorized into after completing the MBTI®. Kitchel (2005) stated the personality type of the cooperating teacher had little influence on the psychosocial functions, amount of assistance needed and provided, and barriers to success. Kitchel (2005) went on to state "personality type similarity is not influential in determining perceived similarity and satisfaction of interaction" (p.137).

While several studies have been conducted that researched personality as a factor for satisfaction of student teachers (Burriss, Kitchel, Greiman, & Torres, 2006; Kitchel, 2005; Kitchel & Torres,

2007) little work has been done to relate leadership style to the impact a cooperating teacher has on a student teacher. This study was structured around multiple theoretical perspectives. The initial theoretical framework for this research study was Blanchard's Theory of Situational Leadership (see Figure 1.)

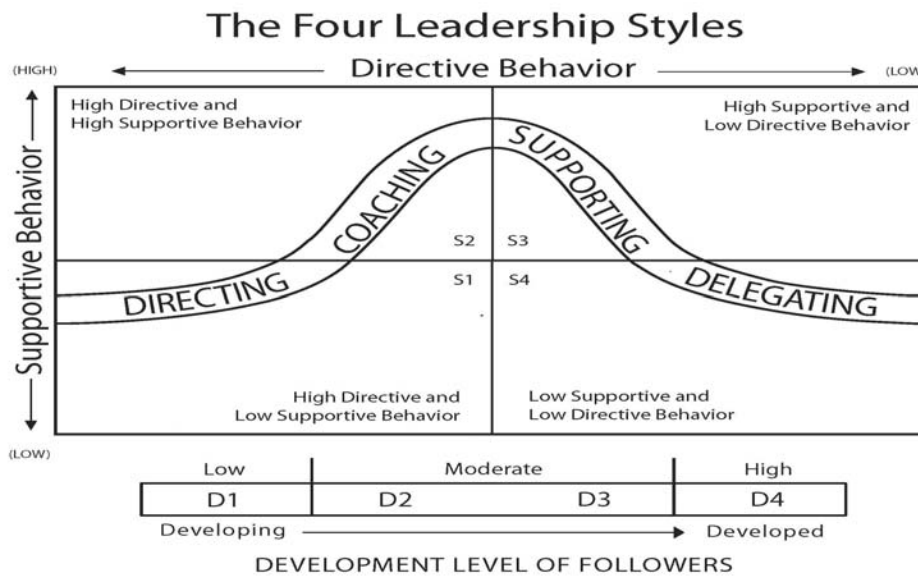

Figure 1. Model of Situational Leadership Theory.

This leadership theory was first developed by Paul Hersey and Kenneth H. Blanchard. There are four fundamental styles each representing a different leadership style. “A person’s leadership style involves some combination of task behavior and relationship behavior” (Hersey & Blanchard, 1993, p. 129). The leader’s preferred leadership style does not always match the follower’s development. This is the key reason to use this model to study the relationship between the cooperating teacher’s leadership style and the student teacher’s satisfaction. Hersey & Blanchard (1993) theorize leaders who consciously match their leadership style to the development level of the follower will produce employees who are more satisfied and competent in their job functions, resulting in more productivity, higher employee morale and lower turnover rates. As follower development increases with experience and self-confidence, the leader is able to shift their leadership style from right to left across the continuum. Ultimately the goal is to develop the followers to a point that which the leader can delegate most activities without concern or question.

Situational Leadership

Hersey and Blanchard developed their theory on situational leadership in 1969 after studying the 3-D management style theory by Reddin (Northouse, 2010). The original theory has been further developed and is used in leadership training programs (Northouse, 2010). This style of leadership requires the leader to adapt to the needs of the follower depending on the situation. The theory has two main components: leadership style and follower development. The leader can display two types of behavior at varying degrees: supportive and directive. The follower can vary based on their commitment and competence (Northouse, 2010).

The leadership style of the cooperating teacher was the focus of this study. Blanchard identified four categories that leaders can be grouped into: Directive, Coaching, Supporting, and Delegating. The relationship between the level of directive and supportive behaviors exhibited by the leader is the measurement for grouping a leader in each category (Northouse, 2010).

The level of follower development is the second part of the model. As followers become more developed in their job role, their level of commitment and competence increases and they will move from D1 (low development) across to D4 (high development). For the purposes of this study, it was assumed the student teachers were in the D1 category because they are excited and committed to doing a good job, but lack the competence to perform it without guidance from the cooperating teacher. As the follower learns more about the job, they can move through the categories until they reach D4 (Northouse, 2010).

Student/Teacher Relationship

Moss and Rome (1990) reported “first year teachers, university supervisors and cooperating classroom teachers were generally pleased with the student teaching experiences. First year teachers agree most strongly that student teaching was a positive experience. All three groups agreed student teaching was the most valuable component of the teacher education program” (p. 31). Researchers in the profession of Agricultural Education have often noted the importance of the relationship between the cooperating teacher and the student teacher in terms of a successful experience (Harlin, Edwards, & Briers, 2002; Kitchel & Torres, 2007; Roberts, 2006; Young & Edwards, 2006).

While it has often been suggested (Roberts, 2006; Roberts, Harlin, & Ricketts, 2006) the student teaching experience has an impact on the student teacher’s decision to teach, there has been no empirical research conducted on the direct effect the cooperating teacher has on that decision. Is it possible that one of the most dominant reasons why beginning teachers choose to accept a teaching position after graduation is the positive relationship they had with their cooperating teacher? It is imperative the effect of the relationship on the decision to teach be considered.

Satisfaction

The theoretical framework, about satisfaction, used for this study is derived from the work of Greiman (2002), Kitchel (2005), Kram (1985) and Hall (1986). This line of research has studied the psychosocial functions involved in mentoring relationships, including student teachers and cooperating teachers. These are: 1) acceptance, 2) counseling, 3) friendship, 4) role modeling and, 5) social.

Kitchel (2005) describes each of the five psychosocial functions based on literature from Hall (1986) and Ragins and McFarlin (1990). The acceptance function relates to the amount of support given to the student teacher to develop their self-confidence. The counseling function relates to the rapport built between the two and the ability to work through problems. The friendship function involves caring about the other individual in ways outside of the normal work experience. Role modeling relates to the demonstration of acceptable behaviors and skills that will help the other individual develop. The fifth function is the social function which relates to the amount of interaction the two parties had outside the normal work environment (Kitchel, 2005).

Another theory used to evaluate satisfaction was the expectation disconfirmation theory (EDT). EDT was developed by Oliver (1977) as a theory on consumer satisfaction after a purchasing decision. The theory focuses on the idea that individuals have expectations about a product or service and after the performance of those items they are either satisfied or dissatisfied with the decision or experience. Disconfirmation can be either positive or negative which will impact the satisfaction (“Expectation Disconfirmation Theory”, 2005).

EDT was used in this research to determine if the needs of the student teacher were met by the cooperating teacher. The student teacher may report their needs were not met (negative disconfirmation) or their needs were met (positive disconfirmation). If there is positive

disconfirmation than satisfaction was achieved. If there is a negative disconfirmation than satisfaction was not achieved.

Statement of the Problem

Teacher education programs in agriculture education must work to fill the many positions available in high school agriculture programs across the country and ensure those graduating with a degree are deciding to enter the teaching field. One way we can begin to do this, is to make sure the student teaching experience is positive. This research was conducted to study the relationship between the cooperating teacher and student teacher, with specific interest on the satisfaction of the student teacher as a function of the leadership style of the cooperating teacher.

Purpose/Objective

The purpose of this study was to determine if the leadership style of the cooperating teacher has an impact on the satisfaction level of the student teacher.

This is a descriptive/correlational research design with the following objectives.

1. Describe characteristics of the student teachers during the 2010 Spring Semester.
2. Quantify satisfaction level of student teachers following the student teaching experience.
3. Identify the leadership style of cooperating teachers as measured by the ELSI- AG.
4. Determine relationship between cooperating teachers' leadership style and student teachers satisfaction level.

Methodology

This study was a non-experimental quantitative study using descriptive-correlation data. The intent was to describe the leadership preference of cooperating teachers based on Hersey & Blanchard's Situational Leadership Theory (Hersey & Blanchard, 1993) and the satisfaction level of the student teacher.

Population

There were two target populations for this study. The first consisted of the current agricultural science instructors in Texas who served as cooperating teachers during the spring semester of 2010 (N = 46) for student teachers at Texas Tech University. These teachers were purposively selected as cooperating teachers based on the characteristics of their program, their willingness to participate and the accessibility of their location. All teachers included in this study had previously served as a cooperating teacher on one or more occasions.

The second target population consisted of the students participating in the spring 2010 student teaching block at Texas Tech University (N = 19). The discrepancy in population sizes existed because several of the schools had multiple teacher programs. The student teachers were traditional certification students who were completing the last semester of their four year program. A census of all student teachers in this semester was conducted.

Instrumentation

Two instruments were used to gather the data for this research study: the Educational Leadership Style Indicator – Agricultural Science Teacher Version (ELSI-AG) developed by Wimmer, Brashears, and Burris (2010) and the Mentoring Relationship Questionnaire (MRQ) developed by Greiman (2002) and further developed by Kitchel (2005). The ELSI-AG built on the literature of Hersey and Blanchard (Hersey & Blanchard, 1969a; Hersey & Blanchard, 1969b; Hersey & Blanchard, 1977; Hersey & Blanchard, 1988; Hersey & Blanchard, 1993) and was used to measure the preferred leadership style of agricultural science teachers. This instrument has been pilot tested, iteratively improved and determined to be valid and reliable. This instrument

includes 20 scenario items with possible responses. Each situation is specific to the profession of agricultural education. The participant must select the response they would most likely perform in the given situation. Responses for the twenty items are recorded and the preferred style of leadership of the teacher is determined according to Blanchard's model. Each teacher is categorized as a Director, Supporter, Coach or Delegator.

The second instrument, the modified MRQ, was used to assess the satisfaction level of the student teacher with their cooperating teacher. It was developed by Greiman after conducting an extensive literature review on mentoring related research (Greiman, 2002). Kitchel (2005) made adjustments to the original instrument by changing the audience to student teachers and cooperating teachers.

For the purpose of this research study, only the student teacher version was utilized. Section A consisted of 15 statements related to the psychosocial support the cooperating teacher provided the student teacher. There were 5 *functions* of psychosocial support and three statements relating to each of the five *functions* (Greiman, 2002). The five categories were acceptance, counseling, friendship, role modeling, and social.

Section B consisted of 28 roles and responsibilities of agriculture teachers. Participants responded by rating the amount of assistance they needed on 28 items using a 5-point Likert-type scale with a range from 1 = never to 5 = considerable. They also responded to the amount they were satisfied with the amount of assistance they received on the same 28 items. They used a 5-point Likert-type scale with a range from 1 = very dissatisfied to 5 = very satisfied.

Section C was made up of two parts. Burris et al. (2006) explained the first part as the similarity between the two parties in the relationship (student teacher and cooperating teacher). The second part of section C was another satisfaction component focused on the overall interaction between the two individuals. Participants provided their opinion using a 7-point Likert-type scale with a range from 1 = strongly disagree to 7 = strongly agree.

Section D asked student teachers open ended questions about the benefits they received from working with their cooperating teacher and barriers to having a more successful student teaching experience. They also answered a question about their future plans to teach high school agriculture. Finally, section E collected demographic information from the students in reference to their school (size, number of instructors in the Ag Ed Program, number of students enrolled in the program) and personal information (age, gender, times per week and hours per week they met with their cooperating teacher).

The reliability of the MRQ was determined by Greiman (2002) and confirmed by Kitchel (2005). Greiman (2002) calculated a Cronbach's alpha for three of the sections; psychosocial functions (.97), perceived similarity (.98) and perceived satisfaction (.99).

Data Collection

The cooperating teachers were contacted three times via email. The first contact was one week prior to the release of the questionnaire to introduce them to the research. Participants were then emailed access to the questionnaire on Zoomerang.com at the beginning on March. The follow-up reminders were sent exclusively using email. There were 46 cooperating teachers included in

the sample due to multiple teacher programs. The student teachers completed the modified MRQ at the completion of the semester.

Analysis

Data were analyzed using appropriate statistics within SPSS version 17.0. Data were summarized using measures of central tendency and variability. Cooperating teachers were categorized into one of four preferred leadership styles using the sum function within SPSS. The category receiving the largest number of responses on the ELSI-AG was determined to be the cooperating teacher's preferred leadership style. This was recorded as categorical data.

Student teacher responses to Likert-type items were recorded as numerical data in SPSS. Additional variables were created to determine mean scores of five distinct constructs of the psychosocial function. These construct scores were calculated to maintain the scale of the individual items on the instrument. The student teachers disconfirmation scores were calculated from their scores on the amount of support needed compared to the amount of support received. Overall perceived satisfaction with the cooperating teacher relationship was calculated through mean scores from that section. Student teachers also provided demographic data.

Findings

The first objective was to describe characteristics of the student teachers during the 2010 Spring Semester. Table 1 shows the gender of the student teachers and size of school in this research study. The majority (63.2%, $n = 12$) of the sample were female. The majority of student teachers (63.2 %, $n = 12$) were in a 1A or 2A size school, with two students (10.5%) at 3A, one student (5.3%) at a 4A, and four students (21.1%) at 5A size schools. The size of school is determined by the number of students enrolled Kindergarten through 12th grade. The following are the enrollment breakdowns: 1A = 199 students and below, 2A = 200-429, 3A = 430-989, 4A = 990-2064, 5A = 2065 students and above. The average student teacher age was 22.63 (SD = 1.92) with the majority of student teachers ($n = 16$) being between 21-23 years of age.

Table 1

Gender and Age of Student Teachers and Size of Cooperating School (n = 19)

	Frequency	Percent	Mean	SD
Gender				
Male	7	36.80		
Female	12	63.20		
Age			22.63	1.92
Size of School				
1A	6	31.60		
2A	6	31.60		
3A	2	10.50		
4A	1	5.30		
5A	4	21.10		

The second objective was to determine the satisfaction level of student teachers. Each of the 19 students completed the modified MRQ. There were three measures of satisfaction within the instrument. The first component sought to measure the satisfaction in terms of the degree the student teacher's psychosocial functions were met by the cooperating teacher. This consisted of five constructs that were totaled into a sum score. On a scale from 1 to 7 the five psychosocial functions received the following mean scores: social (M = 3.37), acceptance (M = 5.38), counseling (M = 5.37), friendship (M = 5.10), and role model (M = 4.46). The overall psychosocial score ranged from 6 to 33.33 (M = 23.68, SD = 8.19).

The second component used to measure satisfaction related to disconfirmation theory. This sought to examine the amount of support needed by the student (scale of 1-5) compared to the amount they received (scale of 1-5) on 28 specific items. Each item score was calculated by subtracting the amount of assistance needed from the amount of assistance provided. This resulting score would indicate negative values when the amount of assistance needed was more than provided. In turn, it was positive when the amount of assistance provided was more than what was needed. The scores ranged from -31.00 to 85.00 (M = 45.62, SD = 33.78).

The third component was the level of satisfaction the student teacher perceived they received from the relationship with their cooperating teacher(s). The range of scores for the five items on the instrument was 1.00 to 7.00 (M = 5.60, SD = 1.79). Score for all measures of satisfaction can be seen on Table 2.

Table 2

Satisfaction Level of Student Teachers (n = 27)

	Min	Max	Mean	SD
Psychosocial ¹	6.00	34.00	23.68	8.19
Social ²	1.00	7.00	3.37	2.30
Acceptance ²	1.00	7.00	5.38	1.64
Counseling ²	1.00	7.00	5.37	1.60
Friendship ²	1.00	7.00	5.10	1.66
Role Model ²	1.00	7.00	4.46	1.83
Disconfirmation ³	-31.00	85.00	45.62	33.78
Perceived Satisfaction ⁴	1.00	7.00	5.60	1.79

¹Sum of the five constructs below.

²Likert scale with 1 = Not at all and 7 = Very Large Extent

³Calculated index. Dual column Likert-type items. Needed assistance (1=Never and 5=Considerable) subtracted from Assistance received (1=Very Dissatisfied and 5=Very Satisfied) and summed across 28 items.

⁴Likert scale with 1 = Strongly Disagree and 7 = Strongly Agree

The third objective was to identify the leadership style of cooperating teacher as measured by the ELSI- AG. The response rate for the cooperating teachers was 63% (n = 29). Table 3 illustrates the statistics for the leadership styles. The majority (72.4%, n = 21) of cooperating teachers were classified in the supporting style. Most preferred leadership style was calculated using a summation of responses from each of the four categories and using the one with the most responses.

Table 3

Most Preferred Leadership Style of Cooperating Teacher (n = 29)

Leadership Style	Frequency	Percent
Directing	3	10.3
Coaching	5	17.2
Supporting	21	72.4
Delegating	0	0

In addition to the summation score used to identify the most preferred leadership style, responses within each category were totaled and descriptive statistics calculated. These can be seen in Table 4. For example: There were twenty items on the ELSI-AG, each with four possible responses. Each response indicates their preference for one of the four styles. If the cooperating teacher selected the Coaching response five times, that number was recorded under the Coaching category. The distributions of responses in the four categories allow the researcher to quantify the teacher preference for each leadership style rather than just their most preferred.

Table 4

Leadership Style Scores of Cooperating Teacher by Category (n = 29)

Leadership Style	Min ¹	Max ²	Mean	SD
Directing	.00	10.00	3.86	2.49
Coaching	1.00	10.00	5.17	2.16
Supporting	2.00	15.00	8.83	3.63
Delegating	.00	6.00	1.97	1.55

¹Lowest possible minimum = 0

²Highest possible maximum = 20

The fourth objective was to determine the relationship between cooperating teacher's leadership style and student teacher's satisfaction level. Pearson Product Moment Correlations were calculated using the Most Preferred Leadership Style (categorical) and the score for each of the satisfaction scales and subscales. The resulting correlation table can be seen in Table 5. The magnitude of the relationship is defined based on Davis (1971) descriptions. The correlation between the main leadership style and the acceptance function was moderate ($r = .39$) as was the correlation between main leadership style and perceived satisfaction ($r = .33$). All of the other correlations were low or negligible. All correlations were positive.

Table 5

Pearson Product Moment Correlation between Satisfaction Items and Most Preferred Leadership Style (n = 29)

	Main Leadership Style
Psychosocial	.23
Acceptance	.39
Counseling	.29
Friendship	.27
Social	.01
Role Model	-.16
Disconfirmation	.22
Perceived Satisfaction	.33

Each score for the four categories of cooperating teacher leadership style was also correlated to the scales and subscales of satisfaction by the student teachers. The correlations can be seen in Table 6. Correlations were positive and moderate between the supporting leadership style and acceptance ($r = .41$), counseling ($r = .44$), and friendship ($r = .37$) functions; disconfirmation ($r = .42$) and perceived satisfaction ($r = .42$). The relationship between the coaching leadership style and the same measurements yielded negative moderate correlations; acceptance ($r = -.39$), counseling ($r = -.31$), and friendship ($r = -.39$) functions; disconfirmation ($r = -.46$), and perceived satisfaction ($r = -.40$). All other correlations were either positive or negative low or negligible relationships.

Table 6.

Correlations between Satisfaction Measurements and Categorical Leadership Style (n = 29)

	Directing	Coaching	Supporting	Delegating
Psychosocial	-.17	-.29	.28	-.01
Social	-.02	-.07	-.05	.23
Acceptance	-.22	-.39	.41	-.07
Counseling	-.28	-.31	.44	-.17
Friendship	-.14	-.39	.37	-.13
Role Model	-.16	-.20	.23	-.02
Disconfirmation	-.11	-.46	.42	-.18
Perceived Satisfaction	-.18	-.40	.42	-.15

Conclusions/Recommendations

The researchers recognize the small population size in this study is a limiting factor however; several important conclusions should lead to expanded research in this area. The student teaching population was small but representative in gender, age and intent to teach as previous teaching blocks at the same university. Cooperating teachers were purposively selected based on programmatic characteristics as is done at most teacher training programs. These two variables probably will not vary significantly from year to year; therefore, if strides are to be made in assuring more students enter the teaching field, we will have to consider other variables that contribute to the attrition of student teachers. This preliminary study indicates that the leadership style of the cooperating teacher could be a variable of interest.

It was determined cooperating teachers largely preferred to exhibit the supporting leadership style. This style indicates the followers (in this case, the student teachers) have the skill set and the ability to complete the necessary tasks, but need reassurance and communication in order to be successful. While this is a worthy goal, it is premature to assume all our student teachers are operating at that level when entering the field. The ultimate goal of situational leadership theory is to match the style to the current situation, not to operate in a preferred style in all situations. The cooperating teacher should be able to determine the student teacher's development level and motivation and match their style to the student's needs. As the student becomes more competent, the teacher should recognize changes and alter their leadership style accordingly. All cooperating teachers should aspire to the delegating style by the completion of the student teacher's term.

It can also be concluded, as leadership style moves from directing linearly to delegating, student satisfaction increased. While correlations between satisfaction scores and preferred leadership style ranged from negligible to moderate (Davis, 1971), all were positive when the main leadership style was supporting, indicating increased satisfaction with higher levels of leadership. When correlations within the individual styles were calculated, it was apparent that the supporting category was related positively to higher student satisfaction.

Recommendations

There are several recommendations from the results of this study. One recommendation is to conduct a larger study to verify the results of this research. Also, more detailed demographic data on both the student teachers and cooperating teachers should be collected. An instrument should be created to establish student teachers' development level upon entering and leaving the student teaching experience to better gauge their growth.

It is recommended a cooperating teacher training workshop be developed and implemented that will be used to explain the use of the different leadership styles and how to use each appropriately when working with their student teachers.

Further research on the impact of matching student teacher development level to preferred leadership style of the cooperating teacher should be designed and implemented. The researchers also recognized the need to collect data from the student teacher regarding their intent to teach. Future research will seek to measure the impact of matching student teacher development level to preferred leadership style of the cooperating teacher.

References

- Barnes, R. L., & Camp, W. G. (2002). Desirable characteristics of cooperating centers for agricultural teacher education. *Proceedings of the 2002 Southern Agricultural Education Research Conference*.
- Brown, J.L. (1995). *Patters of supply and demand of teachers in agricultural education since 1965*. Unpublished honors thesis, The Pennsylvania State University.
- Burris, S., Kitchel, T., Greiman, B.C, Torres, R.M. (2006). Beginning and mentor agriculture teacher' perceptions of psychosocial assistance, similarities, and satisfaction. *Journal of Agricultural Education*, 47(4), 64-75.
- Davis, J.A. (1971). *Elementary survey analysis*. Englewood, NJ: Prentice-Hall.
- Deeds, J. P. (1993). A national study of student teaching requirements in agricultural education. *Proceedings of the 20th National Agricultural Education Research Meeting*, 20, 219-225.
- Deeds, J. P., Flowers, J., & Arrington, L. R. (1991). Cooperating teacher attitudes and opinions regarding agricultural education student teaching expectations and policies. *Journal of Agricultural Education*, 32(2), 2- 9.
- Edwards, M. C., & Briers, G. E. (2001). Cooperating teachers' perceptions of important elements of the student teaching experience: A focus group approach with quantitative follow-up. *Journal of Agricultural Education*, 42(3), 30-41.
- Expectation Confirmation Theory. (2005). Retrieved from <http://www.istheory.yorku.ca/ect.htm>
- Garton, B. L., & Cano, J. (1996). The relationship between cooperating teachers' and student teachers' use of the problem solving approach to teaching. *Journal of Agricultural Education*, 37(1), 48-55.
- Greiman, B.C. (2002). *Providing professional and psychosocial assistance for beginning agriculture teachers: The perceptions of formal mentors and novice teachers*. Unpublished doctoral dissertation, University of Missouri, Columbia.
- Grimmett, P.P. & Ratzlaff, H.C. (1986). Expectations for the cooperative teaching role. *Journal of Teacher Education*, 37(6), 25-30.
- Hall, D.T. (Ed.). (1986). *Mentoring in the workplace*. San Fransico: Jossey-Bass, Inc., Publisher.
- Harlin, J. F., Edwards, M. C., & Briers, G. E. (2002). A comparison of student teachers' perceptions of important elements of the student teaching experience before and after an 11-week field experience. *Journal of Agricultural Education*, 43(3), 72-83.
- Hersey, P., & Blanchard, K.H. (1969a). Life-cycle theory of leadership. *Training and Development Journal*, 23, 26-34.
- Hersey, P., & Blanchard, K.H. (1969b). *Management of organizational behavior: Utilizing human resources*. Englewood Cliffs, NJ: Prentice Hall.
- Hersey, P., & Blanchard, K.H. (1977). *Management of organizational behavior: Utilizing human resources (3rd ed.)*. Englewood Cliffs, NJ: Prentice Hall.
- Hersey, P., & Blanchard, K.H. (1988). *Management of organizational behavior: Utilizing human resources (5th ed.)*. Englewood Cliffs, NJ: Prentice Hall.

- Hersey, P., & Blanchard, K.H. (1993). *Management of organizational behavior: Utilizing human resources (6th ed.)*. Englewood Cliffs, NJ: Prentice Hall.
- Hussar, W.J. (1998). *Predicting the need for newly hired teachers in the United States to 2008-09*. Retrieved from United States Department of Education, National Center for Education Statistics Website: <http://nces.ed.gov/pubs99/1999026.pdf>
- Kantovich, A. J. (2007). *A national study of the supply and demand for teachers of agricultural education from 2004-2006*. American Association of Agricultural Educators.
- Kitchel, T. (2005). *Personality type as a predictor of interaction between student teachers and cooperating teachers*. Unpublished doctoral dissertation, University of Missouri, Columbia.
- Kitchel, T. & Torres, R. M. (2007). The influence of personality type on the extent cooperating teachers provide psychosocial assistance to student teachers. *Journal of Agricultural Education*, 47(4), 134-44.
- Kram, K.E. (1985). *Mentoring at work*. Boston: Scott, Foresman and Company.
- Marso, R. N., & Pigge, F. L. (1997). A longitudinal study of persisting and nonpersisting teachers' academic and personal characteristics. *The Journal of Experimental Education*, 65(3), 243-254.
- Moss, J. W., & Rome, C. (1990). Satisfaction with agricultural education student teaching. *Journal of Agricultural Education*, 31(2), 29-34.
- Norris, R. J., Larke, A. Jr., & Briers, G. E. (1990). Selection of student teaching centers and cooperating teachers in agriculture and expectations of teacher educators regarding these components of a teacher education program: A national study. *Journal of Agricultural Education*, 31(1), 58-63.
- Northouse, P.G. (2010) *Leadership: Theory and practice*. Thousand Oaks, CA: Sage Publications, Inc.
- Obama's Remarks on Education. (2010). Retrieved from <http://blogs.wsj.com/washwire/2009/03/10/obamas-remarks-on-education-2>
- Oliver, R.L. (1977). Effect of expectation and disconfirmation on postexposure product evaluations- an alternate interpretation. *Journal of Applied Psychology*, 62(4), 480.
- Osborne, E. W. (Ed.) (n.d.). *National research agenda: Agricultural education and communication, 2007-2010*. Gainesville, FL: University of Florida, Department of Agricultural Education and Communication.
- Ragins, B.R., & McFarlin, D. B. (1990). Perceptions of mentor roles in cross-gender mentoring relationships. *Journal of Vocational Behavior*, 37, 321-339.
- Roberts, T.G. (2006). Developing a model of cooperating teacher effectiveness. *Journal of Agricultural Education*, 47(3), 1-13.
- Roberts, T.G., Harlin, J.F., & Ricketts, J.C. (2006). A longitudinal examination of teaching efficacy of agricultural science student teachers. *Journal of Agricultural Education*, 47(2), 81-92.
- Schumacher, L. G., & Johnson, D. M. (1990). Time series analysis of agricultural education student teachers' perceptions of agricultural mechanics lab management competencies. *Journal of Agricultural Education*, 31(4), 2-8.

Schumann, H.B. (1969, January). The cooperating teacher's role in student teaching. *The Agricultural Education Magazine*, 41(7), 156.

Wimmer, G., Brashears, M. T., & Burris, S. (2010, February). *Developing a Leadership Assesment Instrument for Cooperating Teachers*. Refereed poster session presented at the Southern Association of Agricultural Scientists Agricultural Education Section, Orlando, FL.

Young, R.B., & Edwards, M.C. (2006). A comparison of student teacher's perceptions of important elements of the student teaching experience before and after a 12-week Field experience. *Journal of Agricultural Education*, 47(3), 45-57.

Developing and Testing An Integrated Global Curriculum for an Introductory High School Agricultural Education Class

Katrina R. Sharp, T. Grady Roberts, University of Florida

Abstract

The purpose of this study was to assess high school students' knowledge and attitudes towards international agriculture and to design and evaluate a curriculum to give students a brief introduction about Latin American agriculture. A four lesson curricula based on the themes of Introduction to Latin America, Sustainability, Agroforestry, and Tropical Crops was designed after the lead author attended a study abroad course in Costa Rica. A pre/post test was developed to assess students' knowledge about Latin American agriculture and a curricula evaluation survey was developed to assess the effectiveness of the curricula. An attitude survey was also developed to assess students' thoughts about international agriculture. Twenty students from a ninth grade introductory agricultural education class were taught one lesson per week over a four week period and completed an attitude survey, pre and post-test, and curricula evaluation survey. Test scores increased over fifty percent between the pre and post test administrations. Students had mainly neutral views on international agriculture. However, they indicated they did not feel prepared to enter into a globalized workforce. It is recommended that further research be conducted on secondary students' opinion about international agriculture within the agricultural curriculum. It is also recommended that more global elements of agriculture be included into current curriculum to prepare students to enter a global workforce upon graduation.

Introduction

The United States and the agricultural industry are no longer isolated as they once were. Both are now interdependent with the rest of the world. As the world becomes more globalized, students are encouraged to prepare to enter into a more internationalized agricultural industry. Ibezims and McCracken (1994) declared that if students are to compete effectively in the internationalized workforce, it is adamant they need to understand the role globalization plays in agriculture. However, high school students and college undergraduates show a deficiency in knowledge regarding international issues, agricultural policies, people, and cultures (Wingenbach, Boyd, Lindner, Dick, Arispe, & Haba, 2003). This may put students at a disadvantage when they enter into a workforce that is constantly evolving to accommodate global changes (Radhakrishna, Leite, & Domer, 2003). Agricultural education programs are not keeping pace with the rapid demand for global education. High school participants of a Costa Rican travel seminar thought that learning about international agriculture was important; notwithstanding they received little instruction about the subject in their secondary agricultural education program (Connors, 2004). This lack of global instruction in the agricultural education curricula is troubling.

To understand why this is occurring, research is needed on internationalizing agricultural education. A majority of research on students' perceptions, attitudes and beliefs has focused primarily on college undergraduate students. There is limited research about high school students who participate in agricultural programs. According to the U.S. Census Bureau's (2007) report

on educational attainment, 84% of the population over the age of 25 completed high school. Over half (54%) had at least some college education. Most research focuses primarily on undergraduate students and overlooks a large part of the population that has completed high school but has not gone to college. High school students will enter the workforce either with or without a college degree. Further research concerning their perceptions, attitudes, and beliefs of internationalization are needed.

Understanding how high school students view international agriculture is an important step to the development of international agricultural curricula. With so few international curricula available there is a pressing need for expansion in order to educate high school agriculture students and prepare them for the globalized industry.

Literature Review

The Development of Adolescent Attitudes

Adolescence is a period of transition from childhood to adulthood. It is marked by biological, cognitive, and social changes (Steinberg, 2008). Research suggests that it is these cognitive and psychosocial changes that make the introduction to multicultural education optimal (Manning, 1999). A key developmental task of adolescents is to form an identity (Erikson, 1974), which is marked by a period of exploration about many issues in order to form an identity of oneself (Marcia, 1966). During this time period adolescents are forming opinions about the world around them, and are typically more receptive to new information and ideas. Adolescents may have opinions and attitudes already formed, but they are typically more flexible and willing to change/incorporate new information. However, as adolescences grow older they are less likely to reconsider opinions and attitudes that have already been formed (Klimstra, Hale, Raaijmakers, Branje, & Meeus, 2010). Many college courses introduce new topics well after people have already formed opinions and attitudes that can influence how they perceive a subject. Adolescents on the other hand may reconsider previously held views or beliefs if presented with new information or ideas. As such this makes secondary education the ideal backdrop to expose students to new information since as adolescents they may be more receptive.

Students' Attitudes Towards International Agriculture

“Global perspective is a relatively new concept; therefore, the research literature on this topic is embryonic” (Zhai & Scheer, 2004, p. 40). The literature that exists on this topic focuses primarily on post-secondary schools; little research has been done at the secondary school level. Zhai and Scheer conducted a study on agriculture students at The Ohio State University concerning their attitudes towards international agriculture, and found that students studying agriculture at the post-secondary level have a moderate global perspective. Similar research on post-secondary students' attitudes and beliefs towards international agriculture has been conducted, however it is difficult to find studies implemented at the high school level.

One study conducted by Radhakrishna, et al. (2003) examined high school students' beliefs and attitudes regarding international agricultural concepts. The study found that students felt they needed more information on agriculture from a global perspective. They felt curricula was needed that would prepare them adapt to changes in agriculture as it becomes more worldwide (Radhakrishna et al., 2003). This same study concluded that more research

concerning the attitudes, perceptions, and knowledge of students was necessary, as well as research to design, execute and assess international agricultural curricula.

A group of high school students who participated in a Costa Rican travel seminar had positive attitudes towards learning about international agriculture and traveling (Connors, 2004). The students were also in agreement that knowledge in global agriculture would be important for their careers and would help them in the future. They indicated that they believed that international agriculture should be taught at the secondary level as well.

International Curriculum in Schools

As the years have progressed there has been a growing awareness that our society has become globally interdependent and is no longer isolated as it once was (Tye & Tye, 1992). The education system in the United State adapts to social movements by changing the curricula to match the current times. In the past decade various reform movements have prompted educators to incorporate international concepts into high school curricula (Elliot & Yanik, 2002). However, this does not mean there is a uniform agreement in the best way to achieve this result, or even that the curricula need to be more globalized.

Gibson and Hillison (2005) stated that there is debate over the best way to deliver instruction of international agriculture. A possible reason for the this problem is that the definition of agriculture can be subjected to a narrow interpretation which in turn can lead to little flexibility in the subject matter of agricultural education programs (Acker, 1999). Almost half the students involved in the Costa Rica travel seminar reported that they had received less than one week of instruction in international agriculture (Connors, 2004). This could be a result of educators not considering international agriculture as belonging to “traditional” agriculture education.

Methods to increase global knowledge include study abroad programs and interactions with international students. However, money, time, diversity of the school population and number of participants are all factors that limit the effectiveness of such methods. An alternative method is to develop curricula based on agriculture from a wide variety of countries to “integrate...experiences into the broader agricultural curriculum” (Boyd, Felton, & Dooley, 2004, p. 64). Little international curricula are available for high school agriculture teachers. The development of such curricula has tremendous future application. For students to be fully prepared to enter into the global workforce development of such curricula is essential (Radhakrishna et al., 2003). This method immerses high school agriculture students into a different culture and enables them to learn about international agricultural issues without leaving the classroom.

Research Purpose and Objectives

The purpose of the research project was to determine how an international Agriscience curricula would affect high school Agriscience students. The research objectives were to: (a) assess students’ knowledge of international agriculture and current issues, (b) assess students’ attitudes of international agriculture, and (c) determine student perceptions of the curricula.

Methods

Curricula Development

The curriculum design was largely influenced by the lead author attending a three-week study abroad program in Costa Rica. The program was sponsored through the University of Florida and titled *Sustainable Agriculture and Social Entrepreneurship in the Tropics: Experiential Learning in Costa Rica with EARTH University*. From May 20, 2009 to June 10, 2009 participants of the study abroad program studied animal science, soil science, agroforestry, and sustainability. Throughout the course, pictures, interviews, and notes from lessons were recorded with the purpose of providing background research for a curricula based on Costa Rican and Latin American agriculture.

Upon return from the study abroad program, curricula development began. The data collected from Costa Rica, supplemented with information collected from the Internet, was used. Based on the data collected, it was decided that the curricula should focus on four broad themes titled *Introduction to Latin America, Sustainability, Agroforestry, and Tropical Crops*.

Learning objectives were designed in order to comply with the National Council for Agricultural Education's *National Agriculture, Food and Natural Resources (AFNR) Career Cluster Content Standards* (<http://www.teamaged.org/council/>) whenever possible. Instructional material included PowerPoint presentations, videos, readings, individual writings, and group activities. The lesson plans were reviewed by three doctoral students in agricultural education at the University of Florida and revised accordingly. The curriculum was designed to take one school week. Four days were devoted for instruction. One day was used for evaluation. The lesson titles included: Latin America and Common Agricultural Practices, Sustainability, Agroforestry, and Tropical Fruits, Companies and Business.

The curricula were designed to give students a brief introduction to international agriculture from a tropical perspective in Latin America. The objective for *Lesson 1: Introduction to Latin America* was to introduce students to the region. The lesson plan contained a PowerPoint presentation on Welcome to Latin America, Aquaculture, and Organic Farming. In addition video clips and websites were used. The lesson plan was created in the lecture-note taking format.

Lesson 2: Sustainability focused on defining the term sustainability. It included having each student form an opinion about sustainable agriculture. This was done through the use of a lecture that included a PowerPoint presentation, the creation of a newspaper worksheet called *The Sustainable News*, and essay writing. The lesson plan has elements of lecture-note taking, group work, and individual work built into it.

Lesson 3: Agroforestry focused on defining four agroforestry practices, inferring their advantages, and being able to visualize how each practice works. The lecture was presented through PowerPoint to the students. In addition they read a handout describing the practices in greater depth, and broke into groups to infer advantages of agroforestry. Lastly the students applied the practices to hypothetical scenarios and matched agroforestry practices to a map counterpoint. The lesson plan had a higher proportion of group work compared to individual work than previous lesson plans.

Lesson 4: Tropical Fruits, Companies and Business was designed to introduce students to tropical crop such as pineapple, bananas, coffee, and cacao that were imported into the United States. Using a lecture with a PowerPoint presentation, students were shown pictures of each crop and asked to identify the particular tree and fruit. Students were also shown short video clips produced by the Costa Rican Doka Coffee Estate. Also a PowerPoint presentation on the processing of cacao was shown. A handout containing the logos of companies that import tropical crops was given to students in order to show them that these major brands do business all over the world. A cross-cultural quiz was given orally to students to increase their awareness of the differences of business practices around the globe. Students were made aware that when conducting business internationally methods differ. The lesson plan was primarily group-oriented but there was some individual work.

Sample

A high school in a rural community in Florida with a ninth grade introductory agricultural education class was chosen to participate in the study due to its proximity to the University of Florida. In addition the curricula was designed for a ninth grade agriculture class. The class roster indicated that thirty students were enrolled in the course. No formal demographic data was collected by the researcher, but based on informal observation it appeared that the majority of the class was White with more there being slightly more males than females.

Implementation

Implementation of the curricula research began on November 4, 2009 and concluded on November 23, 2009. Prior to beginning the research, students were briefed about the project and what was expected of them should they choose to participate. They also received Internal Review Board (IRB) parental consent forms with instructions to return them signed to the teacher by the following Monday.

The first day of research, students and the teacher filled out the IRB consent forms, took an attitude/ perception survey and students did the pre-test (Oct. 28). On Mondays and/or Wednesdays (Nov. 4, Nov. 9, Nov. 16, Nov. 18,) students were instructed for fifty minutes in international agriculture using the designed curricula. On the last day of research, November 23rd students were given five minutes to review their notes. They then were administered the post-test which was followed by the curricula evaluation survey.

Instrumentation

Several instruments were used to assess the stated research objectives: a knowledge test, attitude survey, and a curricula evaluation survey. All instruments were administered face to face by the researcher. The use of a pre/post-test was used to assess the knowledge research objective. The pre/post-test consisted of twenty-one questions with a point scale of one hundred possible points. The following types of questions were on the pre/post-test: (a) multiple choice, (b) short answer, (c) true or false, (d) list, (e) matching, and (f) essay. The pre/post-test was designed to assess students' knowledge on agroforestry practices, general knowledge of the Latin American region and cross-cultural business awareness, the concept of sustainability and the feasibility of implementing sustainable agricultural practices, and tropical crops produced in Latin America. Questions were developed using the learning objectives of each lesson plan. The assessment was

reviewed by an agricultural education professor at the University of Florida who teaches educational assessment.

An attitude survey developed by Radhakrishna et al. (2003) was modified and used for the study. The modified survey consisted of ten statements designed to assess students' thoughts about international agriculture and its relevance to them. Student response was measured using a five point rating-scale (1 = strongly disagree to 5 = strongly agree).

A curricula evaluation survey was used to assess students' opinion on the curricula. The survey consisted of seven statements about the effectiveness of the curricula and a free response question at the end. Student response was measured using a five-point rating-scale (1 = strongly disagree to 5 = strongly agree). An open-ended question was included and asked for recommendations, comments and concerns about the curricula.

Data Analysis

The pre/post test scores were converted from a point scale into percentages in order to analyze the data. The original test was based on a one hundred-point scale. After analyzing the data, one question was excluded due to confusion by the students. The final point scale was ninety-six instead of one hundred points.

Limitations

Due to the nature of the convenient sample the results of the study are limited to just this group of students. Another limitation of this study is that the protocol was implemented over a four week period so the long term impacts of this study are unknown. Given that this protocol was implemented over a four week period, complete data was not collected from every student due to subject mortality. The sample of study was predominately white so the impact of this curricula on a diverse more student group is unknown.

Results

With a class roster of thirty students, IRB forms were collected from twenty-four. Of the twenty-four students, complete data were collected from twenty. This culminated in a response rate of 83.3%. The other data was rendered ineligible due to absences, and/or students not returning IRB forms.

Objective 1: Assess students' knowledge of international agriculture

Students' received a pre-test on the first day of research. This determined their knowledge of Latin American agriculture, agroforestry practices, tropical crops, and their opinion on sustainability. On the final day, students were given a post-test. The test was scored on ninety-six possible points. The average test score for the pre-test was 30 percent ($SD = 7.3$). The range of the pre-test was between 17 percent and 44 percent. Test results were rounded to the nearest whole number. On average students left 60 percent of written responses blank. Fifty percent ($n = 10$) of students indicated they supported sustainable agriculture but did not give reasons for their support. Forty-five percent ($n = 9$) of students left the essay blank and one student wrote he/she did not support sustainable agriculture because he/she knew nothing about it.

Students received a post-test (same test as the pre-test) upon the conclusion of curricular instruction. They were given five minutes to study before taking the exam. The average test score for the post-test was 61 percent ($SD = 18.57$). The range for the post-test was between 26 percent and 90 percent. Test results were rounded to the nearest whole number. Figure 1 shows each student's percentage of correct answers on the pre-test and post-test. Students showed significant improvement (majority by over fifty percent) in their scores between the pre and post test. It was interesting to note students' responses to the sustainability essay on the post-test in comparison to the pre-test. Sixty-five percent of students ($n = 13$) support sustainable agriculture; fifteen percent of students ($n = 3$) did not support sustainable agriculture. In addition, 15 percent ($n = 3$) left the question blank and one student was undecided. Responding students supported their opinions with clear arguments.

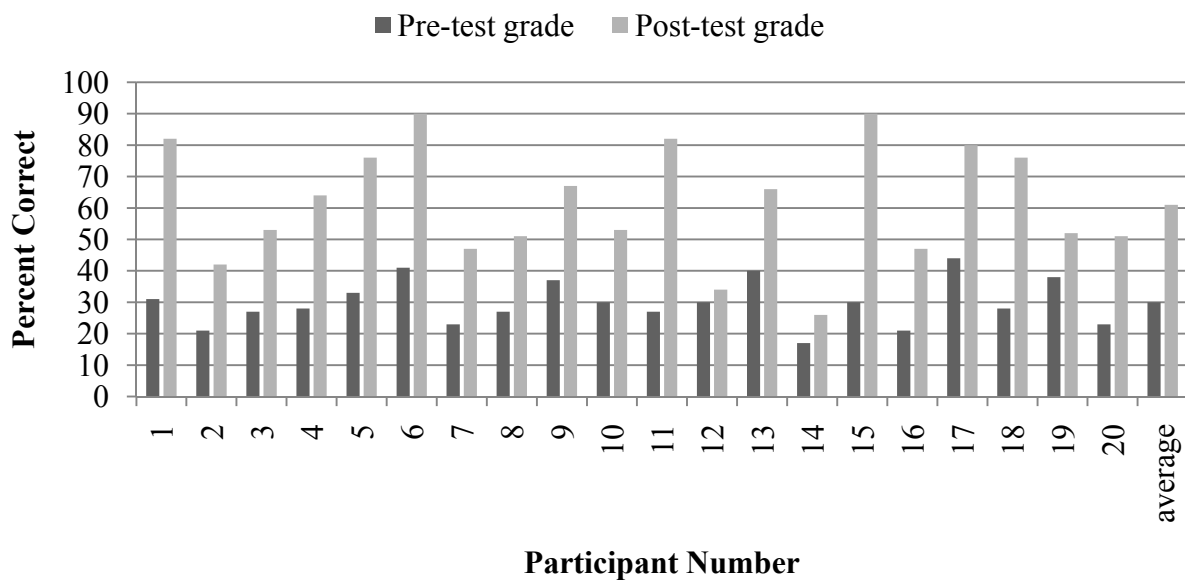

Figure 1. Comparison of each student's percent of correct answers on the pre/post test.

Objective 2: Assess students' attitudes of international agriculture

Students were asked to indicate using a five-point rating scale (1 = strongly disagree to 5 = strongly agree) their attitudes about international agriculture (see Table 1). Students generally responded neutrally to the international agricultural statements. The mean ranged from a low of 2.45 ($SD = 1.14$) (*I am prepared to enter into a global workforce*) to a high of 4.3 ($SD = .80$) (*I believe world events will have an impact on American agriculture*).

It should be noted that students responded negatively to two other questions: *I would consider working overseas in some area of agriculture* ($M = 2.7, SD = 1.26$) and *I would like to travel to another country and learn about their agricultural methods* ($M = 2.95, SD = 1.50$).

Table 1
Student Attitude Survey on International Agriculture

Statement	Frequency					Mean
	SD	D	N	A	SA	
1. I believe world events will have an impact on American agriculture.	0	0	4	6	10	4.30
2. I believe I can learn more about international agriculture in my Agriscience class.	0	2	4	11	3	3.75
3. I believe learning about international agriculture is important.	0	1	9	5	5	3.70
4. I believe American agricultural production is more sustainable than other countries.	0	1	10	6	3	3.55
5. I want to learn more about international agriculture.	2	1	7	9	1	3.30
6. My local community is affected by world events.	1	1	11	6	1	3.25
7. I think my agriculture classes currently have enough of an international focus.	1	2	12	5	0	3.05
8. I would like to travel to another country and learn about their agricultural methods.	4	5	4	2	5	2.95
9. I would consider working overseas in some area of agriculture.	3	8	3	4	2	2.70
10. I am prepared to enter into a global agricultural workforce.	4	8	4	3	1	2.45

Objective 3: Determine the effectiveness of the curricula

Students were asked to indicate using a five-point rating scale (1 = strongly disagree to 5 = strongly agree) to evaluate the curricula and pre/post test (see Table 2). Overall, students had a slightly positive opinion about the curricula. No students strongly disagreed with any of the statements. The range of the mean was between 3.25 ($SD = 1.02$) (*the assignments challenged me*), to 4.25 ($SD = .85$) (*I was able to ask questions and participate during the lessons*). There were no negative responses to any of the statements ($M = 2.99$ or less).

Students also responded to an open-ended question asking for recommendations, comments and concerns about the curricula. Fifty percent of students ($n = 10$) responded to the question. Student responses were categorized into the following: “it was ok” ($n = 2$), “not challenging” ($n = 1$), “liked it” ($n = 4$), and “lessons were well prepared” ($n = 3$).

Table 2
Student Curricula Evaluation Survey

Statement	Frequency					Mean
	SD	D	N	A	SA	
I was able to ask questions and participate during the lessons.	0	1	2	8	9	4.25
The directions were clear and easy to follow.	0	0	4	9	7	4.15
The test questions were taken directly from what was learned in class.	0	1	4	10	5	3.95
I learned a lot about international agriculture.	0	2	3	10	5	3.90
The activities achieved their objectives.	0	1	5	10	5	3.85
I found the lessons to be engaging and interesting.	0	2	8	5	5	3.65
The assignments challenged me.	0	5	8	4	3	3.25

Conclusions and Discussion

Objective 1: Assess students' knowledge of international agriculture

The curricula designed to increase students' knowledge in international agriculture was moderately successful. Students showed an increased knowledge between the pre and post test however half of the individual scores were below a passing grade (60% or better). A factor that could have skewed results is that students did not study or prepare for the post-test. Students were aware that the test did not affect their grade in the class and therefore faced no consequences if they did poorly on the test. Giving students five minutes to study before the test was an attempt to overcome the obstacle that students did not spend any time outside of the class studying for the post-test. This not compensate for additional studying of material.

Students responded very well to the agroforestry portion of the course and the tropical crops lesson plans. However, based on test scores it appears there is some confusion between sustainable agricultural practices and agroforestry practices; students failed to differentiate between the two practices. They were able to develop their own opinion about the feasibility of sustainable agriculture and displayed critical thinking skills when forming their opinion. Several

students changed their previous opinion about sustainable agriculture after readings and class discussions. Those who kept their same opinion also gave logical reasons for doing so.

Objective 2: Assess students' perceptions of international agriculture

Students indicated that they have a fairly neutral view towards international agriculture, despite acknowledging that it has an impact on their lives. Based on their responses to the survey, it appears that students feel that international agriculture affects American agriculture. However, they do not feel that it affects them personally. It appears that international agriculture is not a relevant topic for students. This could explain their fairly neutral views.

Students lacked a desire to work overseas. They also indicated that they were not receptive to traveling to another country to learn about agricultural methods. This view contradicts other studies (Connors, 2004; Radhakrishna et al., 2003) about student attitudes towards studying abroad. Other factors such as age, background, previous exposure etc. must be taken into consideration before drawing conclusions about the discrepancy. Students were neutral in regards to the amount of international curricula currently being taught in their agricultural education class. However they were slightly more positive about teaching international agriculture in their class.

Objective 3: Determine the effectiveness of the curricula

Overall, students had a fairly positive opinion about the curricula. The curricula achieved the objective of increasing knowledge in international agriculture. Students indicated the biggest issue with the curricula was that the assignments were not challenging enough. This should be addressed when the curricula is revised. Students felt that they were able to participate in class and ask questions. This allows for exploration and could increase interest in the topic. In regards to the test questions, a majority of students agreed that they were taken directly from what was taught in class. This indicated that the test was a relevant component of curricula.

Recommendations

Based on the findings of this research project the following recommendations are offered. It is suggested that the development of international curricula for secondary students should be increased. This is supported by the recommendations of Radhakrishna et al., (2003), which stated that schools should continue their efforts to incorporate relevant international concepts into the curricula. Efforts should be made to ensure that all new curricula developed for secondary education has applicable international focus. This will help prepare students to enter a more globalized workforce, affording them a foundation of international concepts.

The curricula developed for the research project focused on Latin American agriculture. The United States is a major player on the world stage and interacts with countries from every region. Connors (2004) stated that students received little instruction at the post-secondary level regarding international agriculture. In order to compensate for this shortage of international agricultural lesson plans it is recommended that curricula should be developed for other regions of the world in addition to Latin America. In order to fully prepare students to enter the global economy, it is important that they are not limited to knowing just one region of the world. It is also recommended that lessons should be developed focusing on countries that the United States has particularly close dealings with (ex. China, Mexico). This would give students a more in-

depth understanding of these countries and their global positions. These lesson plans focusing on individual countries can be created as a component of the larger world region curricula.

The curriculum that was developed for the purpose of this research project should be revised based on observations and feedback from students. While the curriculum was successful in increasing students' knowledge in international agriculture, the test scores were below average (average being 70% or a "C" grade). The curricula should be revised by emphasizing components that students struggled to understand, making some assignments more challenging and incorporating more opportunities for feedback from the students. The test should be revised by rewriting questions that were unclear to students. The revision of the curricula should focus on increasing student comprehension of the subject matter while making the assignments more challenging.

It is also recommended that the revised curricula be taught and disseminated on broader scale. Only one high school class was used for the purpose of this study. Conclusions drawn from the study are limited due to the size of the study. The study was limited to a rural region in Florida. Different results may occur if the study is conducted in an urban setting or a different region of the state. Further research should be conducted using a larger sample size of high school students and different population demographics in order for the results to be more relevant and applicable on a broader scale.

If the United States is to compete in the global market it is important that we prepare our students to enter into the international workforce. This can be accomplished by incorporating a broader view of agricultural concepts into the curricula that gives students a foundation of international agriculture at the secondary level. More research is needed to understand student attitudes towards international agriculture. An international curriculum needs to be developed. The American Association for Agricultural Education and the Association for International Agricultural Education and Extension should play a lead role in this expansion of international agricultural education at the secondary level and provide opportunities for researchers to further explore this topic.

References

- Acker, D. G. (1999). Improving the quality of higher education in agriculture globally in the 21st century: Constraints and opportunities. *Proceeding of the 15th Annual Association of International Agricultural and Extension Education Conference*.
- Boyd, B. L., Felton, S. R., & Dooley, K. E. (2004). Providing virtual international experiences for undergraduates. *Journal of International Agricultural and Extension Education*, 11(3), 63-68.
- Connors, J. (2004). FFA Costa Rican travel seminar participants' international agriculture knowledge and perceptions. *Journal of International Agricultural and Extension Education*, 11(1), 71-79.

- Elliot, J., & Yanik, R. (2002). An analysis of secondary student attitudes and beliefs relative to international agricultural issues. *Proceeding of the 2002 Association of International Agricultural and Extension Education Conference*.
- Erikson, E. H. (1974). *Identity: Youth and crisis*. London, UK: Faber and Faber.
- Gibson, J., & Hillison, J. (2005). Developing a contemporary international agricultural course using experts. *Journal of International Agricultural and Extension Education*, 12(3), 91-94.
- Ibezim, D. O., & McCracken, J. D. (1994). Factors associated with internationalization of secondary level agriculture education programs. *Journal of Agricultural Education*, 35(3), 44-49.
- Klimstra, T. A., Hale, W. W., Raaijmakers, Q. A., Branje, S. J., & Meeus, W. H. (2010). Identity formation in adolescence: Change or stability? *Journal of Youth & Adolescence*, 39(2), 150-162.
- Manning, M. (1999). Developmentally responsive multicultural education for young **adolescents**. *Childhood Education*, 76(2), 82-7.
- Marcia, J. E. (1966). Development and validation of ego identity status. *Journal of Personality and Social Psychology*, 3, 551-558.
- Radhakrishna, R. B., Leite, F. C., & Domer, S. L. (2003). An analysis of high school students' attitudes and beliefs toward international agricultural concepts. [Abstract] *Journal of International Agricultural and Extension Education*. 10(2), 86.
- Steinberg, L. D. (2008) *Adolescence*. Boston, MA: McGraw-Hill Higher Education
- Tye, B. B., & Tye, K. A. (1992). *Global education: A study of school change*. Albany, New York: SUNY Press
- U.S. Census Bureau. (2009). *Educational Attainment in the United States: 2007*. Washington, DC: U.S. Department of Commerce Economics and Statistics Administration U.S. CENSUS BUREAU.
- Wingenbach, G., Boyd, B., Lindner, J. Dick, S., Arispe, S., & Haba, S. (2003). Students' knowledge and attitudes about international agricultural issues. *Journal of International Agricultural and Extension Education*, 10(3), 25-35.

Zhai, L., & Scheer, S. D., (2004). Global perspectives and attitudes towards cultural diversity among summer agriculture students at The Ohio State University. *Journal of Agricultural Education*, 45(2), 39-51.

The Interactions of Instructional Efficacy, Motivational Orientations, and Adult Characteristics on Tenure in the Florida Extension Master Gardener Program

Robert Strong

Assistant Professor, Texas A&M University

Amy Harder

Assistant Professor, University of Florida

Abstract

Master Gardeners serve Cooperative Extension as volunteer educators who deliver horticultural knowledge to citizens across Florida by teaching a broader amount of public constituents than can a single extension agent. The economic value of the Master Gardener participation to Florida Extension was nearly \$9,000,000 in 2009. Very little research has been conducted to determine what affects Master Gardener tenure. This study utilized self-efficacy theory and Houle's Typology on adult learning orientations as the overlapping framework to determine what predicts Master Gardener tenure. The research design was survey research, and stratified sampling was implemented to select the population of participants. A mail survey was employed as the data collection method, and the response rate received was 86.78%. Participant age, instructional efficacy, and specific learning orientations were found to significantly affect Master Gardener tenure. Instructional efficacy was the only variable that Master Gardener coordinators can enhance in participants in order to retain quality Master Gardeners. The continued participation from adults in the Master Gardener program improves the goals of Cooperative Extension. This study underscores the importance of preparing current and future Master Gardeners in teaching strategies.

Introduction

The *National Research Agenda* (Osborne, n.d.) stated research is needed to determine the reasons why individuals participate in agricultural extension education programs and to identify the professional competencies of change agents. Over 3,800 adults participate in the Florida Cooperative Extension Master Gardener Program. Master Gardeners (MGs) are volunteer educators serving as change-agents by delivering horticultural related subject matter to homeowners (Moravec, 2006). The interim Director of Florida Extension said the total value of Florida MG volunteer hours in 2009 were worth approximately \$8,600,000 to Florida Extension (M. Ferrer-Chancy, personal communication, June 11, 2010). In 2009, Florida MGs taught horticultural subject matter to over 64,000 adults (E. Eubanks, personal communication, June 9, 2010).

There are MG programs in 58 of the Florida's 67 counties. The requirements to develop into and continue certification as a Florida MG are rigorous. Adults apply and go through an interview process before being accepted to the Florida MG program. Individuals are notified if they are accepted to participate and then are required to pay \$100 for course materials. MGs meet once a week for a twelve week long course. At the end of the course, adults experience a graduation ceremony from the training. Upon program completion, adults are required to

contribute a minimum of 75 volunteer hours annually to the county program in order to continue certification as a Florida MG. MGs receive training from the MG coordinator throughout the year and their tenure in the program.

Teaching others how to solve problems is one of the primary reasons adults choose to volunteer (Corporation for National and Community Service, 2007). Adults are more likely to continue participation in Master Gardener when they are confident in their volunteer duties (Swackhamer & Kiernan, 2005). MGs teach the public gardening information through a variety of delivery methods. Using demonstrations or lectures for groups, answering individual telephone calls, identifying plants or plant diseases through face-to-face interaction, and responding to questions via social media outlets are some of the approaches that MGs utilize to teach the general public. It is important for Extension to prepare MGs accurately and proficiently as educators (Young, 2007).

Literature has identified reasons adults initially participate in MG. Wolford, Cox, and Culp III (2001) found adults primarily begin participating in MG in order to learn new information. Schrock (1999) found MGs participated for a desire to serve the community. Participants got involved with MG to gain a sense of belonging to a group (Rohs, Stribling, & Westerfield, 2002). However, literature has yet to identify what affects MG tenure. Strong and Harder (2010) suggested more rigorous research is needed to understand MG tenure.

Theoretical Framework

Bandura's (1993) self-efficacy theory and Houle's (1961) Typology were combined to construct the theoretical framework of this study. The combined theories were implemented to address the research objectives. Bandura (1993) said self-efficacy theory explains how individuals carry out tasks and respond to experiences shapes perceived self-efficacy. An adult's motivation to take part in an activity is affected by self-efficacy. Bandura (1997) suggested self-efficacy will impact how individuals think, form attitudes, motivate themselves, and work. Tschannen-Moran and Woolfolk Hoy (2001) indicated educator self-efficacy accounts for an instructor's confidence in teaching capacity to generate learner engagement and learning outcomes.

Bandura (1997) said individuals with high self-efficacy deal with difficult tasks for the opportunity to succeed. The potential of accomplishment stimulates relevance and draws in individuals to the activity. Elevated objectives and a vigorous dedication to goals are products of high self-efficacy individuals. High self-efficacy individuals put forth additional efforts to complete responsibilities in the midst of disappointments. Bandura (1993) indicated high self-efficacy adults are success oriented.

Low self-efficacy adults are more likely to discontinue participation during challenging ordeals. Additionally, low self-efficacy individuals may remain involved in an organization but steer clear of less efficacious responsibilities. Tschannen-Moran and Woolfolk Hoy (2001) suggested educators with low teaching efficacy create mediocre learning outcomes for participants in comparison to high teaching efficacy educators.

Houle's (1961) Typology was the other half of the theoretical framework implemented for this study. There are three adult learning orientations that make-up Houle's Typology.

Learning-oriented adults participate in an educational program primarily for the objective of learning new information. Activity-oriented adults are motivated to participate for the objective of creating a social relationship with others. Loneliness can lead an adult to a continued learning opportunity (Houle). Goal-oriented individuals are motivated primarily to accomplish a specific objective they, a current employer or agency has established. Educational programs will attract adults for different reasons and all three learning orientations but each individual participates for their respective ambitions. Houle said no particular orientation is better than another but adult educators should develop a comprehension of each learning orientation in order to best serve participant needs throughout the educational program.

Houle (1961) identified common characteristics of adults who participate in continued learning experiences. Adults with higher annual incomes participate in continued learning experiences than low income adults. Older adults are more likely to participate in educational programs than younger adults. Adults who have earned a higher education degree are more apt to participate in continued learning programs versus adults who have not. Regardless of demographic characteristics, the one attribute that all adults have in common is that they are all perpetual learners (Houle, 1961).

Purpose of the Study

The purpose of this study was to develop an understanding of adult participation in the Florida Master Gardener program. Specifically the objectives of the study were to:

1. Describe any existing relationships between efficacy in instructional strategies and motivational orientations for adults participating in Florida Master Gardener.
2. Understand the effects of demographics, efficacy in instructional strategies and motivational orientations on Florida Master Gardener tenure.

Methodology

The findings are part of a larger quantitative study conducted to develop an understanding of factors related to the enrollment and retention of Florida Master Gardeners. The research design was survey research. Stratified sampling was used to select the population of participants from the Florida Master Gardener program. The Florida MG program has approximately 3,822 participants.

A sample size of 362 usable surveys was required for a confidence interval of +/- 5 when $N = 3,822$ (Cochran, 1977). Bartlett, Kotrlik, and Higgins (2001) said response rates reported in recent literature are utilized to determine the potential response rate for future research involving a mail survey with a similar population. Babbie (2007) suggested 5 to 10 % be added to the total sample size for mail surveys in order to account for incorrect participant mailing addresses, participants who may have recently passed away, inaccurate mailing addresses and for questionnaires with incomplete participant responses. Previous research utilizing a mail survey with Master Gardeners produced response rates between 62% and 68% (Rexroad, 2003; Schott, 2001; Sutton, 2006). The sample size was 613 Master Gardener participants.

The questionnaire included three sections. Mergener's (1979) Education Participation Scale (M-EPS) highlighting adult learning orientations was the first section of the questionnaire.

The instructional efficacy construct from Tschannen-Moran and Woolfolk Hoy's (2001) Teacher Sense of Efficacy Scale (TSES) was the second section. Questions regarding participant demographics composed the third and final section of the questionnaire.

Mergener (1979) introduced his version of the Education Participation Scale consisting of forty-three items as a product of Houle's (1961) adult learning typology. Each component of the M-EPS contained more in-depth descriptions related to motivational orientations due to the depth of the scale. Mergener said the M-EPS was composed of six factors describing adult learning orientations: Competency-related Curiosity (Learning), Interpersonal Relations (Socialization), Community Service, Escape from Routine (Vary Routine), Professional Advancement (Professional Enhancement), and Compliance with External Influence (Other's Perceptions). Mergener's Education Participation Scale measured variables on a five-point scale: 1 = *very much influence*, 2 = *much influence*, 3 = *moderate influence*, 4 = *little influence*, 5 = *very little influence*.

The TSES was derived from Bandura's (1993) self-efficacy theory. The instructional efficacy construct of the TSES asked respondents seven items in regards to perceived teaching capacity ("How much can you do?") with a scale of: 9 = *a great deal*, 7 = *quite a bit*, 5 = *some influence*, 3 = *very little*, and 1 = *nothing* (Tschannen-Moran & Woolfolk Hoy, 2001). Gender, race, age, education, income, and length of residence in Florida were the demographic questions asked to respondents.

The researcher's pilot tested the questionnaire on a group of MGs in a county program in Tennessee. A team of researchers and MG coordinators from the University of Florida addressed content validity of the questionnaire. Reliability for the questionnaire was calculated *ex post facto* for the formal study at .94, and the pilot study .92.

The researchers utilized the methods outlined by Dillman, Smyth, and Christian (2009) to increase response rate from participants when instituting a mail questionnaire. The data collection instrument was printed in a booklet layout and then mailed to the sampled population. Six hundred thirteen participants were surveyed and 532 participants returned their completed surveys to the researchers. Thus, the response rate was 86.78%. Two respondent surveys were pulled from the study due to incomplete information. Early and late respondents were compared, and no significant difference existed. Therefore, the results can be generalized to the target population (Lindner, Murphy, & Briers, 2001).

Correlation coefficients were utilized to describe any existing relationships between efficacy in instructional strategies and motivational orientations for adults participating in Florida Master Gardener. Agresti and Finlay (2009) said correlation coefficients are calculated to represent the correlation. Pearson's *r* reveals the strength and direction of the association among two variables (Agresti & Finlay). Correlations define the association among variables as positive or negative. A value of $r = +.70$ or higher indicates a very strong association, $+.50$ to $+.69$ signifies a substantial positive association, $+.30$ to $+.49$ is a moderate positive association, $+.10$ to $+.29$ suggests a low positive association, $+.01$ to $+.09$ implies a negligible positive association, $.00$ means no association exists, $-.01$ to $-.09$ indicates a negligible negative association, $-.10$ to $-.29$ denotes a low negative association, $-.30$ to $-.49$ represents a moderate

negative association, -.50 to -.69 suggests a substantial negative association, and -.70 or lower indicates a very strong negative association (Davis, 1971).

Poisson regression was employed to measure the dependent variable's (Florida Master Gardener tenure) relationship to explanatory variables (demographic characteristics, instructional efficacy, and motivational orientations). Poisson regression models are employed to predict data counts such as number of germinated corn seed, number of hatched eggs, etc. (Agresti & Finlay, 2009). In this study, tenure (total number of years as a MG) was treated as count data because it has not been established that MGs with longer tenure rank higher in terms of volunteer value than MGs with shorter tenure. $\text{Log}_e(Y) = \beta_0 + \beta_1X_1 + \beta_2X_2 + \dots + \beta_nX_n$ is a Poisson regression model coefficient. McCullagh and Nelder (1983) suggested the Poisson regression model assists the researcher by articulating the log outcome rate as a linear function of a set of predictors. The researchers utilized model Chi-Square and Deviance statistics, as outlined by Mittlböck and Waldhör (2000), for the model fit for the Poisson regression analysis.

A limitation of the study is the selection of Master Gardener adult participants in Florida. The target population may not be characteristic of other Master Gardener programs in other states. In this study, women accounted for 73.01% ($n = 387$) of the responses and whites accounted for 92.07% ($n = 488$) of the responses. The majority ($n = 421$, 79.43%) of respondents were 56 years old or older. Seventy percent of respondents ($n = 421$) were 56 years old or older. A large percentage of respondents had obtained some form of higher education. Seventy-nine percent ($n = 415$) of respondents had earned at least an Associate's Degree. Most respondents earned between \$24,999 and \$99,999 annually. Adults indicating their annual income was between \$24,999 and \$99,999 annually accounted for 61.32% ($n = 325$) of the responses. The vast majority (75.84%, $n = 402$) of the respondents had lived in Florida for at least eleven years. Of those respondents, nearly 40% had lived in Florida for 31 years or more.

Findings

The study's first objective was to describe any existing relationships between respondents' efficacy in instructional strategies and the following motivational orientations: (a) Learning, (b) Community Service, (c) Socialization, (d) Vary Routine, (e) Other's Perceptions, and (f) Professional Enhancement.

Learning and Instructional Efficacy exhibited a significant low positive relationship, $r(525) = .23, p < .05$ (see Table 1). A significant low positive association existed between Community Service and Instructional Efficacy, $r(525) = .25, p < .05$. Socialization and Instructional Efficacy exhibited a significant negligible positive association, $r(525) = .09, p < .05$. No other significant relationships existed.

Table 1

Relationships between Motivational Orientations and Instructional Efficacy (N = 530)

Motivational Orientations	Instructional Efficacy		
	<i>r</i>	<i>p</i>	Magnitude
Community Service	.25	.00**	Low
Learning	.23	.00**	Low
Socialization	.09	.03*	Negligible
Professional Enhancement	.01	.87	Negligible
Other's Perceptions	.01	.90	Negligible
Vary Routine	.00	.93	Negligible

Note. Magnitude: $.01 \geq r \geq .09$ = Negligible, $.10 \geq r \geq .29$ = Low, $.30 \geq r \geq .49$ = Moderate, $.50 \geq r \geq .69$ = Substantial, $r \geq .70$ = Very Strong.

* $p < .05$, ** $p < .01$.

The second objective was to understand the effects of the combined attributes of demographic characteristics, motivational orientations, and efficacy in instructional strategies on Master Gardener tenure. Sixty-five respondents did not identify their level of income. Therefore, $N = 465$ (total number of respondents identifying personal income level) was used in the Poisson regression analysis. Poisson regression was used to assess the net effect of each measure of demographic characteristics, motivational orientations, and instructional efficacy on MG tenure. The Poisson regression model was significant and indicated a good fit, with $\chi^2(1, N = 465) = 4.96, p < .01$.

A Poisson regression model coefficient is illustrated as: $\log_e(Y) = \beta_0 + \beta_1X_1 + \beta_2X_2 + \dots + \beta_nX_n$. Age was the only demographic characteristic that proved significant ($p < .01$). As age increased one unit, the \log_e of Master Gardener tenure increased .23. Instructional efficacy was significant ($p < .01$) on MG tenure as well (see Table 2). As instructional efficacy increased one unit, the \log_e of Master Gardener tenure increased .12.

Socialization, Vary Routine, and Other's Perceptions were the motivational orientations found to be significant ($p < .01$) on MG tenure. Learning was found to be significant ($p < .05$) on MG tenure. However as Learning and Socialization increased, MG tenure decreased. As Learning increased one unit, the \log_e of Master Gardener tenure decreased -.10. When Socialization increased one unit, the \log_e of Master Gardener tenure decreased -.10. As Vary Routine increased one unit, the \log_e of Master Gardener tenure increased .09. As Others' Perceptions increased one unit, the \log_e of Master Gardener tenure increased .14. The Poisson regression model for this study was illustrated as: Master Gardner tenure = $.16 + .23 \text{ Age} + .12 \text{ Instructional Efficacy} + (-.10) \text{ Learning} + (-.10) \text{ Socialization} + .09 \text{ Vary Routine} + .14 \text{ Others' Perceptions}$.

Table 2

Summary of Poisson Regression Analysis of Demographic Characteristics, Instructional Efficacy, and Motivational Orientations on Florida Master Gardener Tenure

	<i>N</i>	<i>B</i>	<i>SE B</i>	<i>P</i>
Intercept	465	.16	.21	
Age	465	.23	.03	.00**
Instructional Efficacy	465	.12	.02	.00**
Socialization	465	-.10	.03	.00**
Vary Routine	465	.09	.03	.00**
Other's Perceptions	465	.14	.03	.00**
Learning	465	-.10	.04	.01*

Note. ** $p < .01$, * $p < .05$.

The researchers tested for interactions among demographic characteristics, motivational orientations, and instructional efficacy in the Poisson model. Age was identified as the sole demographic characteristic that produced a significant interaction ($p < .05$) with other items. The model provided further support that respondents were more likely to continue participating in MG when they possessed instructional efficacy. There was a significant interaction ($p < .01$) with age and instructional efficacy on MG tenure. The \log_e of MG tenure increased .03 as the expected \log_e count for each unit of instructional efficacy and age increased.

Certain motivational orientations produced significant interactions with age ($p < .01$). When Other's Perceptions and age increased, a \log_e of MG tenure increased .03. As one unit of Community Service and age increased, a \log_e of MG tenure decreased -.02. Vary Routine and age produced a significant interaction ($p < .05$) as well. As each unit of Vary Routine and age increased, a \log_e of MG tenure increased .02 (see Table 3).

Table 3

Results of Interactions between Instructional Efficacy, Motivational Orientations, and Age on Florida Master Gardener Tenure

	<i>N</i>	<i>B</i>	<i>SE B</i>	<i>P</i>
Instructional Efficacy x Age	465	.03	.00	.00**
Other's Perceptions x Age	465	.03	.01	.00**
Community Service x Age	465	-.02	.01	.00**
Vary Routine x Age	465	.02	.01	.01*

Note. ** $p < .01$, * $p < .05$.

Conclusions

The study's first objective was to describe any existing relationships between efficacy in instructional strategies and motivational orientations for adults participating in the MG program. Respondents' instructional efficacy was positively correlated with their Learning, Community Service, and Socialization motivational orientations. Learning represented Houle's (1961) learning-oriented classification. The Community Service motivation represented Houle's goal-oriented classification. Socialization describes Houle's activity-oriented classification. There

were no significant associations with Vary Routine, Other's Perceptions and Professional Enhancement between Instructional Efficacy.

The study's second objective was to understand effects of the combined attributes of demographics, efficacy in instructional strategies and motivation orientations on MG tenure. Based upon Houle's (1961) work, the researchers believed gender, age, race, education, and income would have been significant in determining a portion of MG tenure. Age was the sole demographic characteristic that was significantly associated with MG tenure. Instructional efficacy and the motivational orientations of Learning, Socialization, Vary Routine, and Others' Perceptions were significantly associated with MG tenure.

Age, motivational orientations, and instructional efficacy were tested for significant interactions. This study indicated a significant ($p < .05$) interaction of participant age and level of instructional efficacy predicted adults' tenure in the MG program. A significant ($p < .05$) interaction of participant age and the motivational orientations of Community Service and Others' Perceptions predicted adults' tenure in MG. Relationships did exist between instructional efficacy and motivational orientations, but not for every orientation. Some were positive relationships and some were negative relationships.

Implications

Houle (1961) said older adults are more likely to participate in continued learning experiences than younger adults. As this study revealed, age was the lone significant demographic characteristic that affected MG tenure. The vast majority of respondents (70%, $n = 421$) were 56 years old or over. Older adults may be more willing and able to participate in MG to serve their community and search out a diverse routine in their daily lives.

This study found MG tenure increased as instructional efficacy of MGs increased. Bandura (1997) said individuals will continue pursuing interests when they feel confident in their abilities to achieve the goals associated with those interests. The job description for Florida MGs is to teach horticultural information to local citizens. Tschannen-Moran and Woolfolk Hoy (2001) indicated high instructional efficacy educators achieve higher learning outcomes than low instructional efficacy educators.

Significant ($p < .05$) interactions were revealed among age and instructional efficacy and Community Service, Vary Routine and Other's Perceptions on MG tenure. Adults demonstrating Community Service, Vary routine, and Other's Perceptions orientations are likely to be drawn to the MG program because participants' ages and the roles those individuals have as volunteer educators in local communities. Individuals will continue pursuing appealing activities when they believe they can achieve the objectives of those pursuits (Bandura, 1997) and older adults are more apt to participate in educational programs to break their routine and learn how to serve others (Houle, 1961).

Houle (1961) said adults continue participating in learning experiences for different reasons than they became initially involved. There was a negative relationship with motivational orientations Learning and Socialization on MG tenure. Learning produced a negative \log_e on MG tenure because adults may have believed they had acquired as much knowledge as they could and discontinued their involvement in the program. Socialization produced a negative \log_e

on MG tenure because adults may have felt they had exhausted their social circle within the program and terminated their service. When adults believe an educational program has accomplished their objectives, they discontinue their participation (Houle, 1961).

Recommendations

The variables presented in this study provided researchers, state and local coordinators information on Florida MG tenure. Other state MG programs should seek to understand effects of the combined attributes of demographics, motivation orientations and efficacy in instructional strategies on MG tenure. This information would be beneficial to national MG program coordinators in determining MG tenure and assist Cooperative Extension systems in retaining volunteer educators (Swackhamer & Kiernan, 2005). Future research should study adults who have terminated involvement in MG to understand reasons associated with turnover.

The findings from objective one uncovered other facets that increase instructional efficacy. Providing MGs opportunities to teach citizens in instructional teams would address participant motivational orientations (Learning, Community Service and Socialization) and jointly enhance instructional efficacy. This recommendation should assist practitioners to offer experiences that motivate adults to continue with volunteer responsibilities and reduce turnover (Corporation for National and Community Service, 2007). Local coordinators and the state director can focus program promotional material, and the lessons they utilize to train and prepare adults on opportunities to learn, serving the community, and developing social relationships.

Results from objective two revealed numerous recommendations practitioners can improve Florida MG tenure. Instructional efficacy is a competency needed by MGs as change agents due to instructional efficacy predicted Florida MG tenure. In addition to learning horticultural content during the initial twelve week training program, participants studying to become MGs should be taught active teaching and learning techniques for adult learners. Teachers who have robust confidence in teaching efficacy create opportunities for learners to master the subject matter (Bandura, 1993). Seasoned MGs should be provided professional development teaching experiences designed to improve individual's instructional efficacy and clientele's learning outcomes. The findings from this study's second objective reinforce previous recommendations per Strong and Harder (2010) for practitioners to provide training in instructional strategies for current and future MG volunteers.

The findings from objective two provide practitioners a clear-cut description of what motivates adults to participate in the program (Young, 2007). Learning, Socialization, Vary Routine, and Others' Perceptions motivational orientations were significantly related to MG tenure. The state and local coordinators should ensure the Florida MG program addresses these needs through instruction and opportunities presented participants as volunteer educators. Addressing participant needs will positively affect their continued participation (Houle, 1961).

Older adults may participate in MG due to the time requirement (minimum 75 hours annually) to serve as a volunteer educator. MG coordinators should continually strive to market MG to adults of all ages in order to broaden the potential of including participants with diverse backgrounds in the program. Spouses that are homemakers or unemployed may provide practitioners more volunteer educators (Master Gardeners) given the time requirement. Adults too disabled for employment may offer coordinators more sources as volunteer educators.

Alternatively, Florida Extension may consider reducing the number of required volunteer hours per year in order to attract more participants.

The economic value and clientele contacts that MGs provided Florida Extension in 2009 were enormous. However, this study provided insight into some ways to improve MG tenure and develop a competency needed by MGs as change agents. This study found preparing MGs to be better volunteer educators will enhance the likelihood adults will remain in the program and serve as high quality volunteer educators. Cooperative Extension will reap the benefits of prolonged high quality MG participation through the production of increased learning outcomes in clientele.

References

- Agresti, A., & Finlay, B. (2009). *Statistical methods for the social sciences* (4th ed.). Upper Saddle River, NJ: Prentice Hall.
- Babbie, E. (2007). *The practice of social research* (11th ed.). Belmont, CA: Wadsworth.
- Bandura, A. (1997). *Self-efficacy: The exercise of control*. New York, NY: W. H. Freeman and Company.
- Bandura, A. (1993). Perceived self-efficacy in cognitive development and functioning. *Educational Psychologist, 28*(2), 117-148.
- Bartlett II, J. E., Kotrlik, J. W., & Higgins, C. C. (2001). Organizational research: Determining appropriate sample size in survey research. *Information Technology, Learning and Performance Journal, 19*(1), 43-50.
- Cochran, W. G. (1977). *Sampling techniques* (3rd ed.). New York, NY: John Wiley & Sons.
- Corporation for National and Community Service (2007). *Strategic plan 2006-2010*. Publication CNS0506.
- Davis, J. (1971). *Elementary survey analysis*. Englewood Cliffs, NJ: Prentice Hall.
- Dillman, D. A., Smyth, J. D., & Christian, L. M. (2009). *Internet, mail and mixed-mode surveys: The Tailored Design Method* (3rd ed.). New York, NY: John Wiley & Sons.
- Houle, C. O. (1961). *The inquiring mind*. Madison, WI: University of Wisconsin Press.
- Lindner, J. R., Murphy, T. H., & Briers, G. E. (2001). Handling nonresponse in social science research. *Journal of Agricultural Education, 42*(4), 43-53. doi: 10.5032/jae.2001.04043
- McCullagh, P., & Nelder, J. A. (1983). *Generalized Linear Models*. London, England: Chapman and Hall, Inc.

- Mergener, M. A. (1979). The motivational orientations of pharmacists toward continuing education. *Dissertation Abstracts International*, 39(08), 3775B. (UMI No. 7820638)
- Mittlböck & M., & Waldhör, T. (2000). Adjustment for R²-measures for Poisson regression models. *Computation Statistics and Data Analysis*, 34, 461-472.
- Moravec, C. (2006). Continuing education interests of Master Gardener volunteers: Beyond basic training. *Journal of Extension*, 44(6) Article 6RIB5. Retrieved from <http://www.joe.org/joe/2006december/rb5.php>
- Osborne, E. W. (Ed.) (n.d.). *National research agenda: Agricultural education and communication, 2007-2010*. Gainesville, FL: University of Florida, Department of Agricultural Education and Communication.
- Rexroad, T. D. (2003). Evaluation of marketing methods used to promote extension programs as perceived by Master Gardeners in West Virginia. *Manuscript Abstract International*, 41(04), (UMI No. 1409750)
- Rohs, F. R., Stribilng, J. H., & Westerfield, R. R. (2002). What personally attracts volunteers to the Master Gardener Program? *Journal of Extension*, 40(4). Retrieved July 13, 2008 from <http://www.joe.org/joe/2002august/rb5.shtml>
- Schott, N. J. (2001). Volunteer motivation and satisfaction associated with the University of Illinois Extension Master Gardener program. *Dissertation Abstracts International*, 61(10), 3847A. (UMI No. 9990131)
- Schrock, D. S. (1999). A functional approach to understanding and assessing the motivation and retention of university extension Master Gardener volunteers. *Dissertation Abstracts International*, 59(12), 6508B. (UMI No. 9913378)
- Strong, R., & Harder, A. (2010). Master Gardener's teaching efficacy and demographic characteristics as volunteer educators for Cooperative Extension. *Journal of Southern Agricultural Education Research*, 60, 14-24.
- Sutton, E. A. (2006). An evaluation of the Master Gardener Program in Arkansas. *Dissertations Abstracts International*, 44(05). (UMI. 15456).
- Swackhamer, E., & Kiernan, N. E. (2005). A multipurpose evaluation strategy for Master Gardener Training Programs. *Journal of Extension*, 43(6). Retrieved from, <http://www.joe.org/joe/2005december/a4.php>
- Tschannen-Moran, M., & Woolfolk Hoy, A. (2001). Teacher efficacy: Capturing an elusive construct. *Teaching and Teacher Education*, 17, 783-805.
- Wolford, M., Cox, K. & Culp III, K. (2001). Effective motivators for master volunteer program development. *Journal of Extension*, 39(2). Retrieved July 13, 2008, from <http://www.joe.org/joe/2001april/rb4.html>

Young, L. (2007). Re-designing a Master Gardener training program to meet the changing needs of volunteers and Cooperative Extension. *Journal of Extension*, 45(5) Article 5IAW2.
Retrieved from, <http://www.joe.org/joe/2007october/iw2.php>

A Balancing Act: Investigating Graduate Student and Advisor Relationships in Agricultural Leadership, Education, Extension, and Communications

Bart E. Gill, Mark Russell, John Rayfield, Texas A&M University

Abstract

The connection between an advisor and advisee is dependent on many factors. Graduate students depend on their advisors to assist them in accomplishing their career goals and ambitions. According to the mentoring-empowered model, as proposed by Selke and Wong (1993), the roles that an advisor plays are as follows: teacher, sponsor and socializer, counselor, role model, and encourager. This study sought to determine the perceptions of agricultural education graduate students in regard to their advisors' performance in the following areas: degree planning, student interests, advisor knowledge, and support. Overall agricultural education graduate students (N = 274) are satisfied with their advisor performance and support. Agricultural education graduate advisors are knowledgeable in the areas of: 1) research; 2) university and departmental policies and procedures; 3) funding opportunities; and 4) available coursework. Agricultural education advisors are student-oriented and care about their students' well-being, both academically and personally.

Introduction

The strength of the advisor/advisee relationship has long been a determining factor in the success for students enrolled in graduate school. The connection between advisor and advisee is dependent on many factors. As in most successful relationships, both parties have obligations and responsibilities to fulfill in an effort to determine success on both ends of the affiliation. Wrench and Punyanunt (2004) cite Bell's (2000) article, defining mentor, as "someone who helps someone else learn something that he or she would have learned less well, more slowly, or not at all if left alone" (p.53). Wrench and Punyanunt (2004), go on to describe more roles of the advisor. One of which, is helping their students prepare for being an academic professional. Among other aspects, this is accomplished by helping their students learn about research, offering the student opportunities to collaborate on research and grant ideas, serving as a guide throughout the thesis or dissertation process, allowing for teaching and advising opportunities, determining the class schedule that is most suitable for the student, and allowing for participation or input during faculty meetings and retreats.

The success of the relationship between advisors and advisees is a crucial element for determining the overall success of a graduate program. While there are many factors associated with success of a program, there are underlying issues from the standpoint of both the advisor and advisee. In fact, a positive relationship between the two can often lead to greater motivation that can ultimately lead to better and more successful career decisions. Zhao, Golde, and McCormick (2005) state that the impact and success of the advising relationship can last beyond the years of graduate school for the graduate student. For example, the strength of an advisor's letter of recommendation following graduate school can affect future career options for the student. On the other hand, a negative relationship can lead to harsher and quicker decisions that can consequently allow for harmful career choices.

Althaus (1997); Gorham and Millette (1997); and Scott and Rockwell (1997). state that little research has been done examining the advisor/advisee relationship. Additionally, most of the research that has been done, examined undergraduate student relationships with their advisors, rather than graduate student relationships. Mounting frustration with a graduate program can encourage the graduate student to leave the program prematurely and have dissatisfaction with their advisor. Lovitts and Nelson (2000) affirm that graduate students who complete their degrees are twice as likely to express satisfaction with their graduate advisor. Additionally, a high grade point average during their undergraduate career does not necessarily mean that the student will succeed in graduate school. In fact, students who leave and those who stay are equally qualified.

The Issues/Problems

As with any professional relationship, just as there are positive attributes, there are also instances where problems and issues can arise. The graduate student/advisor relationship is no exception. In the graduate student/advisor relationship, there is often a lack of meaningful contact to clear up confusion for the graduate student. Many professors are forced to maintain research projects to further their careers, therefore are unable to commit to time consuming mentor relationship with the graduate student. Additionally, some of the breakdowns in dialogue could be the direct result of the personalities involved (Repak, n.d.). In many cases, graduate students are aware of the high demands of being a University graduate advisor and may feel as though the advisor has more pressing issues than those that the graduate student possess. Adding to the issues of lack of time and increased work responsibility is the lack of guidance for those graduate students that also serve as teaching assistants. Most universities offer little or no training for those students who serve as teaching assistants. The stress of standing in front of a class can be difficult for an inexperienced graduate student and can add to the heavy stress already associated with being a graduate student. Compounded with grading tests, preparing lessons, and making decisions of an instructor, the workload can become weighted down quickly (Repak, n.d.). Often graduate students also feel a certain degree of uncertainty over expectations from the advisor, causing poor relationship within the department. A direct effect of uncertainty can cause the graduate student to spend more time in the graduate program. Girves and Wimmerus (1988) state "It is certain that a student's commitment to earning a degree in a particular discipline is continually modified by his or her experiences in that department. What the faculty do to stimulate the student's interest and to strengthen the student's commitment may ultimately determine the level of degree progress achieved by students in that department" (p. 186).

Advisor/Advisee Relationships

Whether it is a negative or positive effect, the effect an advisor has on an advisee can be a life changing experience. A great advisor can instill a positive work ethic, good teaching, a solid research base, and overall drive to a successful professional career. On the other hand, a poor advisor can offer the opposite effect; not only on the academic life of a graduate student, but also the personal life as well. In one instance at Harvard University, a chemistry student committed suicide as result of the intense pressure of graduate school. In the suicide note, the student

blamed his advisor (Wrench & Punyanunt, 2004). To build positive advising relationships between advisors and advisees, results from Schlosser, Knox, Moskovitz, and Hill's (2002) study show that not all graduate students enjoy a mentoring type of advising relationship with their advisor. Further, to build positive advising relationships, "both student and advisor must be thoughtful and purposeful about the formation and maintenance of their relationship, paying attention to each person's expectations and goals" (p. 186). On the other hand, graduate students who are unsatisfied with their advising relationships are less likely to refer their advisors as mentors to other or potential graduate students. Instead, they may "report negative mentoring behaviors" (p. 186) as demonstrated in their study. Further, a positive advisor/advisee relationship can be described as a relationship, in which each has a good rapport, can process conflict open, and work together to facilitate the advisee's progress through the graduate program (Schlosser et al., 2002).

Advisees as Students

Schlosser et al. (2002) study reported that students who are allowed to choose their advisor are typically more satisfied with their advisor. Allowing students the option of choosing their advisor gives the feeling of empowerment and a feeling of control in their graduate program. Conversely, students who were assigned an advisor are typically less satisfied with their advisor. Thus, the "simple procedure of allowing students to choose an advisor may facilitate the development of positive and successful advising relationship" (p.186). Not having the option of choosing an advisor prior to beginning their graduate program allows for very little feeling of empowerment. However, being given the choice and opportunity to change advisors during their graduate program can allow for a graduate student to enhance the overall satisfaction level experienced while in their graduate program (Schlosser et al., 2002).

Most researchers recommend that graduate students make efforts to define the expectations from their advisor at the inception of their graduate program. In fact, Repak (n.d.) states that the graduate student should determine the style and personality of the department they are working in. Graduate students should be prepared to function with open dialogue and be prepared to communicate in a more informal atmosphere or use more restraint if necessary when getting to know major professors. Depending on the climate of the department, the graduate student can alter his or her communication skills to determine the expectations of the department. Prior to beginning graduate school, the incoming graduate student should spend time learning the culture of the department before the semester begins. Or, at the least, in the beginning weeks of the semester, the graduate student should make efforts to determine the methods of which the professors and graduate students intermingle with each other. Lovitts and Nelson (2000) determined in their study that students who do not finish their graduate degree often leave with a sense of personal failure. More so, many of the students cannot see how the culture of the department influenced their departure from their department. Consequently, the student is as equally likely to blame himself as they are the departmental environment. The lasting effect is the long-term effect a departure can have on a student. Graduate students who departed felt "disappointed," "depressed," or "shaken up" after leaving. These same students, who often had as much as four years of graduate education, often took jobs in the blue-collar sector of the labor market simply due to the perception of not feeling wanted or needed in a department. In a (Powell, 1998) Harvard University study, researchers found that several graduate students felt as though it was important that their advisor's respect them and wanted to feel as though they could

talk to their advisor openly. Further, many graduate students expressed frustration that the criteria to which they are being evaluated and the guidelines for completing their degree requirements are not made clear to them at any time during their tenure as graduate student (Powell, 1998).

Advisors as Mentors

In a (Powell, 1998) study conducted at Harvard University, faculty stated that it is extremely important to keep in touch with their advisees, but it can vary from student to student as to how interaction is necessary. While some students are fine if the check in infrequently, others require much more frequent contact, even monthly contact. Furthermore, email was noted by the faculty as being the ideal method of contact between faculty and graduate student. However, there is no substitute for face-to-face contact (Powell, 1998). Additionally, teaching, ethics, the academic setting, and other crucial aspects of becoming an academic professional are also duties of the graduate advisor. In their study, Lovitts and Nelson (2000) concluded that the single most contributing factor to graduate student retention was directly related to the relationship with the faculty advisor. Moreover, a faculty member who is concerned about the well being of their student is the best person to assess the graduate student's progress and reinforce self worth. Advisors should make clear their expectations prior to the student's graduate career beginning. Not having said discussion can potentially cause later disappointment from the advisor and advisee (Schlosser et al., 2002). Advisors should also make it a point to make themselves available to their advisees on a "as needed" basis. Frequent contact with the advisor and the feeling of advisor accessibility is a simple, yet powerful tool in contributing to satisfaction with the advising relationship (Schlosser et al., 2002). Zhao et al. (2005) list several positive characteristics advisors possess that attribute to advisees choosing them as their graduate advisors. Beginning with reputation, is the advisor known for being a good teacher, researcher, and advisor? Is there intellectual compatibility? Meaning is there alignment of interests and methodological expertise. What are the pragmatic benefits? Can the advisor help in providing financial support and a favorable work environment for the advisee?

Zhao et al., (2005) cite the following characteristics as a good advisor: Supportiveness (Long, 1987), high levels of interaction (Gerholm, 1990; Girves & Wemmerus, 1988; Hartnett, 1976; Weiss, 1981), purposefully assisting the student progress in a timely manner (Heiss, 1970; Lovitts, 2001; Rudd, 1986), providing regular reviews of progress (Harnett, 1976; Heiss, 1970), and treating the student as a junior colleague (Girves & Wemmerus, 1988). Zhao et al. (2005), go on to point out that even with this vast amount of knowledge of certain qualities of a good advisor, there is still a lack of information about "how advisor behaviors are related to satisfaction with the advising relationship" (p.3).

Conceptual Framework

The mentoring-empowered model (see Figure 1.1), as proposed by Selke and Wong (1993) will serve as the conceptual framework for this study. The mentoring-empowered model defines the roles that advisors play. At the center of this model is the principle that advisors should act as nurturers in the advising process. According to Selke and Wong (1993), the five roles that a successful advisor must play are: teacher, encourager, role model, counselor, and sponsor-socializer.

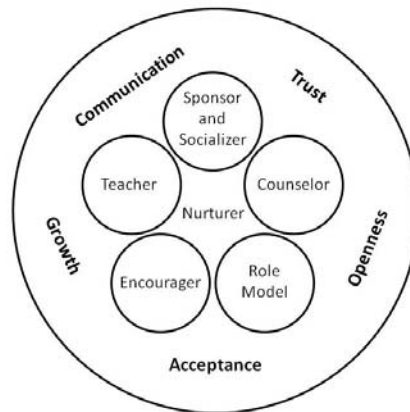

Figure 1.1. Mentoring-Empowered Model (Selke & Wong, 1993)

The mentoring-empowered model was chosen as the conceptual model for this study as it encompasses various roles and factors that define a successful graduate advisor. According to Selke and Wong (1993), “academic advisement models have traditionally focused upon the needs of undergraduate students” (p. 2). Due to the characteristics of graduate students, the advisement needs of graduate students are different than those of the undergraduate counterparts. The mentoring-empowered model “focuses upon the psychological and developmental needs inherent to adult graduate students” (p.2) and therefore relates closely to the purpose of this study.

Purpose and Objectives

This study addresses research priority area of Agricultural Education in University and Postsecondary Settings found in the National Research Agenda. Particularly, this study address RPA 3: Enhance the effectiveness of agricultural and life sciences faculty. The purpose of this study was to determine the perceptions that agricultural education graduate students have in regards to their advisors’ performance in the following areas: degree planning, student interests, advisor knowledge, and support. The following research objectives were used:

1. To describe graduate students’ perceptions of their satisfaction in regards to degree planning assistance provided by their advisor.
2. To describe graduate students’ perceptions of their advisor’s support in regards to the graduate student’s personal interests.
3. To describe graduate students’ perceptions of their advisor’s ability to help graduate students improve their knowledge in relation to research and their focus area.

Methods and Procedures

This study was descriptive in nature. Graduate program coordinators at four year institutions, which possess graduate degree programs within agricultural education (teacher education, communications, extension, and/or leadership) were initially contacted about participating in the study. The researchers contacted graduate coordinators up to a maximum of

four times, via email, in an attempt to enlist their assistance. Graduate coordinators that did not respond after four email contacts were contacted either by telephone or through face to face communication, in an attempt to enlist their assistance. If contact was not made with the graduate coordinator via telephone or face to face, then the graduate coordinator's institution was removed from the participant list. Graduate coordinators, who agreed to participate, assisted in the distribution of the questionnaire. A web-based questionnaire was sent to graduate coordinators, along with a recruitment letter, to be distributed to agricultural education graduate students enrolled at all of the institutions who agreed to participate. After distributing the questionnaire and recruitment letter, graduate coordinators were asked to report the total number of graduate students, which had been included on their graduate student enrollment list. Graduate coordinators were contacted up to three times reminding them to distribute the questionnaire and to report the total number of graduate students in their program. Institutions who did not report the total number of graduate students were removed from the participant list and no further contact was made. Following this process, a total of 26 institutions participated in the study and the questionnaire was sent to 968 graduate students.

After a thorough review of the literature, a 33 question instrument was developed. The instrument consisted of four constructs: degree planning, student interests, advisor knowledge, and support. Each construct consisted of five to twelve questions with a total number of questions equally 33. All constructs consisted of Likert type questions: 0 = Not Applicable; 1 = Strongly Disagree; 2 = Disagree; 3 = Agree; and 4 = Strongly Disagree, or multiple choice questions. An expert panel familiar with graduate student – advisor relationships reviewed the questionnaire to establish content and face validity. A pilot test was conducted to establish reliability; $\alpha = .96$. The pilot test was distributed to all members of the Graduate Student Council at a southern university. Frequencies and percentages were reported.

Participants were contacted four times following the guidelines of Dillman, Smyth, and Christian (2009). Each point of contact consisted of an email, containing the link to the web-based questionnaire, being sent to the graduate coordinator at each of the participating institutions. Some of the institutions informed the researcher that they had distributed the questionnaire and others failed to do so. A response rate of 28.3% was achieved. Early and late responders were compared using an independent samples *t*-test to control for non-response error and no significant differences were found (Lindner, Murphy, & Briers, 2001).

Data were analyzed using the Statistical Package for the Social Sciences (SPSS 17.0) and frequencies and percentages were obtained. Frequencies and percentages were used to describe responses to scale items.

Findings and Results

A total of 274 graduate students participated in this study. This group of graduate students consisted of 62.2% females with males comprising 37.8% of the population. Eighty-six percent were white, 3.9 % were Hispanic, 3.1% were African-American, and 2.8% were Asian. Nearly two-thirds (66.5%) of the respondents were between the ages of 22 and 30. Almost half (48.4%) classified themselves as Master of Science students and 19.7 % reported they were Ph.D. seeking students. A majority (65.7%) described themselves as on-campus students, while

34.3% reported being distance education students. Similarly, 61.8% were classified as full-time students and 38.2% classified themselves as part-time students.

When reporting the number of graduate credits earned, 33.5% had earned between zero and nine hours, 15.7% had earned 10-18 hours of graduate credit, 21.7% had completed 19-30 hours of credit, and 29.1% had earned more than 31 graduate credits. A vast majority (94.9%) were affiliated with the College of Agriculture at their institution. Nearly a third (29.9%) reported their focus area to be teacher education, followed by 25.2% reporting Extension Education as their focus. Agricultural Leadership accounted for 15.7% of the respondents and Agricultural Communications majors made up 9.8% of those who responded.

The graduate students in the study were also asked to provide demographic information on their advisors. Approximately one-fourth (27.8%) reported their advisor was female with 72.2% having a male advisor. A large percentage (91.7%) stated their advisor was white, 4% were African American, and 3.2% had a Hispanic advisor. Graduate students were asked to estimate their advisor's age. Thirty-four percent estimated their advisor's age to be between 30-39 years. An additional 28.6% reported their advisor's age to be between the ages of 40 and 49 and 26.6% believed their advisor was between the ages of 50 and 59. Only 7.9% thought their advisor was over 60 years old. The final demographic characteristic reported by graduate students was their advisor's professorial level. Only 21.4% stated their advisor was an assistant professor, 38.1% of the graduate student's advisors were associate professors, and 40.5% of the graduate advisors were at the professor level.

Table 1 contains information about the satisfaction of graduate students in regard to their advisor's assistance in the area of degree planning. The results show that 52.7% of the participants strongly agree and 31.9% agree that they are satisfied with the support that their advisors are providing to them in the area of degree planning. A majority of the graduate students strongly agree (63.7%) or agree (30.8%) that their advisors encourage them to be actively involved in the degree planning process. According to the participants, their advisors recommend courses that will assist them in achieving both professional (strongly agree = 53.1%; agree = 38.5%) and personal goals (strongly agree = 49.1%; agree = 37.7%).

Table 1

Graduate Student Satisfaction with Degree Planning (N = 273)

Satisfaction with degree planning	Strongly Disagree		Disagree		Agree		Strongly Agree	
	<i>f</i>	%	<i>f</i>	%	<i>f</i>	%	<i>f</i>	%
My advisor clearly defines my degree requirements	2	.7	28	10.3	113	41.4	130	47.6

(continued)

Satisfaction with degree planning	Strongly Disagree		Disagree		Agree		Strongly Agree	
	<i>f</i>	%	<i>f</i>	%	<i>f</i>	%	<i>f</i>	%
My advisor recommends courses that may help me achieve my professional goals	1	.4	22	8.1	105	38.5	145	53.1
My advisor recommends courses that may help me achieve my personal goals	3	1.1	33	12.1	103	37.7	134	49.1
My advisor encourages me to assume an active role in planning my academic program	2	.7	13	4.8	84	30.8	174	63.7
Overall, I am satisfied with the support my advisor provides in relation to degree planning	5	1.8	20	7.3	104	31.9	144	52.7

Table 2 contains information that addresses the advisors concern for the graduate students' interest. The data shows that a majority of graduate advisors, within agricultural education, possess a student-oriented attitude (strongly agree = 56.3%; agree = 37.7%) and are willing to converse about academic endeavors (strongly agree = 60.8%; agree = 32.5%) as well as personal problems (strongly agree = 34.3%; agree = 50.7%). A majority of the participants strongly agree or agree that their advisor cares about their progress in the area of research (strongly agree = 45.5%; agree = 46.3%) and encourage them to be involved in student activities (strongly agree = 24.2%; agree = 45.9%) and join professional organizations (strongly agree = 37.3%; agree = 40.3%).

Table 2
Graduate Student Interests (N = 268)

Graduate Student Interests	Strongly Disagree		Disagree		Agree		Strongly Agree	
	<i>f</i>	%	<i>f</i>	%	<i>f</i>	%	<i>f</i>	%
My advisor cares about my progress in the area of research	4	1.5	18	6.7	124	46.3	122	45.5
My advisor encourages me to be involved in student activities	13	4.9	66	24.6	123	45.9	66	24.2

(continued)

Graduate Student Interests	Strongly Disagree		Disagree		Agree		Strongly Agree	
	<i>f</i>	%	<i>f</i>	%	<i>f</i>	%	<i>f</i>	%
My advisor possesses a student-oriented attitude	2	.7	14	5.2	101	37.7	151	56.3
My advisor is easy to talk to about my academic endeavors	3	1.1	15	5.6	87	32.5	163	60.8
My advisor is willing to discuss my personal problems	6	2.2	34	12.7	136	50.7	92	34.3
My advisor provides a caring, open atmosphere	3	1.1	19	7.1	100	37.3	146	54.5
My advisor encourages me to join professional organizations	7	2.6	53	19.8	108	40.3	100	37.3

Table 3 contains information on graduate student advisors' knowledge. Overall, a majority of graduate students either strongly agree (77.4%) or agree (22.3%) that their advisor is knowledgeable in their field of study. A majority of the participants also strongly agree (62.3%) or agree (35.8%) that their advisor is knowledgeable about research skills. According to the results, a majority of participants strongly agree (68.3%) or agree (27.9%) that their advisors are knowledgeable about courses offered within their department.

Table 3

Graduate Student Satisfaction with Advisor Knowledge (N = 265)

Advisor Knowledge	Strongly Disagree		Disagree		Agree		Strongly Agree	
	<i>f</i>	%	<i>f</i>	%	<i>f</i>	%	<i>f</i>	%
My advisor is knowledgeable in his/her field of study	0	0	1	.4	59	22.3	205	77.4
My advisor is knowledgeable about research skills	0	0	5	1.9	95	35.8	165	62.3
My advisor is knowledgeable about sources of funding available for research	3	1.1	15	5.5	88	33.2	108	40.8

(continued)

Advisor Knowledge	Strongly Disagree		Disagree		Agree		Strongly Agree	
	<i>f</i>	%	<i>f</i>	%	<i>f</i>	%	<i>f</i>	%
My advisor is knowledgeable about sources of funding available for participation in professional development and travel	3	1.1	18	6.8	100	37.7	92	34.7
My advisor is knowledgeable about courses that are offered within my department	0	0	10	3.8	74	27.9	181	68.3
My advisor is knowledgeable about courses offered outside my department	7	2.6	27	10.2	154	58.1	77	29.1
My advisor is knowledgeable about degree planning	2	.7	9	3.4	112	42.3	142	53.6
My advisor is knowledgeable about university policies and procedures	2	.8	14	5.3	119	44.9	130	49.1
My advisor is knowledgeable about professional organizations	3	1.1	14	5.1	130	49.1	118	44.5

Table 4 addresses the level of advisor support throughout the graduate school experience. A majority of graduate students strongly agree (45.8%) or agree (44.7%) that graduate advisors provide graduate students with the opportunity to improve their knowledge in their focus area. Most graduate advisors provide their graduate students with information about departmental procedures in relation to teaching (strongly agree = 34.4%; agree = 31.7%) and research (strongly agree = 35.9%; agree = 39.7%). A majority (strongly agree = 38.9%; agree = 41.2%) of graduate advisors provide their graduate students with an opportunity to improve their research skills. It is also noted that over 30% of the participants chose not applicable in regard to opportunities to teach undergraduate courses, assistance with securing funds for research, and providing an overview for departmental procedures when it pertains to travel. This is most likely due to the percentage of distance education students surveyed as well as graduate students who were on a non-thesis track.

Table 4
Graduate Student Satisfaction with Level of Advisor Support (N = 262)

Level of Advisor Support	Strongly Disagree		Disagree		Agree		Strongly Agree		Not Applicable	
	f	%	f	%	f	%	f	%	f	%
My advisor provides me with an overview of the departmental procedures in relation to research	4	1.5	25	9.5	104	39.7	94	35.9	35	13.4
My advisor provides me with an overview of the departmental procedures in relation to travel	4	1.5	29	11.1	87	33.2	57	21.8	85	32.4
My advisor provides me with an overview of the departmental procedures in relation to teaching	6	2.2	28	10.7	83	31.7	90	34.4	55	21.0
My advisor provides me with an opportunity to improve my research skills in my focus area	4	1.5	17	6.5	108	41.2	102	38.9	31	11.8
My advisor provides me with an opportunity to improve my knowledge in my focus area	5	1.9	12	4.6	117	44.7	120	45.8	8	3.1
My advisor provides me with advice on securing a job in my field of study	7	2.7	21	8.0	97	37.0	82	31.3	55	21.0
My advisor provides me with an understanding of my strengths and weaknesses	4	1.5	36	13.7	125	47.7	81	30.9	16	6.1

My advisor provides me with opportunities to make professional contacts within the profession	8	2.9	21	8.0	116	44.3	94	35.9	23	8.8
My advisor provides me with opportunities to conduct scholarly research	4	1.5	19	7.3	98	37.4	106	40.5	35	13.4
My advisor provides me with assistance in securing funds for research	5	1.9	35	12.8	75	28.6	53	20.2	94	35.9
My advisor provides me with opportunities to teach undergraduate courses	7	2.7	29	11.1	56	21.4	81	30.9	89	34.0
My advisor provides me with opportunities to establish career goals	5	1.9	22	8.4	100	38.2	106	40.5	29	11.1

Conclusions/Recommendations/Implications

Overall graduate students, within agricultural education are satisfied with the support that their advisors' provide in the area of degree planning. Graduate advisors in the agricultural education profession are well versed in graduate student degree requirements, clearly define graduate student degree requirements, and recommend courses that may help graduate students achieve professional and personal goals. Furthermore, agricultural education graduate advisors encourage graduate students to assume an active role in the planning of their own degree plan.

In regard to graduate student interests, agricultural education graduate advisors possess a student-oriented attitude and are open and willing to converse with their graduate students about academic endeavors as well as personal problems. Graduate advisors also encourage students to be involved in both student activities and professional organizations. Graduate advisors within agricultural education are knowledgeable in their field of study and in regard to the policies and procedures both in their department and at the university level. Graduate students perceive their advisors as being knowledgeable in research skills and in the area of funding available to conduct research and travel. Additionally, graduate advisors within agricultural education possess knowledge about courses offered within their department as well as outside of their department. Graduate advisors provide adequate support for graduate students in many important areas, but some graduate students do not feel that securing funds for research and travel, as well as the opportunities to teach undergraduate courses are applicable to their graduate program.

Agricultural education departments should continue with current methods and procedures of professional growth and new faculty induction. Graduate advisors are well versed in many areas, but those areas are continually changing, therefore graduate advisors should continue to communicate within the profession to keep abreast of any changes that may develop. Graduate advisors should also continue to lead by example to ensure that new faculty members entering the profession know how to successfully mentor graduate students throughout their graduate school experience.

The researchers recommend that future studies be conducted to further investigate the graduate student and advisor relationship. Specifically, these studies should focus on the preferred means of communication and the frequency of communication between graduate students and their advisors. Additionally, future research should be conducted within Colleges of Agriculture to determine the perceptions of other agricultural related graduate students.

The results of this study imply that current graduate advisors are leading by example and fully preparing new faculty to successfully advise graduate students. Departments of agricultural leadership, education, extension, and communications are providing their graduate advisors with the proper means to be a successful advisor and provide a positive experience for the graduate students within the field of agricultural education.

References

- Althaus, S. L. (1997). Computer-mediated communication in the university classroom: An experiment with on-line discussions. *Communication Education, 46*, 158-174.
- Bell, C. R. (2000). The mentor as partner. *Training & Development, 54*, 52-56.
- Dillman, D. A., Smyth, J. D., & Christian, L. M. (2009). *Internet, mail, and mixed-mode surveys: The tailored design method*. Hoboken, NJ: John Wiley & Sons, Inc.
- Gerholm, T. (1990). On tacit knowledge in Academia. *European Journal of Education, 25*(3), 263-271.
- Girves, J. E. & Wemmerus, V. (1998). Developing models of graduate student degree progress. *Journal of Higher Education, 59*(2), 184-192.
- Gorham, J. & Millette, D. M. (1997). A comparative analysis of teacher and student perceptions of sources of motivation and demotivation in college classes. *Communication Education, 46*, 245-261.
- Hartnett, R. T. (1976). Environment for advanced learning. In J. Katz & R. T. Hartnett (Eds.), *Scholars in the making: The development of graduate and professional students* (pp. 49-84). Cambridge, MA: Ballinger Publishing.
- Heiss, A. M. (1970). *Challenges to graduate schools*. San Francisco, CA: Josey-Bass, Inc.
- Lindner, J. R., Murphy, T. H., & Briers, G. E. (2001). Handling nonresponse in social science research. *Journal of Agricultural Education, 42*(4), 43-53.

- Lovitts, B. E. (2001). *Leaving the ivory tower: The causes and consequences of departure from doctoral study*. New York, NY: Rowman and Littlefield Publishers Inc.
- Lovitts, B. E. & Nelson C. (2000). The hidden crisis in graduate education: Attrition from Ph.D. programs. Retrieved September 8, 2010, from http://www.aaup.org/AAUP/CMS_Templates/AcademeTemplates/AcademeArticle.aspx. *Academe Online*.
- Osborne, E.W. (ed.). (n.d.). *National research agenda, agricultural education and communications: Research priority areas and initiatives, 2007-2010*. Gainesville, FL: University of Florida, Department of Agricultural Education and Communication.
- Powell, A. (1998). Faculty, graduate students explore graduate advising activities. *The Harvard Gazette*. Article 4.23. Retrieved September 9, 2010, from <http://www.news.harvard.edu/gazette/1998/04.23/FacultyGraduate.html>
- Repak, N. (n.d.). Professor/grad relationships: Maximizing the mentoring potential. *Journal of Grad Resources*. Retrieved September 8, 2010 from http://www.gradresources.org/articles/prof_grad.shtml.
- Rudd, E. (1986). The drop-outs and dilatory on the road to the doctorate. *Higher Education in Europe*, 11(4), 31-36.
- Schlosser, L. Z., Knox, S., Moskovitz, A. R., & Hill, C. E. (2003). A qualitative examination of graduate advising relationships: The advisee perspective. *Journal of Counseling Psychology*, 50(2), 178-188.
- Scott, C. R. & Rockwell, S. C. (1997). The effect of communication, writing, and technology apprehension on likelihood to use new communication technologies. *Communication Education*, 46, 44-62.
- Selke, M. J. & Wong, T. D. (1993). *The mentoring-empowered model: Facilitating communication in graduate advisement*. Paper presented at the Conference of the National Academic Advising Association, Bloomington, MN.
- Weiss, C. S. (1981). The development of professional role commitment among graduate students. *Human Relations*, 34(1), 13-31.
- Wrench, J., Punyanunt, N. M. (2004). Advisee-advisor communication: An exploratory study examining interpersonal communication variables in the graduate advisee-advisor relationship. *Communication Quarterly*, 52(3), 224-236.
- Zhao, C. M., Golde, C. M., McCormick, A. C., (2005, April). *More than a signature: How advisor choice and advisor behavior affect doctoral student satisfaction*. Paper presented at the meeting of the American Educational Research Association, Montreal, Canada.

Stages of Concern Profiles of Agricultural Technical School Teachers in Egypt for Implementing Student Internships

R. Kirby Barrick, Professor
Brian E. Myers, Associate Professor and Associate Chair
University of Florida

Mohamed M. Samy
Chief of Party, USAID MUCIA Value-Chain Training Project
Cairo

Abstract

Agricultural Technical School teachers in Egypt have participated in workshops to assist them in learning about, practicing and incorporating into their teaching the innovation of off-site student internships. Agriculture teachers do not complete formal preparation to become teachers in Egypt, so the development of programs such as internships is often neglected. ATS instructors may be reluctant to adopt new innovations, since there are few incentives to make change and few opportunities to learn new strategies. If workshops on internship programs are to be continued, the concerns of teachers regarding the adoption of the innovation can be valuable. ATS instructors who had participated in workshops on internship programs indicated some concern in adopting the innovation and in being well-prepared to utilize the strategies.

Introduction

Since 2007, professional development workshops focusing on implementing internship programs have been conducted for Agricultural Technical School (ATS) instructors in Upper Egypt through the Value-Chain Training project. The project is funded by USAID through the Midwest Universities Consortium for International Activities (MUCIA). The Concerns Based Adoption Model [CBAM] (Hall & Hord, 2006) provides a framework to evaluate one aspect of the effectiveness of this work. Specifically, the Stages of Concern (SoC) indicates what aspects of the innovation (internship programs) ATS instructors are focusing on in the implementation of the strategies. By identifying the ATS instructors' areas of concern in this implementation, future professional development sessions can be better designed to help instructors progress through the model to full implementation of internships in the ATS curriculum.

Conceptual Framework

Experiential learning has been an integral part of agricultural education programs in the United States for many years (Roberts & Harlin, 2007). However, prior to the implementation of the Value-Chain Training project, this pedagogy had not been adopted by ATS instructors in Egypt. It is theorized that educational principles transcend the borders of the United States and are therefore applicable in the ATS system in the Arab Republic of Egypt, which was the focus of this study. ATS instructors were provided inservice training that addressed planning, conducting, supervising and evaluating internship programs.

Experiential learning activities such as internships are relevant for teaching career skills to students. Osborne (1994) stated that experiential learning made students better able to transfer knowledge, understand problems in agriculture, develop their self confidence, connect practice and principle, improved psychomotor skills, develop problem solving skills, retain more knowledge, and become interested in learning. Joplin (1981) posited characteristics of experiential learning, including personal and student-based, process and product orientation, and evaluation. Kolb (1984) described a four-stage model of experiential learning, including concrete experience, reflective observation, abstract conceptualization, and active experimentation. “Students learn through real–life experiences and experience influences how they learn because experiences shape a persons’ schema by building knowledge and past experiences to influences future experiences” (Knobloch, 2003, p. 25).

A need exists for including experience-based programs in all program areas of the agricultural technical schools in Egypt. Workshops provide training for the ATS instructors so that they can ultimately provide better instruction to their students. Content in the ATS programs typically lacks real–life experiences outside of school, not utilizing the local resources necessary to conduct experiential learning activities (MUCIA, n.d.). The agricultural concepts and business skills that students need to learn cannot be synthesized from books, but require active participation (Roberts, 2006).

In order to determine how successful a professional development session is in bringing about a desired change, a number of factors can be considered. One of these is teacher concern regarding the innovation, which has been assessed in past research through the Stages of Concern Questionnaire (SoCQ) (George, Hall, & Stiegelbauer, 2006). Derived from Francis Fuller’s CBAM, the stages of concern profiles provide explanations regarding the developmental progression that individuals go through when adopting an innovation. These concerns typically begin with self-related concerns, and then progress to task-related concerns and finally impact-related concerns (Hall & George, 1979). The seven stages, shown in Table 1 (Hall & Hord, 2006), were originally identified through various research endeavors conducted by the staff members of the Research and Development Center for Teacher Education of the University of Texas at Austin in 1969. Innovation users can move through these stages according to their developmental familiarity with the innovation. While this developmental pattern is not a certainty, it remains fairly consistent (George, Hall, & Stiegelbauer, 2006).

Table 1

Seven Stages of Concern

Stage	Title	Description
6	Refocusing	The individual focuses on exploring ways to reap more universal benefits from the innovation, including the possibility of making major changes to it or replacing it with a more powerful alternative.
5	Collaboration	The individual focuses on coordinating and cooperating with others regarding the use of the innovation.
4	Consequences	The individual focuses on the innovation’s impact on students in his or her immediate sphere of influence.
3	Management	The individual focuses on the processes and tasks of

		using the innovation and the best use of information and resources.
2	Personal	The individual is uncertain about the demands of the innovations, his/her adequacy to meet those demands, and/or his/her role with the innovation.
1	Informational	The individual indicates a general awareness of the innovation and interest in learning more details about it. The individual does not seem worried about himself or herself in relation to the innovation.
0	Unconcerned	The individual indicates little concern about or involvement with the innovation.

Note: Adapted from George, Hall, & Stiegelbauer, 2006

Upon completion of the July 2007 workshops on supervised internship programs, participants indicated that they recognized the benefits of internship programs (Thoron, Barrick, Roberts & Samy, 2008). Participants also indicated that they would use the information gained in their teaching but were not clear regarding how to involve parents and employers. To identify the stages of concern perceived by teachers, the SoCQ has been used repeatedly in order to examine teacher concerns across academic settings (Christou, Eliophotou-Menon, & Philippou, 2004; Gwele, 1997; Shoulders & Myers, 2010). As the concept of internship programs expands in Egypt, more information is necessary in order to plan and conduct teacher inservice programs.

Purpose and Objectives

The purpose of this research was to assess Egyptian Agricultural Technical School (ATS) instructors' implementation of internships in their programs. In order to meet the purpose of this study, the following objectives were investigated:

1. Describe the population of ATS instructors who have participated in the MUCIA student internship development program.
2. Determine the Stages of Concern of ATS instructors who have participated in the MUCIA internship development sessions.
3. Examine relationships between Stages of Concern and years of involvement with internships, level of use of internships, experience conducting internship training, years of teaching, and involvement with other teaching innovations.

Methods

Population

The population for this study was Egyptian ATS instructors who had participated in the initial MUCIA professional development workshop on internships in July 2007. The researchers obtained a list of participants from the MUCIA Cairo Office Chief of Party. The workshops included instruction in 23 competencies that could be used by ATS instructors in implementing an internship program for their students.

Data Collection

A descriptive census survey design was used in this study. The researchers used a paper questionnaire to collect the concerns of Egyptian ATS instructors towards the implementation of internships. The researchers utilized the Stages of Concern Questionnaire (SoCQ) developed by George, Hall, and Stiegelbauer (2006). This questionnaire was composed of 35 Likert-type questions that assessed the concerns of the individuals involved in the educational innovation change process – the integration of internships into their programs. This questionnaire allowed respondents to indicate the relevance and intensity of their concerns towards internships. In addition to the SoCQ, demographic questions were included to better describe the population.

George, Hall, and Stiegelbauer (2006) stated that validity testing of the SoCQ has been performed by testing the relationship of the scales to one another and to variables from other concerns theories. George et al. utilized correlational matrices and factor analysis to determine that “the seven scales [in the SoCQ] tapped seven independent constructs that could be identified readily with the seven Stages of Concern proposed by the Concerns-Based Adoption Model (CBAM)” (p. 14). George et al. (2006) reported coefficients of internal reliability for each of the seven Stages of Concern which ranged between an alpha of .64 and .83 for the Stages of Concern Questionnaire. Santos (1999) stated an alpha score of .7 or greater is acceptable. George et al. also reported test-retest correlations for the SoCQ, which ranged between $r = .65$ and $r = .86$. These reported reliability scores fall within the acceptable range of reliability estimates as stated by Santos with the exception of Stage 0. Stage 0 has been under revision to help improve the reliability (Hall & Hord, 2006; George et al., 2006).

The instrument was translated into Arabic by staff of the Value-Chain Training program in Cairo, since most ATS instructors are only partly fluent in English. Minor modifications were made to some wording to help in the translation. The instrument was then translated back into English to reaffirm that the Arabic version replicated the original instrument.

There were 80 participants in the July 2007 workshops. For this study, a total of 59 usable responses were received, which represented the entire accessible population. Teachers who had participated in the workshop but were no longer teaching were not included in the study; likewise, headmasters and education supervisors were deleted from the participant list. The instrument was administered by Value-Chain Training staff, resulting in a complete set of responses from participants who had completed a workshop and were still teaching.

Data Analysis

Responses were analyzed using the calculations recommended by George, Hall, and Stiegelbauer (2006) and developed in Excel format by Scott and Persichette (2006). Raw scores in each stage of concern were averaged by different groupings according to variables identified in the objectives. In order to perform accurate analysis, average raw scores of different variable groups in each stage of concern were converted into percentile scores. Examination of group data can be done through averaging raw scores before converting to percentile scores, as percentile scores do not have equal intervals. The 2006 Stages of Concern Questionnaire publication by George, Hall, and Steigelbauer, as well as the Excel program, provides the raw score-percentile conversion chart and can be utilized for producing individual and group profiles (George, Hall, & Stiegelbauer, 2006). This percentile chart was utilized throughout the previously-mentioned validation studies and has proved to be representative of various

innovations (George, Hall, & Stiegelbauer). When analyzing percentile scores, the higher the score, the more intense the concerns are at that stage. Because percentile scores in each stage of concern are dependent on one another, analysis was conducted through the use of a concerns profile. The concerns profiles create visual images of the average concern intensities of a group of respondents, as recommended by George, Hall, and Steigelbauer, and are the most interpretive and most frequently used method for analyzing SoCQ data (2006). The use of percentile scores is not recommended for statistical analysis due to the violations of assumptions on which the tests are based, so data were only analyzed through descriptive measures (George, Hall, & Stiegelbauer, 2006).

Results and Conclusions

Description of the Population

Participants in the study were teachers in one of the program areas offered at the Agricultural Technical Schools in Upper Egypt: horticultural production, laboratory technician, agricultural mechanization and land reclamation, fish production and processing technology, food processing and pastry, and animal and poultry production. The 59 teachers were employed in five different schools. The average age of the participants was 42 years, with a range of 25 to 58 years. The typical teacher had taught 11.2 years, with a range of 3 to 27 years. Nearly all of the teachers are male.

Stages of Concern

An overall concerns profile was developed to illustrate the concerns of the population regarding implementing active learning strategies into the Egyptian ATS classroom. The primary and secondary Stages of Concern for the group concerns profile was established. Categorization of the overall concerns profile were made according to the guidelines set forth by George et al. (2006). Differences in overall concerns profile scores as well as individual stages development scores were developed among program area groups and between gender groups. A lack of differences between male and female instructors could probably be accounted for by the relatively small number of women in the study.

Involvement with Internships

The concerns profile found in Figure 1 was constructed based on teachers' years of involvement with internships. Four groups were established to make comparisons: Never ($n = 4$), 1 year ($n = 20$), 2 years ($n = 25$), and 3 or more years ($n = 10$). Teacher groups with no involvement or one year of involvement with internships were found to have high concern levels in Stage 1 as compared to their other stages. This can be interpreted as these not being concerned currently with this innovation; both show signs of their interest to gain more information about the innovation itself and how to implement it in their classrooms/schools. Group profiles for both of these teacher groups also showed the lowest level of concerns in Stage 4. This suggests that teachers in these groups have minimal concerns about the effects of the innovation on the students involved. The highest concern level for teachers with two years of involvement with the innovation was reported in Stage 2. A group profile with the highest level of concerns in this stage is indicative of teachers with a high level of personal concerns. These personal concerns can include teacher's uncertainty as to how they will be perceived by their colleagues for implementing the innovation and how getting involved with internships could negatively affect their professional status and success. The group concerns profile for the teachers with three or more years of involvement with internships shows the highest levels of

concern in State 5 and the lowest level in State 3. This concerns profile suggests that this group of teachers have moved beyond concerns about how to manage the innovation in their own classrooms/program (low Stage 3) and are now more concerned about how to collaborate with others to help them be successful in implementing the innovation (high Stage 5).

How long have you been involved with internships

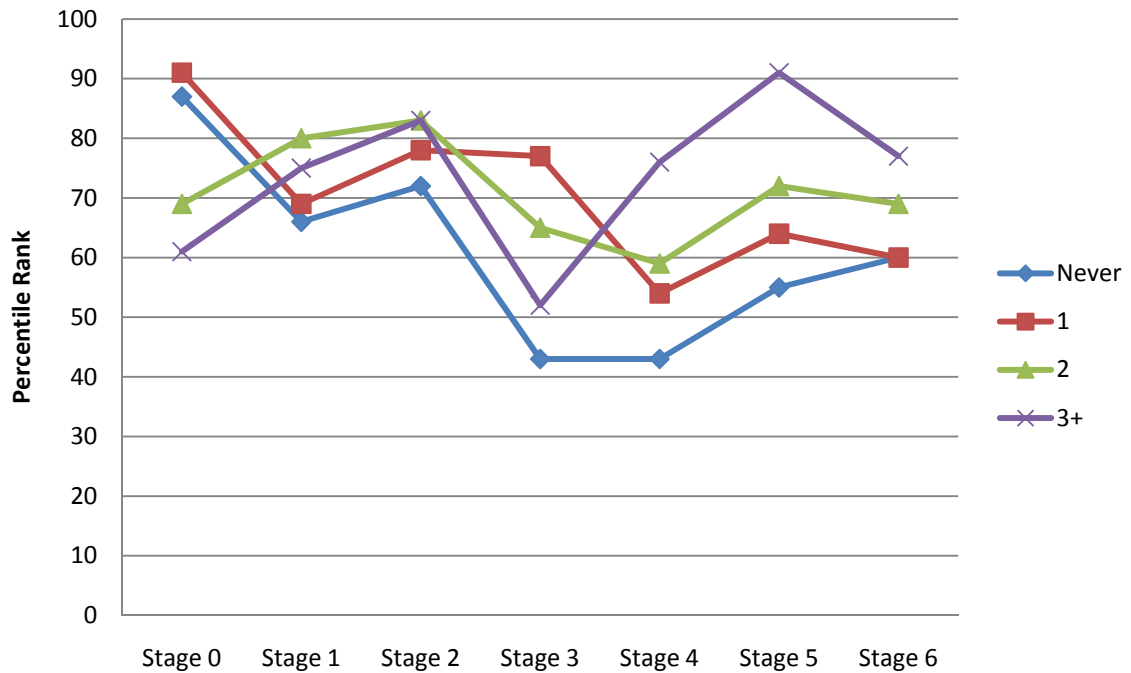

Figure 1. Involvement with Internships

Level of Use of Internships

Respondents were asked to classify themselves regarding their use of internships in their programs – non user ($n = 7$), novice ($n = 12$), intermediate ($n = 26$), expert ($n = 11$), and past user ($n = 3$). The concern profiles of all groups show no signs of teacher resistance to the innovation or its implementation. The group of teachers who self-identified as non user showed their highest concern level in Stage 2. This suggests that teachers in this group have intense personal concerns about the innovation and its consequences for them. This sense of uneasiness does not necessarily indicate resistance. Teachers in the novice group have a large gap in their Stage 3 and Stage 4 level concerns as indicated on their concerns profile. This gap suggests that this group of teachers is more concerned on the management or logistics of the innovation, in this case internships, than they are on the impact such a program would have on the students. The concerns profile for the past user group suggests that teachers in this group have intense involvement with the innovation and have possibly even made their own personal modifications to the innovation as presented to them, as indicated by having their lowest concerns level at Stage 0, and are focusing on the impact of the program on students and how to collaborate with other teachers (highest level concerns at Stages 4 & 5).

What is your level of use with internships

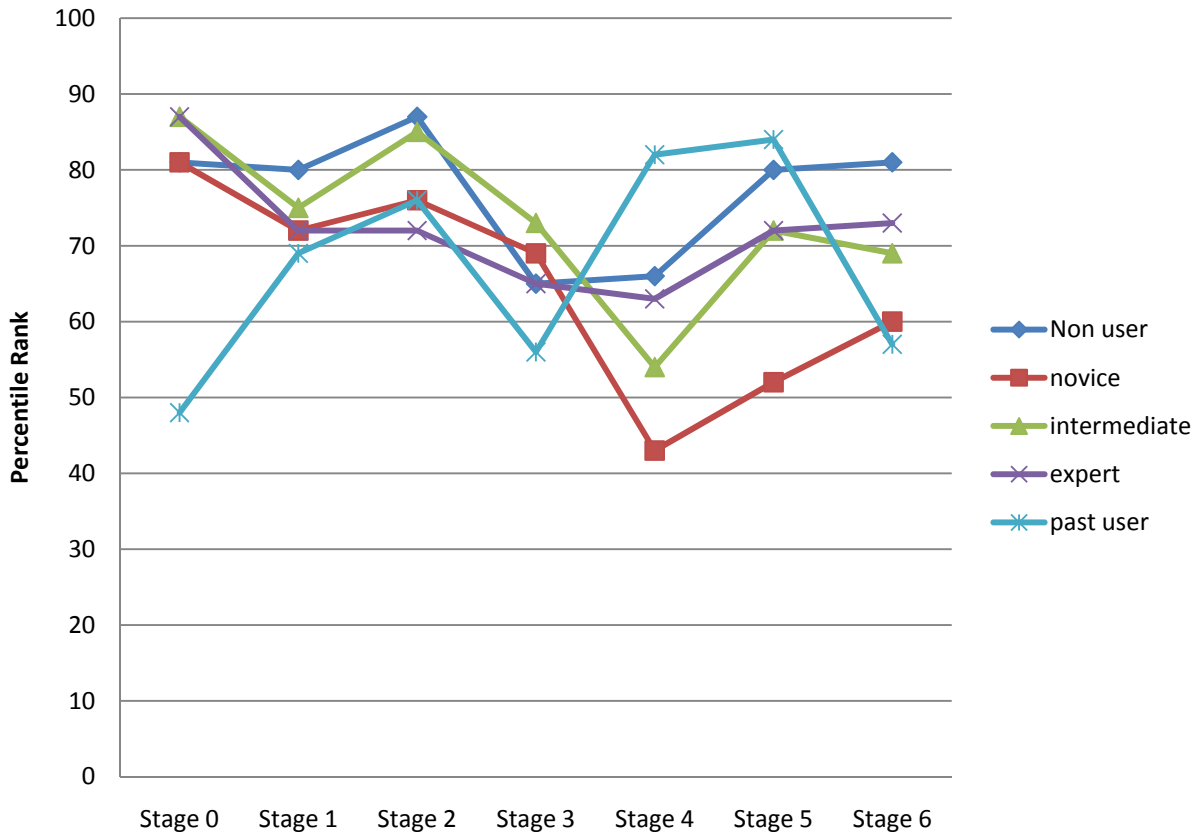

Figure 2. Level of Use of Internship Programs

Experience Conducting Internship Training

The Value-Chain Training project involves the train-the-trainer mode of dissemination. Teachers are expected to provide instruction to their colleagues regarding the new strategies they have acquired. Teachers were asked to indicate if they had ever conducted workshops for other teachers on internships. Comparing the two user profiles revealed some interesting findings. Teachers who had not conducted trainings ($n=45$) showed high concern levels in Stage 2 and low concern levels at Stage 4 (Figure 3). This finding suggests that these teachers are focused on personal concerns more than the impact that the innovation could have on students. The concern profile of the group consisting of teachers who had conducted workshops on the topic ($n=14$) suggests these teachers have very low concerns about how to conduct and supervise internships (Stage 3) and focus on helping other teachers integrate the innovation in their schools (Stage 5).

Have you conducted training with internships

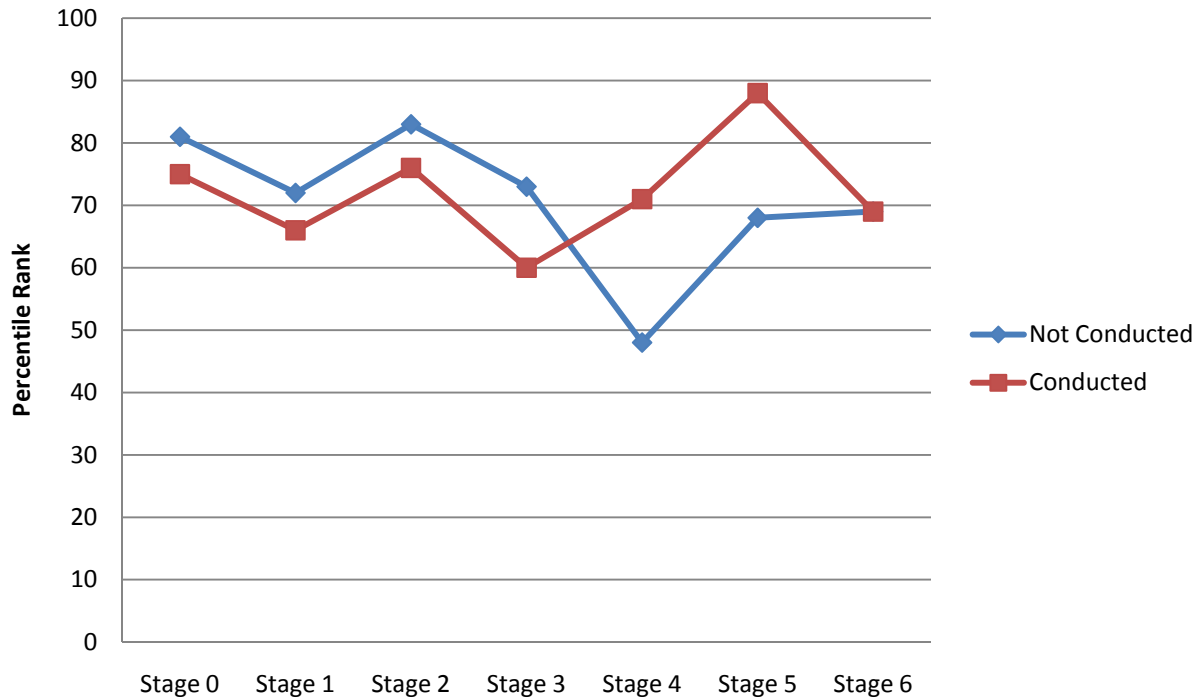

Figure 3. Experience Conducting Internship Development Training

Years of Teaching

A concerns profile was created based on grouping teachers based on years of teaching experience (Figure 4). Teachers in the 1-5 years of experience group ($n = 2$) were found to have highest concerns at Stage 0 and show a large gap between Stage 3 and Stage 4 on the group concerns profile. This suggests that these teachers are not actively involved in the innovation and are concerned with how to manage the classroom and the innovation. The 6-10 year teacher group ($n = 6$) showed a similar split between Stage 3 and Stage 4, albeit less dramatic than that found on the beginning teacher profile. In reviewing the group profiles of the other teacher groups (11-15, $n=29$; 16-20, $n=18$; 21+years, $n = 4$), no trends could be detected regarding implementation of the innovation.

How long have you been teaching

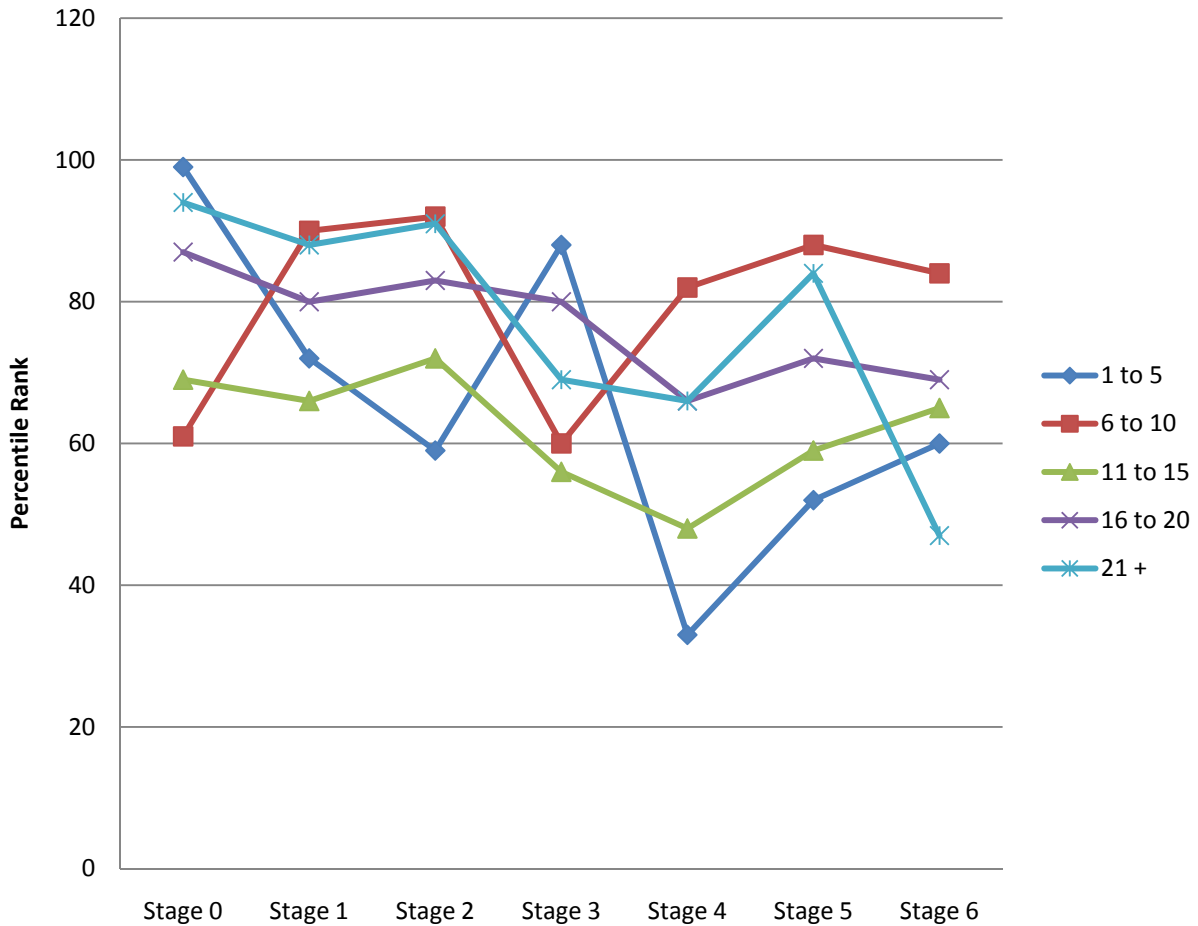

Figure 4. Number of Years of Teaching

Involvement with Other Teaching Innovations

Respondents reported their involvement in the first or second year of other innovations beside active learning strategies at their school. More teachers indicated they were not involved in other innovations ($n = 34$) than indicated they were involved in multiple innovation implementations ($n = 25$). The concerns profile comparing these two groups found very similar results between the two groups (Figure 5). The only distinguishing factor between the two was those involved in other innovations had high personal concerns as indicated by concerns in Stage 2 being the highest in their group concerns profile.

Are you currently involved with other innovations besides internships

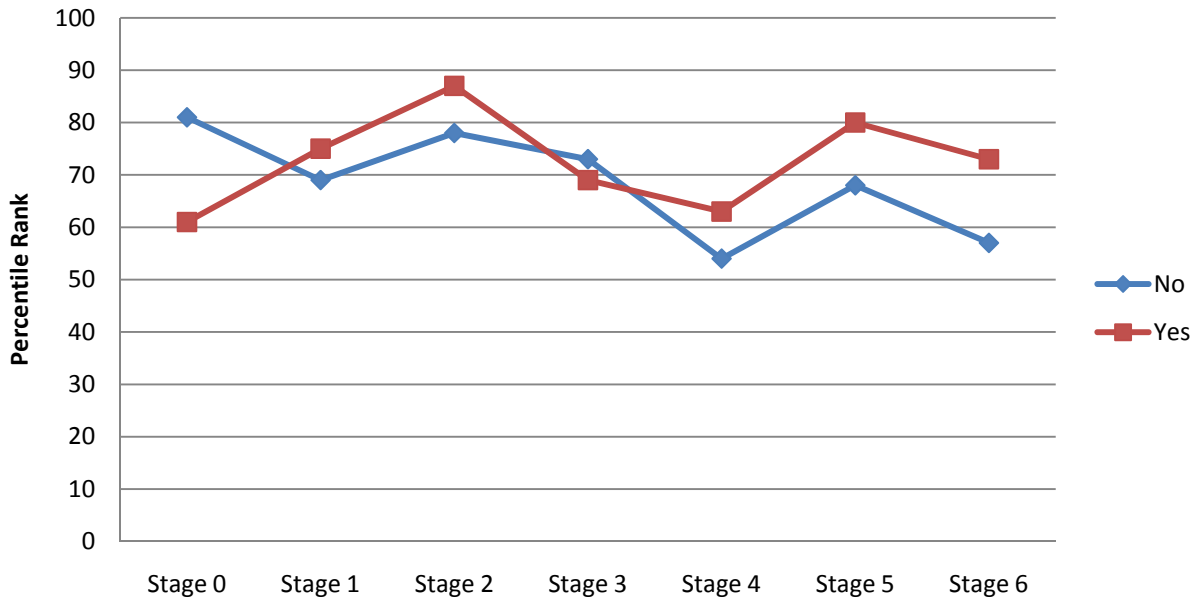

Figure 5. Involvement with Other Teaching Innovations

Recommendations and Implications

Results of the Stages of Concern analysis will be used in determining additional inservice educational needs of Agricultural Technical School instructors who have participated in past activities as well as planning future workshops for other instructors. Based on the analysis of the group concern profiles, four conclusions can be drawn.

1. As ATS teachers became more involved in the innovation, student internships, they tended to progress through the stages of concern as posited by Hall and Hord (2006).

Teacher groups with the most experience and involvement with the innovation showed the highest concern levels in later stages of the concern model while those with less experience had highest concerns in the earlier stages. This reinforces the position stated by Hall and Hord (2006) that professional development experiences need to be built to assist teacher progress through the stages. Teachers who had the most years of experience with the innovation tended to also be the teachers who conducted the training on the innovation to other teachers. Further investigation is needed to verify the impact of the train-the-trainer model on those that do not have the opportunity to act as a workshop trainer.

2. Early users tended to have high personal and/or management concerns regarding implementing the innovation.

In many of the group concerns profiles it was found that teachers that were early in the use or had not yet used the innovation had high concerns in how the innovation would impact them, both

personally and professionally. These concerns could include things such as social standing with other teachers, teacher self-efficacy, job security, and other related issues. They were also highly concerned on the logistics of implementing the innovation. They were focused on how to manage the process. Further research should be conducted to identify the specific aspect of the internship process that is of most concern to these teachers and then develop professional development opportunities to address those concerns.

3. Total years of teaching experience did not tend to impact concern level regarding the innovation.

Overall trends did not emerge by analysis of group concern profiles of teachers based on years of experience. Early career teachers did show some signs of greater personal and management concerns regarding the innovation than other groups, which is consistent with previous research conducted domestically (Warner & Myers, 2010; Shoulders & Myers, 2010) and internationally (Myers, Barrick, & Samy, 2010), but no substantial trends were discovered. Thus it can be concluded for this group of individuals, total teaching experience was not a major factor in concern level regarding the use of student internships.

4. Teachers in the first or second year of another innovation implementation had high personal concerns.

This conclusion is consistent with that of Hall and Hord (2006). It is often challenging for teachers to manage implanting multiple innovations at the same time. Teachers showed high personal concerns which can stem from their fear of retributions from administrators and other teachers for failing to implement the innovation championed by that individual. Further, introducing multiple changes into the classroom can be disruptive to the students. Further investigation should be conducted to determine the other innovations being implemented and the drivers of those innovations.

The concerns faced by Egyptian ATS instructors in managing innovations are similar to those faced by American agriculture teachers (Warner & Myers, 2010; Shoulders & Myers, 2010). Thus, American agriculture teacher educators should become more involved in international professional development to apply and continually assess the effectiveness of professional development models to assist in the adoption and implementation of new instructional techniques.

The findings of this research provide valuable insight to the leaders of the student internship program in Egyptian Agricultural Technical Schools. Further, leaders of other educational innovations can garner insight on the adoption process to ease the implementation of other ideas. This information should be used by program leaders to develop professional development opportunities and other support mechanisms for teachers involved in this project.

References

- Christou, C., Eliophotou-Menon, M., & Philippou, G. (2004). Teachers' concerns regarding the adoption of a new mathematics curriculum: An application of CBAM. *Educational Studies in Mathematics*, 57(2), 157-177.
- George, A. A., Hall, G. E., & Stiegelbauer, S. M. (2006). *Measuring implementation in schools: The stages of concern questionnaire*. Austin, TX: SEDL.
- Gwele, N. S. (1997). The development of staff concerns during implementation of problem-based learning in a nursing programme. *Medical Teacher*, 19(4), 275-285.
- Hall, G. E. & George, A. A. (1979). *Stages of concern about the innovation: The concept, initial verification and some implications* (ERIC No. 187716). Retrieved from <http://www.eric.ed.gov/PDFS/ED187716.pdf>
- Hall, G. E., & Hord, S. M. (2006). *Implementing change: Patterns, principles, and potholes* (2nd ed.). New York: Pearson Education.
- Joplin, L. (1981). On defining experiential education. In K. Warren, M. Sakofs, & J.S. Hunt (Eds.), *The theory of experiential education* (pp. 15-22). Dubuque, IA: Kendall/Hunt Publishing.
- Knobloch, N. A. (2003). Is experiential learning authentic? *Journal of Agricultural Education*, 44(4), 22-34.
- Kolb, D.A. (1984). *Experiential learning: experience as the source of learning and development*. Upper Saddle River, NJ: Prentice Hall.
- MUCIA (n.d.). *Request for Second Amendment to the AERI Linkage Project*. Unpublished manuscript.
- Myers, B.E., Barrick, R.K., & Samy, M.M. (2010, May). *Stages of concern profiles for active learning strategies of agricultural technical school teachers in Egypt*. Paper presented at the 26th Annual Conference of the Association for International Agricultural and Extension Education, Saskatoon, Canada.
- Osborne, E. (1994). Completing the cycle. *The Agricultural Education Magazine*, 67(3), 3, 11.
- Roberts, T. G., & Harlin, J. F. (2007). The project method in agricultural education: Then and now. *Journal of Agricultural Education*, 48(3), 46-56.
- Santos, J.R.A. (1999). Cronbach's alpha: A tool for assessing the reliability of scales. *Journal of Extension*, 37(2).

- Scott, D. & Persichette, K. (2006). SOCQ-075-Graph-and-Print [Computer program for Microsoft Excel]. Austin, TX: Southwest Educational Development Laboratory.
- Shoulders, C. W., & Myers, B. E. (2010, May). An analysis of National Agriscience Teacher Ambassadors' Stages of Concern regarding inquiry-based instruction. *Proceedings of the 2010 Agricultural Education AAE Research Conference*, 214-228.
- Thoron, A.C., Barrick, R.K., Roberts, T.G., & Samy, M.M. (2008, March). Establishing technical internship programs for agricultural technical school students in Egypt. *Proceedings of the 24th Annual Meeting of the Association for International Agricultural and Extension Education*, San Jose, Costa Rica.
- Warner, A. J., & Myers, B. E. (2010, May). Agriscience teachers' concern profiles for content area reading strategies. *Proceedings of the 2010 Agricultural Education AAE Research Conference*, 184-198.
-

Programs described in this paper are being undertaken by the Midwest Universities Consortium for International Activities, Inc. and are made possible by the generous support of the American people through the United States Agency for International Development (USAID). The contents of this paper are solely the responsibility of the authors and do not necessarily reflect the views of USAID or the United States Government.

Corn Clubs: A Historical Inquiry

Cassie Uricchiuo, Michael Coley, Gary Moore, North Carolina State University

Many professionals in agricultural and extension education are aware of the existence of corn clubs and the professional literature of the field has numerous references to corn clubs. Yet, if one were pressed to provide detailed information about the purposes and organization of the corn clubs, it might be a difficult task. To put it bluntly the profession is aware of the existence of corn clubs but really doesn't know their purposes or how they were organized.

Corn clubs were local organizations consisting of boys who cultivating corn on one acre of land (generally on their father's farm) under the supervision of a local club leader. At the end of the season, both the yield per acre and production cost per bushel were calculated. This experiential learning method greatly benefited the boy and encouraged him to improve his agricultural knowledge and skills from year to year.

The leaders were often school teachers, county extension agents, and eventually, agricultural teachers. The boys received practical instruction in improved farming methods, kept records on their yields, and exhibited at local, regional, and state corn contests. Two major factors led to the development of corn clubs in the early 1900s: 1) The fact that many farmers were most easily interested in better methods of corn growing through their sons, and 2) The desire of the Department of Agriculture to educate future farmers in better agricultural practices (Clark, 1984). As corn clubs developed, their success led to the development of a variety of other boys' and girls' clubs including potato clubs, poultry clubs, and tomato clubs. Corn clubs continued to hold the largest membership of any youth agricultural club through 1920 (Clark, 1984).

There are several reasons why professionals in agricultural and extension should possess more than a cursory knowledge of corn clubs. A better understanding of corn clubs might give the profession a greater insight into the pedagogy involved in the corn club movement which could be useful in education today. It is possible some of the procedures and techniques involved in corn clubs could be replicated today. Also, having an understanding of the past tends to give one a greater appreciation for the evolution of the profession.

Purpose and Objectives of the Study

The overall purpose of this study was to document the organization, operation and outcomes of the corn clubs. The specific objectives of the study were to answer the following questions:

1. Who was responsible for organizing the corn clubs?
2. What were the stated purpose(s) of the corn clubs?
3. How did corn clubs operate?
4. What were the outcomes (benefits) of the corn clubs?

Theoretical Framework

The theoretical framework for this research is embedded in the concept of agricultural literacy. In *Understanding Agriculture: New Directions for Education* (National Research Council, 1998), the Committee on Agricultural Education in Secondary Schools state "...that an agriculturally literate person's understanding of the food and fiber system would include its history and its current economic, social and environmental significance to all American's." (p. 8-9). The Committee heartily recommended that "All students should receive at least some systematic instruction about agriculture..." (p.10).

The need for agricultural literacy is further emphasized in the *Reinventing Agricultural Education for the Year 2020* project (The National Council for Agricultural Education, 2009). Goal 3 states that all students are conversationally literate in agriculture, food, fiber and natural resource systems.

These agricultural literacy recommendations should be extended to professionals in the field of agricultural and extension education as well. We, the profession, need to be literate regarding our own history; and this would include knowledge of corn clubs.

Methodology

Historical research methods were used in this study. According to Fraenkel & Wallen (2009) there are five reasons for conducting historical research:

1. To make people aware of what has happened in the past so they may learn from past failures and successes.
2. To learn how things were done in the past to see if they might be applicable to present day problems and concerns.
3. To assist in prediction.
4. To test hypotheses concerning relationships or trends.
5. To understand present educational practices and policies more fully.

Historical research involves the systematic search for documents, artifacts and other sources of information related to the objectives of the study (Borg & Gall, 1983). The researchers focused mostly on primary sources such as original United States Department of Agriculture documents, General Education Board reports, state corn club documents, and related materials. Secondary sources such as articles in journals and book chapters were also used. Original documents were obtained from the U. S. Government depository of a university library and through inter-library loan.

All sources were subjected to both external and internal criticism. To establish external criticism the researchers carefully examined each document to ascertain if it were an original document and was written by the person or group who claimed to write the document. Internal criticism was determined by examining the accuracy or the information presented and the truthfulness of the writers.

According to Lincoln and Guba (1985, p. 290) historical and other qualitative research should be "worth paying attention to" which they refer to as trustworthiness. The four criteria identified by Lincoln and Guba (1985) as comprising trustworthiness are credibility,

transferability, dependability and confirmability. Triangulation was used to establish credibility; multiple sources were used to validate the information presented. Sufficient detail (often identified as thick description) is used to satisfy the transferability criterion. This allows the reader to determine the extent to which the conclusions made are transferable to other times, settings, and situations. Space limitations prevent the authors from providing extensive details in this document but sufficient detail is provided. Dependability was established by conducting an external audit. An external audit involves having an outside researcher not involved in the study to evaluate the both the process and product of the research study. The purpose of this audit is to evaluate the accuracy and determine whether or not the findings, interpretations and conclusions are supported by the data. The current historian of the American Association for Agricultural Education conducted this audit. All data collected in this research inquiry has been retained and are on file for purposes of confirmability

Results

Corn has been an important agricultural commodity in the United States for hundreds of years. If it were not for corn, the colonists at Jamestown and Plymouth would not have survived (Wessel, 1976). In the Annual Reports of the Department of Agriculture for the year 1850, corn's role as a principal crop was emphasized, "...no other crop, not even cotton, has equal commercial importance" (United States Department of Agriculture, 1851, p. 24).

Question 1 - Who was responsible for organizing the corn clubs?

It would be difficult to single out one specific group as starting corn club work. A variety of organizations including land grant colleges, agricultural societies, public schools, state departments of agriculture, the United States Department of Agriculture and the General Education Board were all involved in establishing corn clubs.

The first corn club was probably organized by W. B. Otwell in Macoupin County, Illinois in 1900 as an attempt to improve attendance at farmers' institutes (True, 1929). Otwell, the president of the county farmers' institute, distributed corn to five hundred boys which they cultivated and exhibited at a corn contest during the next institute. This was so successful that corn was distributed to 1,500 boys in the county the following year. Similar corn clubs began sprouting up in other counties with much success. These local clubs were united into a county corn club association cooperatively directed by the Illinois Farmers' Institute, state college of agriculture, county institute secretaries, and county superintendents of schools.

In 1903, the Office of Experiment Stations in the United States Department of Agriculture added a Farmers' Institute Specialist to organize institutes for the diffusion of agricultural knowledge to local farmers. By 1906, all states and territories except Alaska conducted Farmers' Institutes and the scope of this work was expanded to include boys' and girls' clubs (United States Department of Agriculture, 1907). These clubs were not only an attempt to stimulate interest in Farmers' Institutes, but ultimately replace the need for adult farm demonstration work (True, 1929; The General Education Board, 1916). Corn was selected as the focus of many boys' clubs due to its economic importance, adaptability to different growing conditions, increasing demand for production, and physical traits which made corn easier to measure and select (United States Department of Agriculture, 1913; The General Education Board, 1916).

Numerous states established corn clubs in the early part of the century and in 1907, the United States Department of Agriculture reported that boys' corn clubs were rapidly growing in favor (United States Department of Agriculture, 1908). In 1908, Seaman A. Knapp began to organize southern boys' corn clubs under the Farmers' Cooperative Demonstration Work division of the United States Department of Agriculture (True, 1929). Although corn clubs had been established in other states for some years before this change, Knapp's efforts resulted in the successful systematic organization of the corn club movement. The first government report on boys' corn clubs appeared in the Annual Reports of the Department of Agriculture for the year 1909. The southern states boasted a membership of 10,543 boys in corn clubs across the region (United States Department of Agriculture, 1910). F. W. Howe, a former instructor in agriculture at Michigan Agricultural College, was appointed the new director of educational work of the Office of Experiment Stations under A. C. True, Director (United States Department of Agriculture, 1910). Howe had organized boys' corn clubs in Michigan and his plans for 1909-1910 included a specific objective of promoting boys' agricultural clubs in different parts of the country. During his first year, corn club membership in the south increased more than fourfold to 46,225 members in 1910 and corn clubs were established in both the northern and western regions of the country (United States Department of Agriculture, 1910). In addition, the Office of Experiment Stations cooperated with the Bureau of Plant Industry's foreign seed and plant introductions program to send certain foreign introductions to boys for testing (United States Department of Agriculture, 1910, p. 687-688). The goals of this project were to increase interest in both competitive crop growing and the Department of Agriculture's efforts to introduce new agriculture plants.

The boys' corn club movement was an important part of the Farmers' Cooperative Demonstration Work. S. A. Knapp (1910) stressed the value of corn clubs in "The Mission of Cooperative Demonstration Work in the South" circular:

We want to reach the home through the boys and the teaching of agriculture... Thus we have devised these boys' corn clubs so that the boys may become interested in doing things [in agriculture]. The club does more than that. It teaches him to do one thing and do it well... Let the boy do, even if he makes mistakes... My ideal of education is that of practical sense, leadership. Get that sense into a boy and he will take up farming, and if he knows a few fundamental principles he will apply the rest. (p. 5-6)

Interest in boys' corn clubs continued to increase and in 1911, the Farmer's Cooperative Demonstration Work included boys' corn club work in North Carolina, South Carolina, Georgia, Alabama, Mississippi, Louisiana, and Arkansas (United States Department of Agriculture, 1912). In 1912, membership in the south rose to 67,179 boys (United States Department of Agriculture, 1913). Twenty corn club agents were employed and the corn club movement continued to expand into northern and western states: "...cooperative arrangements for corn-club work have already been made with 8 states, with an approximate enrollment of 20,000 boys" (United States Department of Agriculture, 1913, p. 442). Corn club membership grew more rapidly in the north than in the west; nonetheless the corn clubs grew to be "by far the most widespread and numerous organization of this character" (True, 1915, p. 6).

The supervision of boys' corn clubs work was overseen by different offices of the Bureau of Plant Industry in different regions. Boys' corn club work was supervised by the Office of

Farmers' Cooperative Demonstration Work in the southern states and by the Office of Farm Management in the northern and western states (Knapp & Martin, 1913).

Many of the corn clubs emerged from the Farmer's Institutes, but the institutes were sponsored by various entities. In 1909 Farmer's Institutes were operated by land grant colleges in 19 states and state departments of agriculture or state agricultural societies in 17 other states (True, 1929). At the same time the General Education Board was hiring farm demonstration agents to work in the southern state and their responsibilities included establishing corn clubs. The USDA was publishing bulletins and activity promoting corn clubs (Crosby, 1904). So the General Education Board and the USDA were involved in the corn club movement. Some school teachers and superintendents were establishing corn clubs in schools (Duncan, 1911; Nolan & Greene, 1917). At times this was in conjunction with other groups and at times it was independent of other groups (Davis, 1911; Graham, 1941). The Alabama Department of Education (1910) even published a manual for schools on how to organize corn clubs. It was not always clear which group should get credit for the corn club work. An example is I. O. Schaub of North Carolina who was the state leader for corn club work between 1909 and 1916. His salary was paid by the General Education Board and the USDA (\$1), he was officially a member of the Department of Extension at North Carolina Agricultural and Mechanical College, but he was listed as an employee of the state Department of Education and provided annual reports to the state school superintendent regarding corn club activities (Armstrong, 1929).

Question 2 - What were the stated purpose(s) of the corn clubs?

In 1913, the Bureau of Plant Industry published a circular on the "Organization and Instruction in Boys' Corn-Club Work" for the thirty-three northern and western states. The objectives of the corn clubs were outlined in detail (Benson, 1912, p. 2-3):

1. To encourage more intensive farming by using the best known methods of soil building, selection of seed, seed testing, cultivation of corn, etc.
2. To offer a medium through which vocational guidance inspiration, information, and careful direction can be given to the average boy now in rural life.
3. To adapt the boy to his agricultural environments and make him capable of self-expression within those environments
4. To teach the value of intellectual guidance, careful observation, cultural comparison and investigation, and the need of a broader education for the farming population.
5. To teach the boy the proper adaptation of plant life to local and climatic and soil conditions.
6. To assist the teacher and the public schools to find an easy approach, educationally, to all the interests of rural and village life.

In the same year, the Bureau of Plant Industry published a circular on "Boys' Demonstration Work. The Corn Club." for the fifteen southern states. The objectives of the corn clubs were also presented (Knapp & Martin, 1913, p. 1-2):

1. To place before the boy, the family, and the community in general an example of crop production under modern scientific methods.
2. To prove to the boy, his father, and the community generally that there is more in the soil than the farmer has ever gotten out of it; to inspire the boy with the love of the

land by showing him how he can get wealth out of it by tilling it in a better way and keeping an expense account of this undertaking.

3. To give the boys definite, worthy purposes at an important period in their lives and to simulate a friendly rivalry among them.
4. To furnish an actual field example in crop production that will be useful to rural school teachers in vitalizing the work of the school and correlating the teaching of agriculture with actual practice.

It is apparent from these objectives that the purpose of these corn clubs was not just improving corn production, but also the building of character. Yet, the boy was not the only target of these said objectives. The overall purpose of the corn club movement was much further reaching:

The objects of organizing the boys, under twenty-one years old, in Alabama into Corn Clubs are to increase the production of corn, to improve the seed, to aid the young farmers in better methods of cultivation and a more intelligent use of fertilizers, to increase the interest of the farm boys in agriculture, and to encourage them to get an education along agricultural lines and remain on the farm. Of course arousing interest in one crop will lead to similar lines of work with other crops and will ultimately result in a more careful study of methods with all lines of farming. This will lead to increased production on the farm and will lay the foundations for better schools, better roads, better churches, improvement of the social life in the rural districts and a more contented and happy people. (Duncan, 1911)

The boys' successes roused more interest and enthusiasm from citizens of the county than any demonstration work with adult farmers and "turned attention to the farm" (United States Department of Agriculture, 1911, p. 83). In 1909, over \$10,000 in prizes were contributed by the public to encourage boys' corn clubs in the southern states; by 1910, the contributions rose to over \$40,000 (United States Department of Agriculture, 1910; United States Department of Agriculture, 1911). These contributions included both monetary donations and practical items. The corn club movement attracted much attention, fueling public interest in better agriculture and the country's agricultural resources (United States Department of Agriculture, 1912).

In addition to the avowed educational purposes of the corn club, there were perhaps some selfish reasons for their existence. William B Otwell of Illinois was a great promoter of corn clubs and corn growing contests. Otwell is one of the Illinois representatives in the National 4-H Hall of Fame (n.d). His Hall of Fame information states:

Otwell saw that few farmers seemed interested in attending meetings, so he decided to concentrate on youth. When Otwell offered a \$1 premium for the best yield of corn produced from Midwestern seed that he collected, more than 500 boys entered the contest. By 1901 it attracted 1,500 boys. . . . By 1904 the contest grew to 50,000 youth. The event was featured at the 1904 Louisiana Purchase Exposition in St. Louis, where samples from the best 1,250 contestants and 600 photographs of young corn growers were on exhibit. Nationwide, newspapers carried stories of the pyramid of corn from Illinois. The next year, Otwell invited youth from across the country to a national corn growing roundup. Government officials watched as young men and women from eight

states paraded past the reviewing stand. 4-H was a merger of Otwell's concept with that of organizing rural youth into clubs and groups.

However, in a biography of A. B. Graham, one of the founders of 4-H, it is reported that "...his [Otwell's] correspondence with Graham clearly identifies him as a business man interested in selling farmers better quality seed corn. Boys who won prizes for their accomplishments were excellent advertisements." (McCormick and McCormick, 1984, p. 154). While Otwell may have had noble intentions, the fact remains that he was profiting from the corn clubs.

Question 3- How did corn clubs operate?

In order to accomplish the stated purposes of the corn club movement, cooperation among departments, agricultural colleges, county superintendents, county agents, and teachers was crucial. Corn club work was conducted in cooperation with school officials and teachers in rural communities and supervised by state agents in agricultural colleges who represented both the United States Department of Agriculture and the college (True, 1915). Some states had a separate state leader for boys' and girls' club work, while in other states, the state leader for county agent work also directed the club work (True, 1915). In 1912, there were twenty boys' clubs county agents in the South (United States Department of Agriculture, 1913); by 1919, the number rose to thirty-one (United States Department of Agriculture, 1920). County agents organized and maintained the club work in each county (True, 1915).

The work of the state leaders and county agents was heavily supplemented by that of volunteers trained as local leaders of the boys' clubs. In the Northern and Western states, 11,478 local volunteers served as club leaders in 1916, and this number rose steadily each year to over 50,000 volunteers in 1927 (United States Department of Agriculture, 1917, 1919, 1928). These volunteers not only served as club leaders, but they also held community meetings, visited club members' plots, and worked to recruit new members (United States Department of Agriculture, 1917, p. 324). It is interesting to note that although corn clubs were exclusively open to boys until the 1920s, women were employed as leaders of corn clubs throughout their history (United States Department of Agriculture 1923; Knapp, 1910). Seaman Knapp wrote in 1910, "Get the teacher to organize the club...if the teacher is a woman, show her the general principles and explain to her; any woman in the country could be trained in twenty-four hours how to conduct boys' corn clubs" (p.5).

The Office of Extension Work outlined the procedure used in conducting boys' club work and stressed the importance of cooperation among extension, state agricultural colleges, other agricultural organizations, school officers and teachers. The work of boys' club work started at the local level with the enrollment and organization of members into local groups based on the agricultural project and proceeded with selecting a local leader, either volunteer or paid. The county extension agent was responsible for providing training materials, visiting club groups and plots, holding field meetings and instructional demonstrations, and coordinating club work with public school work. The club members were responsible for keeping accurate records, exhibiting their products, studying improved methods of farming, promoting conservation, attending club fairs and festivals, and submitting award applications. (United States Department of Agriculture, 1919, p. 462-463).

The relation of the county superintendent of education to the boys' corn club work was described in a circular published by the Alabama Agricultural Experiment Station in 1911. At the county level, the county superintendent of education was the leader and central figure of the corn club. If the school was very large, local corn clubs were allowed to be organized under the county club by providing the superintendent with a constitution and by-laws, list of elected officers, and teacher advisor. It was the superintendent's role to interest all teachers in the corn club movement and reach all boys in all sections of the county, even if they did not live on a farm but were willing to rent land. Once a list of all interested boys was compiled, the superintendent would hold a meeting in the fall (allowing for ample soil preparation time) to clarify the objectives and purposes of the corn club, adopt a county corn club constitution and by-laws, elect officers, and hold a discussion about better methods of corn growing led by the county agent. (Duncan, 1911)

A sample constitution for a county corn club, excerpted from "Program of County Organization Day for Boy's Corn Clubs" is shown below (Duncan & Kerlin, 1914, p.120 - 121)::

SUGGESTED CONSTITUTION FOR A COUNTY CORN CLUB

Article I - Name.

This organization shall be known as the _____ County Boys' Corn Club.

Article II - Purposes.

The purposes shall be to make farm life more attractive and the profession of farming more profitable; to assist the public schools in teaching the fundamental principles of agriculture in a more practical way; to aid the State College of Agriculture and the United States Department of Agriculture, through the Farmers' Cooperative Demonstration Club Work, in carrying information directly to the farms.

Article III - Members.

Boys only between the ages of ten and eighteen, on January the first of any given year, shall be reported as members.

Article IV - Officers and Committees.

The club shall have a president, vice-president, secretary-treasurer, and a committee on prizes, of which committee the county superintendent and the county demonstration agent shall be members.

Although this sample constitution states the maximum age for corn club members at eighteen, other clubs allowed members to be involved through age twenty-one (Duncan, 1911). In addition, the Office of Extension Work encouraged older boys up to the age of twenty-five to take part in corn clubs in 1922 and reported that this change raised the standard of work (United States Department of Agriculture, 1923).

In the suggested by-laws were specific rules governing corn club contests, including instructions on creating a plan of work, qualifications for prizes and exhibits, and organizing meetings (Duncan & Kerlin, 1914). Specific methods of calculating yield and profit also were provided:

By-law 6.

Each member shall gather the corn on his acre and weigh it all in the shuck. He shall record the number of pounds of corn in the shuck, then weigh out a hundred pounds of this corn, shuck same, shell and weight the grain, and then record the weight of grain shelled from the 100 pounds of corn in the shuck. This will represent the percent of grain. Such per cent, multiplied by the entire yield, and the result divided by 56, will give the yield in bushels

By-law 9.

In estimating profits, five dollars per acre shall be charged as rent of land. The work of each boy shall be estimated at ten cents per hours, and the work of each horse at five cents per hour. Manure shall be charged at the rate of \$2.00 for each two-horse wagon load. Commercial fertilizers shall be charged at their market value. No charge shall be made for leaves or muck hauled to the boy's acre by himself for the purpose of adding humus to the soil.

The boys not only needed to increase yield per acre in order to be successful, but they also needed to minimize production costs. In addition, the boys were to exhibit their corn at farmer's institutes and keep accurate records of their projects. All this was taken into account as part of the specified judging criteria for corn competitions (Duncan & Kerlin, 1914, p. 122):

By-law 12.

In awarding prizes, the following basis shall be used:

.....	(a) Greatest yield per acre	30 points
.....	(b) Best exhibit of ten ears	20 points
.....	(c) Best written account of crop	20 points
.....	(d) Best showing of profit on investment	30 points
.....		-----
	TOTAL	100 points

Prizes consisted of practical items, trophies, scholarships, diplomas of merit, and trips to Washington D.C. (United States Department of Agriculture, 1910, 1913, 1914). This method of awarding prizes was considered, along with personal visits to the boys' plots, the key to success of the corn club program (Duncan & Kerlin, 1914) and was indicative of the practical and educational value of the project (United States Department of Agriculture, 1911).

African Americans were also an important group of corn club members. In 1916, with the official designation of the Office of Extension Work in the South, "negro demonstration work, including boys' and girls' clubs for negroes", was specified as one of the five distinct lines of extension work (United States Department of Agriculture, 1917). African American corn clubs were systematized as separate projects in "Farm Maker's Clubs" and efforts greatly enlarged enrollments in 1918 (United States Department of Agriculture, 1917, 1919). The purpose of these clubs was to revolutionize the farming practices among African Americans (Clark, 1984). In addition, African American agents were hired throughout the southern states for demonstration and club work with a total of 272 African American agents employed by 1922 (United States Department of Agriculture, 1923).

Question 4 – What were the outcomes (benefits) of the corn clubs?

Boys' and girls' club work was considered the "most effective way" to cultivate the agricultural interests of young people, advance better agricultural practices, foster a sense of community, increase school attendance and performance, develop thrift and work ethic, promote team work, encourage healthy living, and increase enrollment in agricultural colleges (United States Department of Agriculture, 1917, p. 324). Boys' corn clubs developed personal leadership, community responsibility, good citizenship, and advanced farming principles more rapidly than any other method.

The boys' thorough study of corn led to improved success with other crops, such as cotton and potatoes (United States Department of Agriculture, 1911). These plots also served as a valuable lesson to the boys' fathers and other farmers in the community; the average yield of corn on a boy's plot was generally many times greater the average yield of the farm (The General Education Board, 1916). When yields were compared between corn clubs and other land, the differences were convincing to producers. Table 1 illustrates this phenomenon.

Table 1

Average Corn Yields (Bushels/Acre) Between Corn Club Plots and Similar Lands (The General Education Board, 1916, p.60).

State	Average Yield on Boy's Acre	Average Yield on Similar Lands
Alabama	62.3	17.2
Arkansas	49.5	22
Florida	38.58	8
Georgia	56.4	14
Louisiana	55.32	20.24
Mississippi	66.3	18
North Carolina	62.8	20
Oklahoma	48	22.63
South Carolina	68.79	18.5
Tennessee	91.46	35.5
Texas	38	24
Virginia	59.5	20

G. Harold Powell, Director of the Bureau of Plant Industry in 1910, recounted that only one year of experience in a corn club was needed to motivate a boy's father to accept improved farming methods, even if the father had previously declined to follow improved farming methods in the past (United States Department of Agriculture, 1911). Powell states, "It is also noteworthy that in many places where the farmer can not be reached primarily the Department has been able to reach him by enlisting his boy in the boys' corn clubs" (p. 82). For some farmers, corn clubs were the only convincing argument for change.

The boys' corn clubs undoubtedly spurred the improvement of corn production by testing new seeds and experimenting with farming methods to increase yields while minimizing expenditures. Yet, the benefits of crop production seem insignificant compared to the outcomes seen by the boys, their fathers, their community, and agriculture in general. Corn clubs helped young farmers realize the advantages of farming as an occupation, convinced older farmers to understand and accept better methods of production, and benefited the public school system by vitalizing rural education (United States Department of Agriculture, 1914). Agricultural literacy was increased on all levels, through public interest in the corn clubs, better attendance at farmer's institutes, and dissemination of agricultural research to farmers through their boys. In addition, the knowledge, skills, and training received from participation in boys' corn clubs often influenced boys to further their education at agricultural colleges (United States Department of

Agriculture, 1914). A teacher from Dorchester County, South Carolina explains the effect of corn clubs on agricultural literacy and the demand for agricultural education in schools in a letter entitled "What the corn club has done for my school":

This movement has been of great benefit to both school and community...It has helped to awaken boys to a greater interest in farming...The Corn Club was the beginning of what will be an agricultural school, which we have created a desire for, to contain about three acres of land to be used for demonstration purposes. It has also enabled us to have six good lectures on farms problems, and in this way has broadened the minds of the people in this community by introducing new thoughts and teaching something of what the world beyond their horizon is doing...and now they insist that a class in agriculture be taught in the school. (Haddon, 1912)

Furthermore, the knowledge, skills, and training received from participation in boys' corn clubs often influenced boys to further their education at agricultural colleges (United States Department of Agriculture, 1914). In one state, 218 club members entered the agricultural college in 1917 (United States Department of Agriculture, 1919). Not only did corn club participation increase a boy's desire to pursue a college education, it also provided a means to do so by awarding scholarships to state agricultural colleges to top corn club and farm maker's club members (Clark, 1984). The influence of corn clubs was truly seen in the personal and career success of the boys as adults. In fact, many of the county agents and extension specialists received their first training in agriculture through corn clubs (United States Department of Agriculture, 1918).

Conclusions and Implications

Corn clubs played an important role in improving agriculture at the turn of the 20th century. Farm boys learned improved farming practices and kept detailed records of their crop. Fathers learned from their boys. As a result crop yields increased and so did profits. Boys' clubs were the most effective way of convincing farmers of the value of new agricultural practices, while also educating the future generation of farmers.

But the ancillary educational benefits may have been even more important. Corn clubs increased the demand for agricultural education in public schools and greatly influenced the development of the home project method, which has evolved into today's Supervised Agricultural Experience. Through supervised projects, the boys learned to think critically and analyze their situations. In addition, these projects fostered entrepreneurship skills and provided recognition for the boys' efforts. The corn clubs introduced real life subjects into the schools, and through the use of advanced scientific methods, showed the application of science and mathematics. In addition, corn clubs tied learning to career skills and competition and the success illustrated the value of integrated, practical education. Basically corn clubs breathed new life into a stuffy curriculum. And some may argue the competition was even healthy.

The organization and constitution of corn clubs also influenced the development of 4-H and FFA. Most corn clubs had a formal structure that included a constitution, bylaws and officers. The members also learned correct parliamentary procedure. Formats for record keeping and award applications were also developed. Similarities in the structure of corn clubs and other youth agricultural organizations are apparent. One could easily draw connections between corn

club competitions and today's agricultural education and extension programs. Examples include corn club contests and FFA Proficiency Awards, corn club record keeping and the current 4-H record book competitive system, and the All-Star Corn Club and the FFA's American Star Awards.

The corn club movement was promoted by various groups such as universities, public schools, agricultural societies, state departments of agriculture, the USDA and philanthropic groups. These groups often worked together to promote corn clubs. Perhaps cooperation among the various groups involved in agriculture today could lead to improved programming in agricultural and extension education. Discussions among 4-H, FFA, and other agricultural organizations may lead to innovative ideas on how to reach more youth throughout the nation.

The competitive nature of corn clubs could be utilized today by agriculture teachers. There could be competition among students with square foot gardens, with flats in the greenhouse, or even on school land laboratories where they exist. In addition, conducting school agricultural fairs to exhibit student projects for the community could be used to share the agricultural knowledge with other students and adults. The public could be informed about controversial issues such as agricultural pollution and genetically modified crops through student displays and demonstration work. Furthermore, this work may increase students' interest in pursuing a college education and choosing a career in an agricultural field.

Today in agricultural and extension education, this method of experiential learning can still be utilized effectively in many areas other than just corn production. The original corn clubs were designed to not only better educate students, but also to better educate farmers who were less likely to accept new ideas without first seeing the benefits themselves. Agricultural teachers and extension agents can use these same methods to reach students and producers today. Furthermore, the history and success of the corn club movement emphasizes the importance of a renewed commitment to the integrated approach for agricultural education that includes formal instruction, supervised experience, and student competitions and recognition.

References

- Alabama Department of Education, (1910). *Information in Regard to Corn Clubs for Alabama Boys*. Montgomery, AL:
- Armstrong, L. O. (1929). *The History of Agricultural Education in North Carolina*. Unpublished Master's thesis, North Carolina State University, Raleigh.
- Benson, O.H. (1912). *Organization and Instruction in Boys' Corn-Club Work*. Washington, D.C.: United States Department of Agriculture, Bureau of Plant Industry.
- Borg, W. R. & Gall, M. D. (1983). *Educational research (4th ed.)*. New York, NY: Longman.
- Clark, J. W. (1984). *Clover all over: North Carolina 4-H in action*. Raleigh, NC: North Carolina State University.
- Crosby, D. J. (1904). *Boys' Agricultural Clubs*. Washington, DC: United States Department of Agriculture, Office of Experiment Stations.
- Davis, B. M. (1911). Agricultural Education: Boys' Agricultural Clubs. *The Elementary School Teacher*, 11(7), 371-780.

- Duncan, L. N. (1911). *The relation of the country superintendent of education to the boys' corn club work. How to organize a club* (Alabama Polytechnic Institute, Alabama Agricultural Experiment Station Circular No. 9), Opelika, AL: Post Publishing Company.
- Duncan, L. N. & Kerlin, I. B. (1914). *Program of county organization day for boys' corn clubs* (Alabama Polytechnic Institute, Alabama Agricultural Experiment Station Circular No. 30), Opelika, AL: Post Publishing Company.
- Fraenkel, J. R. & Wallen, N. E. (2009). *How to design and evaluate research in education (7th ed.)*. New York, NY: McGraw-Hill.
- Graham, A.B. (1941). Boys' and Girls' Agricultural Clubs. *Agricultural History*, 15(2), 65-68.
- Haddon, C. B. (1912). *Some Results of the boys' corn club work in South Carolina* (Clemson Agricultural College, South Carolina Agricultural Experiment Station Circular No. 7). Anderson, S.C.: Oulla Printing & Binding Co.
- Knapp, B., & Martin, O.B. (1913). *Boys' Demonstration Work*. Washington, DC: United States Department of Agriculture, Bureau of Plant Industry.
- Knapp, S. A. (1910). *The mission of cooperative demonstration work in the south* (United States Department of Agriculture Circular No. 33). Washington, D. C.: Government Printing Office.
- Lincoln, Y. S. & Guba, E. G. (1985). *Naturalistic inquiry*. Newbury Park, CA: Sage Publications.
- McCormick, V. E. & R. W. (1984). *A. B. Graham country schoolmaster and extension pioneer*. Worthington, OH: Cottonwood Publications.
- National 4-H Hall of Fame. Retrieved October 2, 2010, from <http://www.nae4ha.com/hof/wotwell.html>.
- National Research Council (1988). *Understanding Agriculture: New Directions for Education*. Washington, DC: National Academy Press.
- Nolan, A. W., & Greene, J. H. (1917). *Corn Growing: A Manual for Corn Clubs*. Chicago, IL: Row, Peterson, and Company.
- The General Education Board. (1916). *The General Education Board: An Account of Its Activities*. New York, NY: The General Education Board.
- The National Council for Agricultural Education (1909). *Reinventing agricultural education for the year 2020*. Retrieved October 2, 2010 from <http://www.teamaged.org/council/index.php/goals>.
- True, A. C. (1915). *Cooperative Agricultural-Extension Work* (United States Department of Agriculture Circular No. 47). Washington, D. C.: Government Printing Office.
- True, A. C. (1929). *A history of agricultural education in the United States 1785 - 1925* (United States Department of Agriculture Miscellaneous Publication No. 36). Washington, D.C.: Government Printing Office.
- United States Department of Agriculture. (1851). *Report of the commissioner of patents, for the year 1850. Part II. Agriculture*. Washington, D. C. Office of Printers to House of Representatives.
- United States Department of Agriculture. (1907). *Annual reports of department of agriculture for the year ending 1906*. Washington, D. C.: Government Printing Office.
- United States Department of Agriculture. (1908). *Annual reports of department of agriculture for the year ending 1907*. Washington, D. C.: Government Printing Office.
- United States Department of Agriculture. (1909). *Annual reports of department of agriculture for the year ending 1908*. Washington, D. C.: Government Printing Office.

- United States Department of Agriculture. (1910). *Annual reports of department of agriculture for the year ending 1909*. Washington, D. C.: Government Printing Office.
- United States Department of Agriculture. (1911). *Annual reports of department of agriculture for the year ending 1910*. Washington, D. C.: Government Printing Office.
- United States Department of Agriculture. (1912). *Annual reports of department of agriculture for the year ending 1911*. Washington, D. C.: Government Printing Office.
- United States Department of Agriculture. (1913). *Annual reports of department of agriculture for the year ending 1912*. Washington, D. C.: Government Printing Office.
- United States Department of Agriculture. (1914). *Annual reports of department of agriculture for the year ending 1913*. Washington, D. C.: Government Printing Office.
- United States Department of Agriculture. (1915). *Annual reports of department of agriculture for the year ending 1914*. Washington, D. C.: Government Printing Office.
- United States Department of Agriculture. (1917). *Annual reports of department of agriculture for the year ending 1916*. Washington, D. C.: Government Printing Office.
- United States Department of Agriculture. (1919). *Annual reports of department of agriculture for the year ending 1918*. Washington, D. C.: Government Printing Office.
- United States Department of Agriculture. (1920). *Annual reports of department of agriculture for the year ending 1919*. Washington, D. C.: Government Printing Office.
- United States Department of Agriculture. (1923). *Annual reports of department of agriculture for the year ending 1922*. Washington, D. C.: Government Printing Office.
- United States Department of Agriculture. (1928). *Annual reports of department of agriculture for the year ending 1927*. Washington, D. C.: Government Printing Office.
- Wessel, T. (1976). Agriculture, indians, and American history. *Agricultural History*, 50(1), 9-20.

**A Non-Traditional Route to Teacher Certification:
Testimonies from Four Teacher Aspirants in Agricultural Education**

J. Shane Robinson

Assistant Professor, Oklahoma State University

John J. Blackburn

Graduate Assistant, Oklahoma State University

Marshall A. Baker

Graduate Assistant, Oklahoma State University

Abstract

The purpose of this qualitative, descriptive study was to assess the factors that led non-traditional students (i.e., those who did not participate in secondary agricultural education programs) to the agricultural education teaching major per the PE fit theory. The study consisted of four students who and were at varying stages of their academic preparation. Findings of the study indicated that these participants were motivated to pursue an agricultural education teaching degree because of their passion for agriculture and youth and affinity for people and the job. Parents and friends were the biggest influences on these individuals' decisions. Their greatest perceived strengths were their content knowledge, leadership skills, and ability to persevere, and their greatest perceived limitation was their lack of experience in a secondary agricultural education program. Because these findings are more "subjective" and "personal" (P) in nature, future research should seek to investigate more objective measures of what is demanded from these teachers in the workforce (i.e., environment – E). Specifically, officials hiring teachers should be queried to determine which phases of human capital are most important. Finally, these students should be tracked and assessed further on their PE fit so that adjustments can be made if needed.

Introduction

What inspires students to teach agriculture? Pre-service teachers often indicate that a former teacher was their biggest influence in choosing to become a professional educator. Park and Rudd (2005) noted, "students spend hours with the agriculture teacher developing supervised agricultural experience programs, preparing for career development events, and working on FFA activities after school" (p. 82). Similar results have been reported in other sectors of career and technical education. Wright and Custer (1998) reported the most influential factor in encouraging students to become a technology education instructor was encouragement from the students' high school industrial arts or technology teacher. Automotive teachers were found to be a major influence on the career choice of automotive students (Frisbee, Belcher, & Sanders, 2000). It is during these times of interaction that students recognize what it means to be a teacher. These experiences accumulate, and some students begin to emulate their teacher (Park & Rudd, 2005; Stevenson, 1987).

However, what about students desiring to be agricultural educators who did not participate in agricultural education or FFA at the secondary level? What influences and motivates them to

become agricultural education teachers? Although this group may be in the minority of pre-service agricultural teachers (Roberts, Greiman, Murphy, Ricketts, & Harlin, 2009), it is important to understand why they wish to teach. Kantrovich (2007) noted a shortage of agriculture teachers as early as 1965. This shortage has continued through at least 2006 and has the “potential to reach epidemic proportions if we are unable to recruit additional students into the field of agricultural education . . .” (p. 37). Compounding the issue of agriculture teacher shortages is the 10 X 15 initiative. This initiative proposes that by “2015 there will be in operation 10,000 quality agricultural science program serving students . . .” (National FFA Organization, p. 8). Also, a portion of the shortage of agriculture teachers can be explained by the fact that in any given year between 30 and 40 percent of newly certified teachers do not enter teaching. Institutions certifying agriculture teachers must recruit potential teachers with the understanding that not all of the graduates may enter the teaching profession. Therefore, institutions must recruit as many potential teachers as possible in an effort to offset the shortage.

Roberts et al. (2009) reported that nearly 13 percent of all student teachers in agricultural education had not been enrolled in secondary agriculture courses previously. Their study found that a higher proportion of those students intended to teach than almost all other groups. The only group of pre-service teachers with a higher intention to teach was those who participated in seven or eight semesters of agriculture at the secondary level (Roberts et al., 2009).

Since these students did not participate in secondary agricultural education, other factors regarding career choice must be at play. Prior research has listed several factors that influenced the career choice of students. Esters and Bowen (2005) reported that among urban agriculture students, parents/guardians and friends were the most influential in determining their choice of career. Conroy, Scanlon, and Kelsey (1998) assessed job choice among students in rural schools and discovered the majority who chose an agricultural career had their father present in the home and were from lower socioeconomic status. Among African-American and Hispanic graduates from land-grant colleges, choosing an agriculturally related profession was not related to whether or not they were in high school level agriculture courses (Jones & Larke, 2001). It was also determined that the father’s occupation had an influence on the career choice of African-Americans and Hispanics. Specifically, if the father’s occupation was in agriculture, the students were more likely to choose an agriculturally related career (Jones & Larke).

Conceptually, this study was framed using the career choice theory of person-environment (PE) fit. PE fit takes into consideration a person’s skills and abilities as well as the demands of the environment (Osipow, 1990). Caplan (1987) stated that, “Organizations wish to select persons who will best meet the demands of the job, adapt to training and changes in job demands, and remain loyal and committed to the organization” (p. 248). “PE fit is changed by altering P (e.g., abilities and aspirations), E (e.g., job demands and rewards), or some combination” (Caplan, 1987, p. 248). As such, it is important that these students build their human capital (Becker, 1964) (i.e., education, skills, training, and experiences) because employers seek individuals who have the human capital needed to “fit” their job. Caplan (1987) stated that, “Prospective employees want to find organizations which make use of their particular abilities and meet their specific needs” (p. 248).

PE fit can be either subjective or objective. “Subjective fit is that which is perceived by the target person – that is, the employee. Objective fit, by definition, is free of the bias of human

perception” (Caplan, 1987, p. 251). Kezar (2001) advanced the PE fit model to help individuals recognize and match their human capital to the needs of the organizations in which they are seeking employment.

Lindholm (2003) identified four levels of environmental fit that exist within organizations. Person-vocation fit “refers to congruence between a person’s choice of occupations and his or her self-concept” (p. 128). Person-job fit refers to the demands of the job and whether or not the individual believes he or she has the skills necessary to perform the job well. Person-organization fit refers to how the person’s “values, interests, needs, and abilities” (p. 128) match up with the job and “climate” of the organization. Person-work group fit refers to how the individual believes he or she will be accepted by co-workers currently employed within the organization.

Osipow (1990) stated that, generally, people seek good matches of fit between their human capital and the descriptions and rigor of the job. This “match” is influenced mostly by parents and the “reinforcement and resources [they] provide” (p. 124). In some cases, where fit is not as strong, the individual can tailor or adjust his or her abilities to “fit” the industry better (Lindholm, 2003).

A number of studies specifically identified the job demands of agricultural educators. Miller, Kahler, and Rheault (1989) identified five common performance areas for effective agriculture teachers consisting of productive teaching behaviors, organization, structure classroom management, positive interpersonal relationships, professional responsibilities, and personal characteristics. Roberts and Dyer (2004) listed forty characteristics of an effective agriculture teacher that were categorized into the eight areas. These areas consisted of instruction, FFA, SAE, community relations, marketing, professionalism, program planning/management, and personal qualities. Among the characteristics, those receiving 100 percent agreement by the panel included effectively plans instruction, effectively evaluates student achievement, has a sound knowledge of FFA, actively advises the FFA chapter, effectively prepares students for Career Development Events (CDEs), and effectively manages, maintains and improves laboratories.

Heckman (2000) stated that as people acquire skills, they become more competent in general. Heckman proposed that the return on human capital is higher for “younger” people than it is the “older” people. This proposition would seem to have implications for pre-service teachers who were not able to participate in secondary agricultural education programs. From an employability standpoint, how do “non-traditional” students (those who have a lack of secondary FFA and SAE experiences) perceive their “fit” in the agricultural education teaching profession based upon their human capital?

Purpose of the Study

The purpose of this qualitative, descriptive study was to assess the factors that led non-traditional students (i.e., those who did not participate in secondary agricultural education programs) to the agricultural education teaching major. The following research questions guided the study.

1. What factors motivated non-traditional students to choose secondary agricultural education as a major?
2. What personal fit attributes (P) do non-traditional students believe they possess that will enable them to be effective as teachers?
3. What environmental fit attributes (E) do students perceive as important to teach secondary agricultural education?

Methods

This qualitative, descriptive study consisted of open-ended questions in face-to-face interviews with four “non-traditional” pre-service agricultural education majors. Qualitative, descriptive studies “offer a comprehensive summary of an event in everyday terms of those events” (Sandelowski, 2000, p. 337). This method of data collection was deemed appropriate because of the small sample size of pre-service teachers who participated in the study (Dooley, 2007).

The data for this study were collected through in-depth, face-to-face interviews. The researchers served as the instruments for the study (Guba & Lincoln, 1989). Each interview consisted of a highly structured, 21-item interview protocol (Dooley, 2007) (Table 1) that was developed by the researchers based on the PE fit theory of career choice (Caplan, 1987). To establish credibility of the protocol, the researchers asked two professors in the department of Agricultural Education, Communications and Leadership at Oklahoma State University to assess the questions for completeness and consistency in conjunction with the study’s purpose. Based on those suggestions, minor adjustments were made to the instrument.

Table 1

<i>Interview Protocol</i>		
	Questions	PE Category ^a
1.	Describe where you grew up.	P
2.	Tell me about your school experiences as a high school student. In what clubs and organizations were you involved?	P
3.	What led you to your interest in agriculture? What former experiences do you have in agriculture?	P & E
4.	What experiences do you have working with youth?	E
5.	Was agricultural education offered at your school?	P & E
6.	How were you exposed to agricultural concepts in high school?	P
7.	Where were you exposed to agricultural education that sparked your interest in the profession?	P
8.	When did you decide that teaching agriculture was what you wanted to do?	P
9.	Who were your biggest influences regarding your career choice?	P

10. Why did you choose to major in agricultural education? P

Table 1 (Continued)

	Questions	PE Category ^a
11.	What do you believe is the purpose of agricultural education?	P & E
12.	Why do you think you will be a good agriculture teacher?	P & E
13.	What do you see as your greatest strength as a future teacher?	P & E
14.	What do you see as your greatest limitation or weakness as a future teacher?	P & E
15.	What inhibitions/fears do you have about being a teacher?	P & E
16.	What barriers will you have to overcome to be an effective teacher?	E
17.	What do you believe is the most interesting thing about teaching agriculture?	P
18.	In what type and size of program do you hope to teach?	P & E
19.	What were your career plans before agricultural education?	P
20.	Do you feel accepted into the “community” of agricultural education? Why or why not?	P
21.	How long you plan to teach?	P
22.	If a principal asks why you should be chosen over a more traditional applicant, what would be your response?	E

Note. ^aP = Personal fit; E = Environmental fit

For the purpose of this study, the researchers intentionally selected “non-traditional” pre-service agricultural education teachers who were attending Oklahoma State University. As such, this study employed a purposive sampling technique. According to Ary, Jacobs, and Razavieh (1972), “purposive sampling is a nonprobability sampling technique in which subjects are judged to have the sought after characteristic are included in the sample” (p. 180-181). As such, these “sought after” participants received an e-mail from the researchers asking for their participation in the study. Once confirmed, a date was set and the interview was conducted. All interviews occurred in a neutral office on campus at Oklahoma State University. The interviews each lasted approximately one hour in length and were tape-recorded for transcribing purposes.

Once data were transcribed verbatim, member checks were conducted to establish credibility (Guba & Lincoln, 1989). Specifically, each transcription was submitted to its respective participant, via e-mail, in an effort to verify that the researchers had captured the essence of the interview accurately. Additionally, to help the researchers maintain credibility, notes were taken during each interview session, which assisted the researchers in validating emic perspectives (i.e., insider’s “intuition”) (Merriam, 1998).

For dependability, the researchers each developed an audit trail (Guba & Lincoln, 1989) based upon their analysis of the data. Each researcher documented the transcriptions for dependability

and credibility (Trochim, 2006). Then, the researchers met and discussed their findings to confirm their stances emic and etic (Patton, 2002) perspectives.

Based on the documented transcriptions, the researchers analyzed the data line-by-line (Patton, 2002) to develop themes (Dooley, 2007). Once themes were constructed, memos were established. Memoing is a technique used to allow the researchers to summarize findings into thoughts and sentences based on the transcribed data as well as the researcher's intuition (i.e., emic perspective) (Gardner, 2008).

Findings

The purpose of this qualitative, descriptive study was to assess the factors that led non-traditional students (i.e., those who did not participate in secondary agricultural education programs) to the agricultural education teaching major. The four students who participated in this study consisted of two males and two females. To protect the identity of the participants, pseudonyms were used. As such, "Ed" was homeschooled as a child. He has completed his student teaching experience and graduated from Oklahoma State University with an agricultural education degree. He is actively seeking employment as an agricultural education teacher and is currently working on a master's degree in another technical area. "Sandra" has completed her course of study in agricultural education and is currently experiencing the student teaching internship with the hope of securing employment in spring 2011. "Keri" and "Tom" are both junior-standing students in agricultural education. And, both are from out of state. They will student teach in fall 2011. Direct quotes from the interviews include the participants' pseudonyms and corresponding line number(s) from the transcription as a means of establishing thick, rich descriptions from the audit trail.

Theme: Passion for Agriculture and Youth

All four students expressed that even though they had never been involved in a secondary agricultural education program, they had a "love of agriculture." Each of the students had different agricultural backgrounds, most of which were not production agriculture. Additionally, all four students expressed their deep desire to impact youth. Each student recognized the need for agriculture. As such, the desire to educate and work with youth was apparent throughout the study.

Ed stated, "I've always had a passion for helping people." This motivation escalated once he attended the university. He shared further, "I love agriculture, but didn't want to farm." Keri said, "I want to be an advocate for agriculture and, although I'm not a traditional student and I didn't grow up around it, I'm on fire about it." She noted that her passion for agriculture sets her apart, "Traditional students may get in their comfort zone and they'll just start teaching in their comfort zone. They may have the experience, but I have the book knowledge, teaching skills, and passion."

Tom expressed his passion for helping educate and develop youth. He stated passionately, "I am going to teach you how to survive in life." In order to accomplish this, Tom felt that students needed information in some context, and his preferred context was agriculture – "you can teach math, you can teach science, and you can teach English, but you have to tie it to something and something that everyone knows like trees, plants, and animals." This idea led to Tom's personal interest in individual sustainability that led him to agriculture education. He shared that, "people

are in the mindset of the past” (302), but agriculture is changing rapidly. Tom felt that people should be more in touch with their food and how it is raised.

Sandra shared in Tom’s idea by stating, “People in the city are completely ignorant of agriculture. They have no idea, no idea of the value it holds for this country. I can say that because I was one of those people once” (90-92). Keri added, “I want to educate the general public about agriculture, be an advocate for agriculture, and I feel that agricultural education gives me a way to dabble into everything.” She elaborated, “I would love to be an advocate for non-traditional agricultural students or people in urban communities, educating them about agriculture and how important it is.”

Theme: Affinity for People and the Job

Each of these students noted the friendliness of other students in the College of Agriculture and other people involved in agriculture generally. As such, these individuals had an appreciation for the genuineness of people who are involved in agriculture.

Tom said pointedly, “The people are really one thing that drew me to Ag. How receptive, open, and friendly they are. It’s a different kind of people, and that’s something I like being around” (69-72). Sandra agreed. “The people in Ag are just so friendly. They’re so nice. They’re so, ‘here’s my life story.’ Listening to their stories and talking about their Ag teachers, I was like ‘well, maybe one day I could be that Ag teacher’” (346-39).

Ed stated that his “love” of agriculture grew basically out of a “hatred” for farming. He sees teaching as a more secure position, whereas, farming was a gamble. Also, he perceived teaching agriculture as a more stable job in terms of time commitment. He stated matter of factly, “I decided to go Ag. Ed. It’s an 8 to 5 [hour per day], 12-month contract.” Tom noted that part of his perceived enjoyment of being a future agriculture teacher is the sheer challenges associated with being an effective teacher. He stated, “To me, teaching is one of the most challenging things you can possibly do if you do it the right way.” Sandra echoed his sentiments. “It [teaching agriculture] is fascinating to me. I could never learn enough about agriculture. It’s all fascinating!” (274-276). Tom iterated that observing other agriculture teachers motivates him to join the ranks. He stated, “Seeing the passion for the people who teach Ag Ed because they love what they do is something that makes you want to stay [in the teaching field]” (473-475).

These teachers all noted pertinent individuals who pushed them to pursue a teaching degree. All noted that their parents were big supporters. Additionally, Tom recognized that his dad and a former college faculty member at the junior college he attended were his two biggest advocates in motivating him to be an agriculture teacher. “He [dad] was actually the whisper in my ear the whole time saying, ‘don’t listen to what everyone else is saying you should be, do what makes you happy.’” He elaborated that his parents instilled in him to, “do what you can have an impact doing because you’ve been put here for a purpose and so find your purpose.”

Theme: Perceived Strengths

These participants believe that they have an advantage over their “traditional” counterparts because they have not been pre-disposed to any of the content or the program. As such, they believe they have no preconceived notions about what agricultural education “is.” As such, they

are more apt to learn the material at the university better and with more intensity because it is new and novel to them.

Participants noted that, through hard work and dedication, they have acquired more knowledge than their peers. Sandra stated, “I think my greatest strength will be the knowledge that I have gained [in college] (188) and my patience and ability to work with youth, and understanding that they’re all different” (191-192). Tom explained that because he was not raised in agriculture, he has developed a greater felt need to learn information. This eagerness to learn, referred to by Tom as “life-long learning,” is an advantage of a non-traditional agricultural educator. He noted that at times it is fun to enter a setting with an attitude that “we can learn this together.” Sandra confirmed confidently, “What I don’t know I will find out one way or another” (190). Keri added that she believes her lack of experience can actually be a positive attribute for her because she has to work that much harder at learning the content. She said, “I’m new at this and I have to enrich myself in all of this because I’m learning every single day. All of it is new to me.”

Another noted advantage was participants’ goal orientation, involvement, motivation, and academic success. Keri and Tom stated that their involvement in leadership was their greatest attribute. Tom served as a national officer in another career and technical organization as a high school student. Keri is working to receive a leadership minor at the university as part of her undergraduate degree and serves currently as an ambassador for the College. She stated plainly, “I’ve been involved in a leadership role all throughout my life. Leadership is kind of my thing.” Sandra was motivated to complete a double major and did so while remaining “in the top 10% of her class.”

Theme: Perceived Limitations

Participants revealed that not having experienced a secondary agricultural education program was their greatest limitation. As such, they recognized that their skills were perhaps lacking when compared to their “traditional route” colleagues in regard to livestock exhibition and FFA speech preparation in particular. Students were concerned that not being in the FFA would restrict their abilities as future agriculture teachers and they might be less credible to their students than they would prefer.

Tom admitted not coming from a production agriculture setting takes away from his confidence and credibility. He stated,

I think you have to establish a certain degree of credibility in the classroom or the kids are just going to tear you up. You know, some kid knows a lot about show steers, and you start talking about show steers, and you say one thing that is not correct, and they are going to eat you alive. (288-292)

Keri asserted that this building of credibility begins in the teacher education program. She shared that, “I have to prove myself and make a name for myself before anyone is accepting of me.” She noted relevant hand-on experience in agriculture is her limitation, and she looks to her teacher education program to fill that gap by the time she graduation.

Another common limitation was related to individual’s pre-developed opinions of non-traditional agriculture teachers. Ed shared that, “[Agricultural Education] is a very unfriendly profession in my opinion. It is dog eat dog, unless you know the neighboring teacher and can get your foot in

the door.” During a course assignment, Ed was asked to teach a three-day lesson to a high school agriculture class. At the end of the three days the teacher made a remark that shocked Ed to the core.

He told me that since I was homeschooled I would never know enough to be an Ag teacher. That made me so mad! So, I went with a passion through Ag Ed the entire way. I can honestly say if I ever see that Ag teacher again, I would probably spit in his face and pull out my degree and show it to him.

Though this experience fueled Ed’s desire to teach agriculture, he still struggles with this commonly held belief from the teaching community. Keri had a similar circumstance whereby a faculty member informed her that she would have difficulty securing employment as a teacher due to her background. She said,

I wouldn’t say I was discouraged not to participate in Ag Education, but I was informed it would be a struggle for me. I was at a high disadvantage because I’m non-traditional, I am a female, and I’m from out of state.

Each participant noted that the lack of FFA and SAE experiences serve as a limitation. Sandra commented that, “training the kids for CDEs is what I really worry about” (246), and that “when I tell people my background and where I grew up, all they hear is ‘No FFA!’” Ed admitted that, “there were several stumbling blocks along the way [especially] just finding out more on the FFA part of it and the SAE side of it. I had never heard of SAE. I never heard of record keeping.” In regard to her lack of FFA knowledge, Sandra’s greatest fear is, “students will not get to participate because of something I did.”

FFA and SAE knowledge was noted repeatedly as a potential limitation. Tom shared his biggest limitation is, “that I don’t come from a production agriculture setting.” Sandra noted that skills such as fitting show animals are sources of anxiety. She admitted to thinking, “I can’t do this. I can’t handle it. These kids are going to look at me and think you are some kind of idiot because you can’t blow dry a cow right.” Tom described a class situation where an instructor was asking students to identify the area in which students are limited. He shared his realization that, “I’m raising my hands for everything. This is probably funny to most people.” Sandra added, “Every day I have questioned whether or not I have chosen the right major because I don’t have that FFA experience. Every day I question whether I will be able to do this or not and that is so scary, it’s so scary!” (350-352).

Theme: Purpose of Agricultural Education

Participants identified that the purpose of agricultural education was to educate the public about agriculture further and to grow and develop future leaders in agriculture and society as a whole.

Ed explained that the purpose of agricultural education was to teach students about “the world of agriculture, the changes of agriculture, the diversity of agriculture, but also to show students where their niche is if they want to pursue agriculture as a career.” Ed had a distinct belief that agricultural education has deviated too far from the original purpose of promoting agriculture. He stated that, “FFA is slightly overdone”, and explained that it shouldn’t be about who spends the most money on a show animal, but who gleans the most learning from agriculturally-related experiences.

Keri admitted that she struggles to define her career major to friends and family. Being from the “city” makes it difficult to find a “working definition” of what is agricultural education. Ed was more profound in his ability to communicate its purpose. He stated that the purpose of agricultural education is “to educate them [secondary students] about the world of agriculture, the changes of agriculture, the diversity of agriculture, but also, show them where their food, fiber, and natural resources come from.” He added that another purpose of agricultural education was to teach people to be self-sustained and “know how to grow a garden.”

Sandra explained that agricultural education exists “because agriculture, no matter how small or large you think it is, is absolutely vital – vital to the success of this country.” Tom took a more holistic approach to answering the question. He confirmed, “The whole point of education is to develop from the next step and to teach them [secondary agricultural education students] how to survive in society” (252-253).

Theme: Ideal Program Type

Participants shared their preference to work within a well developed, multi-teacher department in order to grow and develop under a more experienced educator. The participants preferred both urban and rural settings.

Ed shared that his best-case scenario would be, “an urban, two-teacher department that has community and administrative support.” When asked why Ed preferred a more urban setting, he responded that, “75% of those students don’t know where milk comes from. With the urban community, if you can get those kids roped into your program, you have a little bit more attentive audience.”

Sandra stated, “My ideal school is somewhere where I am welcomed into the community, where I have that community support, the school support, [and] administrative support. I would like to see more agriculture in urban settings” (313-315). She noted that, “I would be uncomfortable going to a rural setting where there is such a successful chapter, just because those are big shoes to fill and there are going to be a lot of expectations.”

Keri explained that she desired to begin her teaching career in a multi-teacher department because, “it is important for me, important for the students, and although I am going to work really hard, I’m going to have questions when I teach and I would like to have someone older than me to mentor me.” She preferred a more rural setting in order to gain additional experience in the area of production agriculture, and felt that, “I need to go to the place where I will learn the most.” Keri also shared that after gaining experience, she would “love to go back home [to her home state] and start an Ag program. Or, even to start an Ag Program in New York or something.” She reasoned that it would be interesting to help students, like herself, who didn’t grow up in agriculture.

Tom stated simply that he wanted to work in a “stronger” program with multiple teachers. He shared, “I’m not picky as long as I’m in a place where I feel like I can make a difference. He did note he prefers a rural lifestyle but concluded by sharing that he “sees the pros and cons to both.”

Conclusions

The purpose of this qualitative, descriptive study was to assess the factors that led non-traditional students (i.e., those who did not participate in secondary agricultural education programs) to the agricultural education teaching major per the PE fit theory. This study revealed that these students were motivated to pursue an agricultural education teaching degree because they have passion for agriculture and youth, affinity for people involved in agriculture and the job, and a desire to bring about agricultural literacy and awareness. Specifically, these students have a unique and enlightened sense of agriculture because they are learning the content for the first time. Further, these students have an affinity for agriculture. They perceive agriculture as “cutting edge” and innovative. They noted that agriculture people are overly nice and helpful. Yet, once these students enter the agricultural education major, they realize that the profession is competitive and fraternal by nature. As such, they are forced to adjust and adapt their P and E to “fit in” (Caplan, 1987; Lindholm, 2003).

Because these students have not been pre-disposed to agricultural education, they have a greater felt need to learn and grow within the pre-service program. Therefore, these students are not as concerned about their technical agriculture knowledge. Rather, they are more concerned about their lack of FFA knowledge and SAE experiences, which are major criteria for teaching agriculture (Roberts & Dyer, 2004). Explaining the purpose of agricultural education to others is difficult for these students. Understanding policy-driven information related to FFA (i.e., completing FFA record books, training students to compete on CDE teams) was also an area of concern. In all, these non-traditional students are passionate about agricultural education. They have a deep desire to work with youth and teach them about agriculture and its importance in the world.

Parents, faculty members, and other students in the College of Agriculture were the greatest influences on these individuals becoming agricultural education majors. The fact that parents were highly influential resonates with previous research (Conroy et al., 1998; Esters & Bowen, 2005; Jones & Larke, 2001). Additionally, these students were drawn by their perception of the openness, warmth, and acceptance of the individuals involved in agriculture.

Limitations

This study was limited to “non-traditional” students (those who had a lack of secondary agricultural education experience). As such, readers are cautioned not to generalize the findings past this population. Also, this study assessed only pre-service teachers’ perceptions (subjective fit) and not the perceptions of officials (objective fit) who hire teachers (i.e., secondary administrators). Lastly, this study was limited to four pre-service teachers. This limitation was due to the small number of “non-traditional” students, as defined by this study, who attend this institution currently.

Recommendations for Future Research

Although pre-service teachers’ perceived PE fit is important from a recruitment and retention standpoint, research should also be conducted with officials who hire agriculture teachers (i.e., principals) to determine “actual” fit. Specifically, what characteristics and experiences are most important when employing a secondary agricultural education instructor? Research should assess this phenomenon in an attempt to prepare current and future students better. Currently, alternatively certified teachers in agricultural education are being employed to fill vacancies of

teacher shortages; yet, these teachers have no pedagogical training (Robinson, 2010). So, from an employability perspective, are life experiences or pedagogical skills more imperative to hiring officials? Further, these individuals should be assessed throughout their educational careers to determine their level of success in securing employment as agriculture teachers as well as their satisfaction, loyalty, and commitment to the job (Caplan, 1987).

Recommendations for Practice

Attempts should be made to assist pre-service teachers in understanding their PE fit in the teaching profession better. Once identified, these students should be encouraged to “adjust” their skills, education, and experiences (i.e., human capital) in an effort to “fit” their skills to the needs of the workplace (Lindholm, 2003). Also, attempts should be made to connect non-traditional students with more intentional field-based experiences. Because these students have no former experiences, programs that “fit” non-traditional teachers’ needs best should be identified, especially as it relates to student teacher placement. Specifically, if students desire to teach in multi-teacher programs in urban areas, then attempts should be made to fulfill these needs more intentionally. Further, teacher educators should be cautious when describing the profession to non-traditional students so as not to “turn off” students who are more “open” and “creative” in their thoughts of what agriculture “could be.”

Implications

Establishing PE fit is an ongoing phenomenon. As such, it is important for teacher educators to purposely consider each pre-service teachers’ needs. Do pre-service teachers know their PE fit? Does their “fit,” or lack thereof, have implications for their satisfaction with their job? Further, how does PE fit relate to securing employment and job retention in agricultural education? It would appear that bright, motivated, passionate individuals could secure jobs regardless of their former experiences or lack thereof. It would also seem obvious that individuals who are satisfied with their job have “good” PE fit and would likely be more apt to remain in the teaching profession longer. Likewise, it would be assumed that those individuals who are less satisfied with their jobs have “poor” PE fit and would thus be more apt to leave the profession. Helping pre-service teachers understand their PE fit early in their academic careers could have big implications for recruitment and retention efforts of teachers, as well as teacher quality.

References

- Ary, D., Jacobs, L. C., & Razaviah, A. (1972). *Introduction to research in education (5th ed.)*. Orlando: Holt, Rinehart, and Winston, Inc.
- Becker, G. (1964). *Human Capital: A theoretical and empirical analysis with special reference to education*. Chicago: The University of Chicago Press.
- Caplan, R. D. (1987). Person-environment fit theory and organizations: Commensurate dimensions, time perspectives, and mechanisms. *Journal of Vocational Behavior*, 31, 248–267.
- Conroy, C. A., Scalon, D. C., & Kelsey, K. D. (1998). Influences on adolescent job choice: Implications for teaching career awareness in agricultural education. *Journal of Agricultural Education*, 39(2), 30–38. Retrieved from: <http://pubs.aged.tamu.edu/jae/>

- Dooley, K. E. (2007). Viewing agricultural education research through a qualitative lens. *Journal of Agricultural Education*, 48(4), 32–42.
- Esters, L. T., & Bowen, B. E. (2005). Factors influencing career choices of urban agricultural education students. *Journal of Agricultural Education*, 46(2), 24–35. Retrieved from: <http://pubs.aged.tamu.edu/jae/>
- Frisbee, R. L., Belcher, G., & Sanders, R. E. (2000). Recruitment techniques that influence students to attend four-year automotive programs. *Journal of Vocational Education Research*, 25(2). Retrieved from: <http://scholar.lib.vt.edu/ejournals/JVER/>
- Gardner, L. (2008). Review: Memoing in qualitative research: Probing data and processes. *Journal of Research in Nursing*, 13(1), 76-77. [Electronic version] doi: 10.1177/1744987107081252.
- Guba, E. G., & Lincoln, Y. S. (1989). *Fourth generation evaluation*. Newbury Park, CA: Sage Publications, Inc.
- Heckman, J. L. (2000). *Invest in the Very Young*. Chicago, IL: Ounce of Prevention Fund. Retrieved from: <http://www.ounceofprevention.org/downloads/publications/Heckman.pdf>
- Jones, W. A., & Larke, A. L. Jr. (2001). Factors influencing career choice of African American and Hispanic graduates of a land-grant college of agriculture. *Journal of Agricultural Education*, 42(1), 39-49. Retrieved from: <http://pubs.aged.tamu.edu/jae/>
- Kantrovich, A. J. (2007). *A national study of the supply and demand for teachers of agricultural education from 2004-2006*. Grand Haven, MI. Michigan State University. Retrieved from: <http://www.aaaeonline.org/>
- Kezar, A. (2001). Investigating organizational fit in a participatory leadership environment. *Journal of Higher Education Policy and Management*, 23(1), 85–101.
- Lindholm, J. A. (2003). Perceived organizational fit: Nurturing the minds, hearts, and personal ambitions of university faculty. *The Review of Higher Education*, 27(1), 125–149.
- Merriam, S. B. (1998). *Qualitative research and case study application in education*. San Francisco: Jossey-Bass Inc.
- Miller, W. W., Kahler, A. A., & Rheault, K. (1989). Profile of the effective vocational agriculture teacher. *Journal of Agricultural Education*, 30(2), 33–40.
- National FFA Organization, (2005). 10,000 quality programs by 2015. *FFA Advisors Making a Difference*, 14(3), 8. Retrieved from: <http://www.ffa.org/ageducators/mad/archives.cfm>
- Osipow, S. H. (1990). Convergence in theories of career choice and development: Review and prospect. *Journal of Vocational Behavior*, 36, 122–131.

- Park, T. D., & Rudd, R. (2005). A description of the characteristics attributed to students' decision to teach agriscience. *Journal of Agricultural Education*, 46(3), 82–94. Retrieved from: <http://pubs.aged.tamu.edu/jae/>
- Patton, M. Q. (2002). *Qualitative research & evaluation methods (3rd ed.)*. Thousand Oaks, CA: Sage Publications Inc.
- Roberts, T. G., Greiman, B. C., Murphey, T. H., Ricketts, J. C., & Harlin, J. F. (2009). Changes in student teachers' intention to teach during student teaching. *Journal of Agricultural Education*, 50(4) 134-145. Retrieved from: <http://jae.expressacademic.org/login.php>
- Roberts, T. G., Dyer, J. E. (2004). Characteristics of effective agriculture teachers. *Journal of Agricultural Education*, 45(4), 82–95. doi: 10.5032/jae.2004.04082
- Robinson, J. S. (2010). A qualitative analysis of alternatively certified agricultural education teachers on their first year of employment in the teaching profession. *Journal of Southern Agricultural Education Research*, 60(2), 25–39. Retrieved at <http://www.jsaer.org/pdf/Vol60/2010-60-003.pdf>
- Sandelowski, M. (2000). Focus on research methods: Whatever happened to qualitative description? *Research in Nursing & Health*, 23, 334–340. doi: 10.1002/1098-240X(200008)
- Stevenson, C. (1987). How does an undergraduate decide about becoming a teacher?. *Teaching Education*, 1(2), 42–45.
- Trochim, W. (2006). *Qualitative validity*. Retrieved from <http://www.socialresearchmethods.net/kb/qualval.php>
- Wright, M. D., & Custer, R. L. (1998). Why they want to teach: Factors influencing students to become technology education teachers. *Journal of Technology Education*, 10(1), 58–70. Retrieved from: <http://scholar.lib.vt.edu/ejournals/JTE/>

An Analysis of North Carolina Public School Superintendents' Awareness of Biotechnology and the Future of Biotechnology Education

*Antoine Alston, Chastity Warren English, Mulumebet Worku, Guochan Yang,
North Carolina A & T*

Abstract

The purpose of this study was to gauge the perception of North Carolina public school superintendents regarding Biotechnology and its future in the North Carolina public school curriculum. It was found that respondents overall were knowledgeable about biotechnology and saw it as beneficial in general health, nutrition, and environmental quality. With regard to the barriers of biotechnology respondents indicated that religious concerns, lack of education, ethical issues, access, labeling, and legislation were barriers. In contrast, respondents were undecided if socioeconomic factors, ecological factors, and perceptions regarding the safety of genetically engineered organisms were barriers. As for the future of biotechnology education respondents indicated that universities and industry would be important to its future, but were undecided if public support existed with respect to its implementation. Also uncertainty surrounded the need for more rigorous teacher preparation programs and the need for special programs with respect to workforce preparation. Recommendations included biotechnology stakeholders forming partnerships with school administrators and key community leaders in order to ensure the future of biotechnology education in North Carolina.

Introduction

The rapid pace of technological innovation coupled with great economic uncertainty has significantly impacted the way business is conducted within the 21st century global society. With this change comes the need for companies, particularly those within the bioscience sectors, to fill entry-level and advanced positions with individuals who possess cutting edge knowledge, dynamic skills, and excellent dispositions to successfully maneuver in a highly competitive and high-stakes industry. Given the aforementioned factors, biotechnology firms many times are in need of more highly skilled workers than are available, particularly in training programs within their local region (United States Department of Labor, 2008).

According to the Battelle Technology Partnership Practice (2009), there are many indicators that show the United States is slipping in generating the skilled educated workforce that is necessary to meet the requirements for a highly technical and trained workforce in the knowledge-based economy of today. Workers are needed in the bioscience industry to translate innovation into product development, conduct research, improve health care techniques, and produce bioscience related products. The availability of a highly skilled and educated workforce is imperative to the United States sustaining a highly competitive and vigorous bioscience industry for the long run. This is especially important from an economic security perspective as other nations are gaining ground in the Science, Technology, Engineering, and Math (STEM) disciplines, while interest among American students in the STEM areas continues to decline.

The Food and Agriculture Organization of the United Nations (2010) defined biotechnology “any technological application that uses biological systems, living organisms, or derivatives thereof, to make or modify products or processes for specific use.” Given that biotechnology is not just comprised of one discipline, but the blending of many disciplines, the

ideal training for employees in biotechnology is traditional biological science, with specific emphasis upon areas such as biochemistry, molecular biology, virology, genetics, and biochemical engineering. Taking into account the aforesaid factors and the ever changing biosciences industry, firms are consistently seeking workers with more formalized training in both life sciences and computers, coupled with a strong general educational background (United States Department of Labor, 2008).

With regard to the bioscience industry, over 1.42 million individuals were employed in 2008. In the area of research, testing, and medical labs, 11,670 jobs (2.1 %) were added from 2007 to 2008, medical devices and equipment added 10,140 jobs (2.4 %), and agricultural feedstock and chemicals added 5,021 (4.6 %). According to Battelle Memorial Institute (2010), the total employment by sector was as follows: Agricultural Feedstock & Chemicals (114,793), Drugs & Pharmaceuticals (311,882), Medical Devices & Equipment (435,509), and Research, Testing, and Medical Laboratories (558,140).

In order to ensure America's continued economic growth and national security advances in science and engineering, particularly in biotechnology are essential. Over the next decade, the demand in the United States for scientists and engineers is projected to increase at four times the rate of all other occupational sectors. Despite this factor, high school students of today are not performing at sufficient levels in math and science, with even fewer pursuing degrees in various technical fields (The International Society for Optical Engineering, 2008a). When analyzing this concern with respect to demographics only 4.4 % of science and engineering jobs are held by African Americans and only 3.4 % by Hispanics. With regard to gender, significant gaps exist in this area as well according to numerous studies (The International Society for Optical Engineering, 2008b).

The International Society for Optical Engineering (2008b) stated interest in STEM education has greatly declined with the majority of students in the United States not adequately prepared to succeed in college-level coursework. Moreover, students who were the most likely to pursue studies in STEM career pathways are those who develop a disposition for these respective areas early in career planning and enroll in challenging courses that provided them with the preparation for college-level science and math coursework. Public funding and support are not only critical to alleviating the aforementioned issue, but also assist in economic growth. According to many economists over the past 50 years, taxpayer investment in science and mathematics in essence has indirectly produced more than half of the nation's economic growth, an economic investment that starts within the public educational systems (The International Society for Optical Engineering, 2008b).

According to the North Carolina Department of Public Education (2006), North Carolina has the third largest concentration of biotechnology companies in the United States. The biotechnology industry in North Carolina is comprised of 110 contract research and testing companies, 60 agricultural biotechnology companies, 13 publically traded companies that have a market capitalization of \$11.8 billion, and employ over 57,000 individuals. Of these companies at least 75 are based upon North Carolina's universities technologies. In North Carolina about 145 bioscience patents are granted each year to companies and universities, which accounts for about 12% of all patents issued in the state. Biotechnology has an annual impact upon North Carolina's agricultural industry. In 2006, the food and fiber production was increased by 86.6 million pounds and pesticide use was reduced by 3.5 million pounds (North Carolina Biotechnology Center, 2010b).

The future viability of North Carolina's biotechnology industry greatly depends upon the development of essential knowledge, skills, and dispositions in regard to biotechnology in the public school students of today, who are the industry's future workers and consumers (United States Department of Labor, 2008). According to the North Carolina Biotechnology Center (2010a) in the state of North Carolina biotechnology is not offered as a core science option in the standard course of study, but instead is embedded across various courses within the Career and Technical Education areas of Agricultural Education (Biotechnology and Agriscience Research I&II, Horticulture I&II), Family and Consumer Science (Foods II – Food Technology), Technology Education (Scientific and Technical Visualization I&II, Project Lead The Way – *Biotechnical Engineering specialty course*), and Health Occupations (Biomedical Technology, Medical Sciences I&II).

The State of North Carolina has made a commitment to biotechnology with its BioNetwork Initiative program. The program is located within agricultural education programs at community colleges and universities that are industry focused, providing hands-on training for an industry that greatly values the technical and scientific training of its employees. The BioNetwork established its center for BioAgriculture at Robeson Community College. The commitment also includes the North Carolina Department of Public Instruction and local education agencies (LEAs) throughout the state of North Carolina. The commitment to educational initiatives such as biotechnology by local education agencies is heavily influenced by superintendents, who are vital to the successful incorporation of any subject matter into the curriculum. Without their support, initiatives such as biotechnology are not feasible (North Carolina Biotechnology Center, 2009). Given the importance of the biotechnology industry to North Carolina's economic vitality, it is imperative that North Carolina's public schools chief administrators support the incorporation of biotechnology throughout the standard course of study on a broader scale.

Theoretical Framework

The theoretical framework for this study was built upon the theory of social judgment and the concept of cognitive dissonance. The theory of social judgment focuses on how people's prior attitudes distort their perceptions of the positions advocated in persuasive messages and how such perceptions mediate persuasion. Specifically, the theory assumes that a person's own attitudes serve as a judgmental standard and anchor that influences where along a continuum a persuader's advocated position is perceived to lie (Sherif & Hovland, 1961). The social judgment theory is an attempt to apply the principles of judgment to the study of attitude change (Sheirf & Hovland, 1961). According to Sherif, Sherif, and Nebergall (1965), an individual's initial attitude serves as an anchor for the judgment of related attitude communications. Opinions are evaluated against this point of reference and are placed on an attitudinal continuum. Opinions that most characterized the individual's own opinion are in the latitude of acceptance. Those opinions found most objectionable are placed in the latitude of rejection. The latitude of non-commitment consists of those opinions that are neither accepted nor rejected.

Communication that falls within the latitude of acceptance is assimilated and if judged to be fair and unbiased will result in a change in attitude within the limits of the latitude of acceptance. The greater the difference between the initial opinion and the communicated opinion, the greater the attitude change. Though some change is possible when opinions fall

within the latitude of rejection, the greater the discrepancy the less the change in attitude (Himmelfarb & Eagly, 1974). In summary, social judgment theory is important because it demonstrates the importance of people's prior attitudes. Most other learning theories only deal marginally with previous attitudes. Newer theories incorporate social judgment principles as covariates and control variables in experimental designs (Wood, 1982).

In addition to the theory of social judgment, the concept of cognitive dissonance served as guiding framework for this study. According to Swanson (1972) a person will gradually begin to associate positive communications to an area or a subject, in this case biotechnology, as their knowledge increases, which in turn affects their attitude, and finally behavior towards biotechnology. The concept simply stated is that knowledge and experiences are precursors to attitudinal changes that must occur before behavior can change (See *Figure 1.*)

Education → Knowledge → Attitudes → Behavior

Figure 1. Assumed relationships among education, knowledge, attitude, and behavior – Concept of Cognitive Dissonance (Swanson, 1972).

Purpose and Objectives

The purpose of this study was to gauge the perception of North Carolina public school superintendents regarding Biotechnology and its future in the North Carolina public school curriculum. In order to accomplish the aforementioned purpose, the following research questions were developed.

1. What was the awareness level held by North Carolina Public Superintendents regarding biotechnology?
2. What was the confidence level held by North Carolina Public Superintendents regarding their awareness of selected biotechnology factors?
3. What were the barriers to biotechnology implementation as perceived by North Carolina Public School Superintendents?
4. What was the future of biotechnology education in North Carolina Public Schools as perceived by North Carolina Public School Superintendents?
5. What were the demographic characteristics of North Carolina Public School Superintendents who Local Education Agency possessed at least one agricultural education program?

Methodology

The population for this descriptive study consisted of North Carolina Public School Superintendents whose respective local education agency (LEA) possessed at least one secondary agricultural education program. Of the 115 local education agencies in North Carolina, 93 possessed at least one agricultural education program. Given this factor the final study population was determined to be 93. In order to accomplish the aforementioned objectives of this study a survey instrument was adopted from a previous study conducted by Totten (2007).

The survey instrument consisted of five sections. The sections were entitled Section I: General Awareness of Biotechnology, Section II: Benefits of Biotechnology, Section III: Barriers to Biotechnology, Section IV: Future of Biotechnology Education in North Carolina, and Section V: Demographic Characteristics. The validity of the instrument was established by means of content validity. Brown (1983) defined content validity as “the degree to which items on a test representatively sample the underlying content domain (p. 487).” Brown recommended using expert judges as one means of establishing content validity. A panel of experts at the researchers’ respective university reviewed the survey instrument for content validity, no adjustments were made as a result of the review. A pilot test of the study was conducted with superintendents outside of North Carolina. In relation to non response error a comparison was made between early to late respondents of the pilot study, no differences were noted (Miller & Smith, 1983). To establish internal consistency reliability, the instrument was analyzed using the software package SPSS according to conventions established by Nunnally (1967) and Davis (1971). The Chronbach's Alpha Coefficients for the study were as follows: Section I: .9273, Section II: .9782, Section III: .9096, and Section IV: .9500. All sections of the research survey were deemed to be reliable.

Elements of Dillman’s Tailored Design Method (2009) were utilized to achieve an optimal return rate. A three-round web based questionnaire approach was utilized for this study. The first round consisted of all superintendents within the selected population receiving a letter from the researchers outlining the purpose of the research, which included a login and password for each prospective respondent. Superintendents were given one week to return the initial survey, 24 surveys were returned after the first week. The next round consisted of all non-respondents receiving a follow-up email stressing to them the importance of returning the survey for data analysis purposes and to strengthen the study, this resulting in ten more surveys. A final reminder email was sent at the end of the beginning of the third week, this resulted in nine more surveys being returned. After all collection rounds were completed the final total was 43 returned for a response rate of 46 %.

Findings

Research Question One Findings

In relation to superintendents’ knowledge of biotechnology it was found that participants overall were aware of the selected biotechnology concepts addressed in the survey, with the exception of four statements. For the purposes of this research a statement was operationalized to possess a level of awareness if more than 50% of respondents answered the statement correctly. As shown in Table 1, exceptions were found with regard to perceptions of the development of human organs within livestock species, governmental required labeling of genetically modified products, biotechnology regulation based upon use versus method of production, and lastly traditional livestock and crop production utilizing cross-breeding and cross-fertilization.

As far as confidence with regard to their responses, participants in general were sure of their answers, with exceptions being found on seven statements. For the purposes of this research a statement was operationalized to be answered affirmatively if more than 50% of respondents indicated they were sure about their response to the biotechnology statement. Exceptions were noted in relation to perceptions regarding the percentage of meat products that are from genetically-modified livestock, biotechnology being utilized to create new living

organisms, cloning, the strength of genetically modified animals, labeling of genetically modified products, biotechnology regulation based upon utilization, and traditional livestock and crop production utilizing cross-breeding and cross-fertilization.

Table 1
General Awareness of Biotechnology

Statements	<i>f</i> True	<i>f</i> False	<i>f</i> Sure	<i>f</i> Unsure
Biotechnology is defined as the use of molecules from living organisms to create new products.	33*	10	26	18
Biotechnology makes it possible for scientists to create new plants and animals by taking parts of the genes of one plant or animal and inserting them into another.	32*	11	20	24
Human, animal, plant and microbial genes can be altered with current biotechnology techniques	38*	5	28	15
Genes control visible and invisible characteristics of living organisms.	41*	2	34	10
A gene is a specific sequence of DNA that serves as a unit of inheritance.	41*	2	34	10
Most consumers in the United States have eaten food products created through biotechnology.	41*	2	34	10
A large percentage of meat products bought by consumers are obtained from genetically-modified livestock.	41	2*	33	11
Forensic biotechnology allows the analysis of DNA to help solve crimes.	23*	21	22	21
Pharmaceutical companies currently market drugs developed using biotechnology.	41*	2	34	10
Plant biotechnology can regenerate whole plants from individual plant cells.	40*	3	32	12
Cloning of a plant or animal creates an identical copy.	37*	6	19	24
Biotechnology has allowed the development of livestock that produce human organs that will not be rejected by transplant recipients.	33	9*	26	16
Genetically-modified animals are larger and stronger than normal.	15	26*	15	27
The government requires that all genetically-modified products have clear labeling.	14*	29	13	28
The Environmental Protection Agency regulates all biotechnology products.	22*	21	23	20
Biotechnology products are regulated based on their use rather than on the method by which they were produced.	15*	28	16	26

Genetically-modified bacteria, fungi, and plants can clean up toxic waste sites in a process called bioremediation.	26*	13	10	32
Pesticide-producing genes can be directly incorporated into crop plants so the need for additional pesticide application is reduced or eliminated.	36*	5	14	29
Traditional livestock and crop production does not use cross-breeding or cross-fertilization.	34	9*	23	21

*Correct Response

Research Question Two Findings

Respondents were asked to give their opinion on the benefits of biotechnology. Table 2 presents the means and standard deviations (SD) for the benefits of biotechnology. For the purpose of data analysis, readers should utilize the following specifications when interpreting the scale for Tables 2, 3, and 4 1-1.49=Strongly Disagree, 1.50-2.49=Disagree, 2.50-3.49=Uncertain, 3.50-4.49=Agree, and 4.50-5=Strongly Agree. In relation to the perceived benefits of biotechnology respondents agreed with all 20 statements. The highest levels of agreement was noted in relation to the perception of the development of unique products from aquatic sources, increased crop yields on less land, more accurate criminal investigations, economic savings for consumers, and improved methods to fight bioterrorism. The lowest levels of agreement were found in relation to more effective waste treatment techniques, valuable technology for the United States, and reduced environmental impact from industrial activities.

Table 2
Benefits of Biotechnology

Benefits	M	SD
Development of unique products from aquatic sources.	4.39	.655
Increased crop yields that can be realized on less land.	4.35	.613
More accurate criminal investigations.	4.35	.650
Economic savings for consumers.	4.33	.644
Improved methods to fight bioterrorism.	4.30	.734
More effective pharmaceuticals.	4.26	.658
Protection of groundwater supplies.	4.19	.588
Reduced need for chemical pesticides.	4.14	.675
Alleviation of malnutrition.	4.14	.833
Better animal health management.	4.09	.750
Improved fabrics.	4.02	.762
Improved human medical care.	3.95	.844
More nutritious and better tasting foods.	3.95	.899
New fuel sources.	3.91	.684
Improved soil conservation.	3.88	.905
Increased quality of life for people in developing countries.	3.88	.731

Greater economic profitability for farmers.	3.86	.824
Reduced environmental impact of industrial activities.	3.84	.814
Valuable technology for the citizens of the United States.	3.84	.843
More effective waste treatment techniques.	3.65	1.11

Research Question Three Findings

Respondents were asked to give their opinion on the subject of barriers and obstacles in relation to biotechnology. Table 3 presents the means, standard deviations (SD), and rank for the barriers and obstacles of biotechnology. The highest levels of agreements were found in relation to religion being a barrier to biotechnology, lack of education, and ethical issues regarding its use on a global scale. In contrast respondents were undecided regarding the socioeconomic perspective of biotechnology, biotechnology having a negative ecological impact, and the negative perception regarding the safety of genetically engineered foods.

Table 3
Barriers to Biotechnology

Barriers and Obstacles	M	SD
Religious concerns are a major barrier to biotechnology acceptance.	4.48	.590
Lack of education leads to resistance toward biotechnology products.	3.98	.628
Ethical issues regarding biotechnology are a major barrier to its extensive use on a global scale.	3.95	.776
Equal access to the benefits of biotechnology will not be realized by all sectors of society.	3.82	.947
Issues concerning the labeling of genetically modified foods can have a major impact upon the agricultural industry.	3.73	.924
Legislation is a major barrier to broad biotechnology implementation throughout society.	3.59	.787
The economic cost of biotechnology research is a barrier to its widespread practical daily implementation.	3.50	.792
From a socio-economic perspective biotechnology can affect the relationship between and relative power of different groups in society.	3.45	1.044
Biotechnology can have negative ecological impacts which reduce its acceptance.	3.34	.888
The negative perception regarding the safety of genetically engineered food is a major barrier to biotechnology.	3.18	.870

Research Question Four Findings

Respondents were asked to give their opinion on the subject of the perceived future of biotechnology education. Table 4 presents the means, standard deviations (SD), and rank for the future of biotechnology education. The highest level of agreements were found in relation to offering biotechnology as a general science core option, utilizing industry and university biotechnology specialist to teach special topics within the public schools, and infusing industry

grants into public schools in order to encourage biotechnology incorporation. In contrast respondents were undecided if special programs concerning biotechnology should be implemented for students with an interest in the industry. Additionally, indecision was noted with regard to whether teacher education programs should revise their respective baccalaureate degree programs with respect to biotechnology and whether there would be great public support for biotechnology education at the secondary level.

Table 4
Future of Biotechnology Education

Statements	M	SD
Biotechnology should be offered as a general science option for the core curriculum.	4.34	.645
Industry and university biotechnology specialists should be utilized to teach special biotechnology topics in the public school systems.	4.26	.621
Industry grants should be provided to public school systems to infuse biotechnology education into their respective curricula.	4.25	.811
North Carolina students will be interested in enrolling in biotechnology courses and programs.	4.05	.806
Industry leaders should aid in biotechnology curriculum development in North Carolina's public schools.	4.05	1.05
Special programs concerning biotechnology should be implemented for "college/university" prep students.	4.02	.731
Internships should be provided in biotechnology-related organizations as an option for "College Tech Prep" work-based experience requirements.	4.00	1.01
North Carolina's universities should have a major impact on the infusion of biotechnology at the secondary level of education.	4.00	.610
Universities should offer advanced placement courses concerning biotechnology at the secondary level.	3.91	.830
Public school administration overall should be supportive of biotechnology education.	3.84	1.03
Biotechnology education can help alleviate negative public perception regarding the industry.	3.82	.843
The supply of qualified teachers to teach biotechnology will be very low.	3.75	.967
Programs should be developed to link secondary level education in biotechnology with current community college biotechnology programs.	3.68	1.07
Industry and university biotechnology specialists should be utilized to teach special biotechnology topics in the public school systems.	3.66	.834
The North Carolina General Assembly should provide funding to develop and infuse biotechnology curriculum into the public school system.	3.59	.923
Special programs concerning biotechnology should be implemented for students hoping to enter the bio-manufacturing workforce after high school graduation.	3.41	1.14

The infusion of biotechnology into North Carolina's standard course of study will require teacher education programs to revise and plan more rigorous baccalaureate degree programs.	3.30	.823
There will be great public support for biotechnology education at the secondary level in North Carolina.	3.20	.878

Research Question Five Findings

Table 5 displays the demographic characteristics of the North Carolina public school superintendents who participated in this respective study. The average age of respondents was 53 years of age, with the majority being Caucasian males who held a doctorate degree. In relation to years of public education experience, the average experience level was 22 years, with seven being the average years of experience as a superintendent.

Table 5

Demographic Characteristics of North Carolina Public School Superintendents

Demographics	n	M or %	SD
Age		53	5.34
Gender			
Male	35	80	
Female	9	21	
Race			
Caucasian	37	84	
Black	7	16	
Years of Public Education Experience		20	7.04
Administrative Experience as Superintendent		7	5.30
Education			
Masters	8	18	
Specialist	10	23	
Doctorate	26	59	

Table 6 provides the demographic data for the local education agencies (LEAs) for which the respondents administrate. With regard to the average number of schools within the LEAs, 20 were found to be the mean level, with an average enrollment level of 12,945 students. The majority of the school districts were labeled as rural with 29% indicated a combination status.

Table 6
Local Education Agency Demographics (LEA)

Demographics	n	M or %
Total number of schools in L.E.A.		20
Total number of students in L.E.A.		12,945
Type of L.E.A.		
Urban	2	5
Rural	29	66
Combination	13	30

Conclusions

In relation to the knowledge level possessed by North Carolina's public school superintendents in relation to biotechnology, overall respondents were knowledgeable regarding the selected concepts and possessed a level of confidence in their respective answers. According to Swan (1972), the knowledge that a person possesses regarding a particular topic in turn influences their attitude and behavior regarding that subject matter. When considering perceptions about the benefits of biotechnology, respondents in general agreed with all statements provided. As stated by Sherif and Hovland (1961), an individual's initial attitude towards a subject serves as an anchor with regard to any future communication regarding the subject. Given that the superintendents within this study were positive about the benefits of biotechnology, the effort to infuse biotechnology broadly throughout the public schools could perhaps be easier, if the support of the superintendents is solicited for specific initiatives.

With regard to the barriers of biotechnology, respondents indicated that religious concerns, lack of education, ethical issues, access, labeling, and legislation were barriers. In contrast respondents were undecided if socioeconomic factors, ecological factors, and perceptions regarding the safety of genetically engineered were barriers. According to Eagly and Chaiken (1993), positions falling within the latitude of rejection will be contrasted away from a person's initial attitude regarding a particular subject, thus causing them to develop a negative perception regarding the specific variable.

With respect to views regarding the future of biotechnology education in North Carolina respondents agreed that industry and university experts should be involved with the development of biotechnology in the public schools, and that public school administration and the General Assembly should support biotechnology education. It was also agreed upon that students would be interested in biotechnology programs if created and that special programs should be implemented for college prep and tech prep students in relation to biotechnology. In contrast respondents were undecided if special programs regarding biotechnology should be developed for individuals desiring to enter the bio-manufacturing industry after high school. Additionally, superintendents were undecided if the future of biotechnology education would require the development of more rigorous teacher education programs or if there would be adequate public support for biotechnology education. It appears that superintendents are supportive of biotechnology education, and recognize the need for multiple stakeholder involvement in its development, but appear to be somewhat undecided about its future in some key areas. This could be due to the variety of information that they are given about the subject that fall within

their latitude of rejection, thus contrasting with their initial anchor position (Eagly & Chaiken, 1993).

Recommendations

When considering the recognized economic importance of biotechnology to North Carolina and the push for better preparation of students in relation to the STEM disciplines, it is recommended that North Carolina's public school superintendents collaborate with various stakeholder groups to ensure infusion of biotechnology throughout the North Carolina Standard Course of Study. This would aid in implementing the recent recommendations that States should incorporate biotechnology as they revise their science standards and should involve research scientists with expertise in the biosciences in their development (Battelle, 2009). As a result of President Obama's "Education to Innovate" campaign, initiatives such as the Biotechnology Institute's "Scientist in the Classroom" which is designed to train and deploy scientists from 40 companies with secondary teachers and students in high-impact laboratory settings will better prepare students in the STEM disciplines (Biotechnology Institute, 2010). A collaborative effort such as this is the future of biotechnology education.

Implications

According to the Labor Day Report (2005) America's ability to compete in the 21st century will not be determined by just performance, but its workforce ability to invent and innovate. Regrettably, signs show that America's workforce is not prepared to meet innovation's challenge, and its position as the global economic leader is threatened. According to Paul A. Hanle (2010):

The United States is the global leader in biotechnology innovation. Our industry creates high-wage jobs while developing breakthrough technologies that help heal the sick, feed the hungry, and restore the environment ... The ability of the United States to continue to lead in the global biotechnology marketplace depends on developing new talent.

Superintendents and school administrators will be at the fore front of collaborative opportunities with the biotechnology industry as the biotechnology industry is investing in bioscience education by contributing to class room instruction through innovative programs to address needs in STEM education.

References

- Battelle Memorial Institute. (2010). *Executive summary battelle/bio state bioscience initiatives 2010*.
- Battelle Technology Partnership Practice. (2009). Taking the pulse of bioscience education in America: A State-by-State Analysis
- Biotechnology Institute. (2010). Biotechnology industry announces new initiative to improve U.S. science education industry Retrieved from

http://www.biotechinstitute.org/news/news_detail.php?news_id=69

- Davis, J.R. (1971). *Elementary survey analysis*. Englewood Cliffs, NJ: Prentice Hall.
- Dillman, D. A., Smyth, J. D., & Christian, L. M. (2009). *Internet, mail, and mixed-mode surveys: The tailored design method*. Hoboken, New Jersey: John Wiley & Sons, Inc.
- Eagly, A. & Chaiken, S. (1993). *The Psychology of Attitudes*, Fort Worth, TX: Harcourt Brace Jovanovich
- Food and Agriculture Organization of the United Nations. (2010). FAO statement on biotechnology. Retrieved from <http://www.fao.org/biotech/stat.asp>
- Himmelfarb, S. & Eagly, A. (1974). *Readings in Attitude change*. Wiley: New York.
- The International Society for Optical Engineering. (2008a). *North Carolina's k-12 stem ed report card. Federal funding for k-12 stem education: an urgent national priority*. Washington: SPIE
- The International Society for Optical Engineering. (2008b). *STEM education coalition 2008, North Carolina's k-12 stem ed report card*. Washington: SPIE
- Labor Day Report. (2005). *The looming workforce crisis: Preparing America's workforce for 21st century competition*. National Association of Manufacturers.
- Miller, L. E., & Smith, K. L. (1983). Handling non-response issues. *Journal of Extension*, 21(5), 45-50.
- North Carolina Biotechnology Center. (2010a). High school career development schedule. Retrieved from http://www.ncbiotech.org/resource_center/guide_to_biotechnology/what_jobs_exist
- North Carolina Biotechnology Center. (2010b). North Carolina biotechnology industry facts. Retrieved from http://www.ncbiotech.org/news_and_events/media_center/facts.html
- North Carolina Biotechnology Center. (2009). *Growing North Carolina's agricultural biotechnology landscape: success, challenges, and strategies*. Research Triangle Park, North Carolina.
- North Carolina Department of Public Education. (2006). *Career pathways: Focus on biotechnology*. Raleigh, North Carolina
- Nunnally, J.C. (1967). *Psychometric theory*. New York, NY: McGraw Hill Book Co. Inc.
- Sherif, M., & Hovland, C. I. (1961). *Social judgment: Assimilation and contrast effects in communication and attitude change*. Westport, CT: Greenwood Press.

Sherif, C.W., Sherif, M.S., & Nebergall, R.E. (1965). *Attitude and attitude change*. Philadelphia: W.B. Saunders Company.

Swanson, J. C. (1972). Second thoughts on knowledge and attitude effects upon behavior. *The Journal of School Health*, XLII (6), 363-365.

Totten, T. (2007). *An Analysis of North Carolina Secondary School Principals Awareness of Biotechnology and the future of Biotechnology Education* (Unpublished master's thesis). NC A&T State University, Greensboro, N.C.

United States Department of Labor. (2008). High growth industry profile biotechnology. Retrieved from http://www.doleta.gov/BRG/Indprof/Biotech_profile.cfm

How Teacher Self-Efficacy and Job Satisfaction Changed During the Entry-Year of Employment of Agriculture Teachers: A Comparison of Certification Types

J. Shane Robinson

Assistant Professor, Oklahoma State University

M. Craig Edwards

Professor, Oklahoma State University

Abstract

The purpose of this descriptive-correlational study was to assess the level of teacher self-efficacy and job satisfaction of first-year secondary agricultural education teachers in Oklahoma at the beginning and end of their entry-year in the profession. This study found that these first-year teachers increased their level of teacher self-efficacy throughout the year. Alternatively certified (AC) teachers indicated the largest amount of perceived growth across three teacher self-efficacy constructs. However, when comparing certification types on job satisfaction, AC teachers decreased in their level of job satisfaction from the beginning to the end of the school year. When considering the assessment scores of university supervisors, it was found that traditionally certified teachers out performed their AC counterparts by roughly a one-half point margin on each construct. Further, traditionally certified teachers performed significantly better on the student achievement indicators standard than did AC teachers. It was found that the difference in effect size between traditionally and AC teachers was between “medium” and “large” on all constructs. Finally, this study revealed that traditionally certified teachers had higher retention rates as compared to their AC teacher counterparts.

Introduction

The National Research Agenda for Agricultural Education and Communications identified a priority area to “prepare and provide an abundance of fully qualified and highly motivated agriscience educators at all levels” (Osborne, n.d., p. 3). This priority area was targeted, in part, because of the teacher shortage in agriculture (Kantrovich, 2007). In fact, a looming teacher shortage has been an issue across all domains and disciplines of teaching at the primary and secondary school levels (Feistritzer & Haar, 2008; Good et al., 2006; Hess, 2000) and is prevalent in agricultural education as well.

Research has noted that teacher preparation institutions have struggled to meet the increasing demand of the teacher shortage problem (Lynch, 1996; Steadman & Simmons, 2007), due, in part, to high teacher turnover rates. Ruhland (2001) stated that, “it is far more cost effective to retain teachers than to hire [them]” (p. 3). As a result of the teacher shortage crisis, alternatively certified (AC) teachers have been employed to “fill the gap” (Feistritzer & Haar, 2008; Shoho & Martin, 1999). However, the effect and credibility of AC teachers has been questioned due to the fact they have not received formal pedagogical preparation in college, nor have they experienced the student teaching internship (Young & Edwards, 2006).

“Alternative certification routes are non-traditional routes designed for individuals who have not completed a baccalaureate degree in education” (Ruhland & Bremer, 2002). Because of this lack of experience, AC teachers arrive at teaching differently than traditionally certified teachers. As such, they “. . . do not receive the same degree of pedagogical instruction and experience as

traditionally certified teachers” (Blackburn, 2007, p. 19). Robinson (2010) found that first-year AC teachers in Oklahoma became teachers because they recognized a shortage existed in that state and believed they could be part of the solution. Those teachers believed they were providing a “professional service” by opting to teach.

Because of their lack of pedagogical preparation, it is important to understand how AC teachers compare to traditionally certified teachers regarding their level of self-efficacy to teach secondary agricultural education. Roberts and Dyer (2004) compared traditionally certified and AC agriculture teachers in Florida to determine their perceived inservice professional development needs. They found that AC teachers expressed the fewest needs in the area of instruction and curriculum. Comparatively, traditionally certified teachers expressed less need for professional development in the areas of technical content, FFA advisement, and supervising students’ projects (i.e., SAEs).

Rocca and Washburn (2005) conducted a study to determine if differences existed between traditionally and AC agriculture teachers in Florida on their perceived levels of self-efficacy. They found that AC teachers were roughly ten years older than their traditionally certified counterparts. Further, they found that AC teachers had similar levels of self-efficacy when compared to traditionally certified teachers. It was implied that because traditionally certified teachers had experienced more pedagogical preparation, they were more critical of their teaching abilities than AC teachers.

Duncan and Ricketts (2008) conducted a study in which they compared traditionally and AC agriculture teachers in Georgia on program efficacy. They concluded that traditionally certified teachers had the highest levels of efficacy related to program management. In contrast, AC agriculture teachers had the highest levels of efficacy in common pedagogical practices. The lowest levels of program efficacy for both groups were in content knowledge related to technical agriculture subjects. The authors recommended professional development for both groups of teachers at statewide in-service workshops to improve their overall level of program efficacy.

Bandura (1993) stated that self-efficacy is the belief an individual has for accomplishing a given task or job. Therefore, it could be implied that teachers’ sense of self-efficacy may be related to their level of job satisfaction. Job satisfaction has been tied to teacher retention. Chapman (1984), for example, stated job satisfaction was “significantly related to persons’ decisions to leave (or never enter) teaching” (p. 654). Ingersoll (2001) found that teachers leave the profession due to retirement, school staffing actions, personal reasons, to pursue another job, and dissatisfaction overall. Blackburn and Robinson (2008) recommended that future studies be conducted to determine how teacher self-efficacy and job satisfaction are related over time.

The conceptual framework of this study relied on Bandura’s (1977) self-efficacy theory. Bandura (1993) posited that an individual’s perception of self-efficacy dictated how they perceive themselves and react in certain situations. Bruinsma and Jansen (2010) stated that, “Teacher self-efficacy is one of the self-efficacy belief types studied in education” (p. 188). Tschannen-Moran, Woolfolk-Hoy, and Hoy (1998) asserted that teacher self-efficacy is “the teacher’s belief in his or her own capability to organize and execute courses of action required to successfully accomplish a specific teaching task in a particular context” (p. 223). Bruinsma and Jansen also opined that, “people with high self-efficacy approach difficult tasks as challenging instead of as

threats” (p. 188). As such, higher levels of teacher self-efficacy should be related to higher levels of teacher retention (Bruinsma & Jansen; Coldarci, 1992; Rots, Aelterman, Vlerick, & Vermeulen, 2007; Tschannen-Moran & Woolfolk Hoy, 2001) and teacher job satisfaction (Blackburn & Robinson, 2008).

Coladarci found that, “. . . efficacy significantly predicted commitment to teaching” (p. 332) and sex, school class size, as well as administrative support were also predictors of teacher commitment. Bruinsma and Jansen (2010) suggested that the quality of an individual’s teacher preparation program is related to teacher commitment (i.e., retention). However, the literature is lacking regarding how a teacher entry program (i.e., alternative certification) relates to teacher efficacy and retention. To that end, Roberts and Dyer (2004) opined, “Traditional thinking is that professionally prepared agriculture teachers (teachers with a degree in agricultural education) would be better prepared than their counterparts who entered teaching through alternative certification” (p. 68). Regardless, Darling-Hammond and Sykes (2003) stated that more emphasis should be placed on retaining current teachers than on developing new ones.

Woolfolk Hoy and Spero (2005) stated that people tend to overestimate their abilities often and assume they are capable of doing more than they actually can. However, Hoy and Miskel (2005) stated that teachers who are efficacious will persist with the greatest amount of resiliency when faced with challenges. As such, Woolfolk Hoy and Spero (2005) concluded that, “Efficacy is a future-oriented judgment that has to do with perceptions of competence rather than actual level of competence” (p. 344). To that end, a measure of “actual” competence assessing classroom teaching was warranted in addition to teachers’ “perceptions” of their levels of competence to understand differences in teacher self-efficacy better.

Purpose of the Study

The purpose of this descriptive-correlational study was to assess the level of teacher self-efficacy and job satisfaction of first-year secondary agricultural education teachers in Oklahoma at the beginning and end of their entry-year in the profession. Further, this study sought to compare traditionally and alternatively certified teachers on the assessment scores of their university supervisors, as well as teachers’ retention as agricultural educators. The following research objectives guided the study:

1. Describe selected personal and professional characteristics (i.e., age, sex, highest degree earned, type of certification received) of first-year teachers by certification type.
2. Describe the level of teacher self-efficacy (e.g., student engagement, instructional practices, classroom management) of first-year teachers at the beginning and end of their entry-year of employment by certification type.
3. Describe the level of job satisfaction of first-year teachers at the beginning and end of their entry-year of employment by certification type.
4. Compare university supervisors’ assessments of first-year teachers’ classroom teaching performance by certification type.

5. Compare teacher self-efficacy and employment status (i.e., retention) by certification type.

Because a portion of this study sought to determine differences between traditionally and alternatively certified teachers regarding their performance and retention in the profession, an independent *t*-test was calculated for objective four and a Chi-square analysis was conducted regarding objective five. As such, the null hypothesis for objective four stated that, in the population studied, no statistically significant ($p < .05$) difference existed between traditionally and alternatively certified teachers' performance assessments as perceived by their university supervisors ($H_0: \mu_1$ teacher management indicators = μ_2 teacher instructional indicators = μ_3 teacher products = μ_4 student achievement). To address objective five, the null hypothesis stated that, in the population studied, no statistically significant ($p < .05$) difference existed between traditionally and alternatively certified teachers regarding their retention in the profession ($H_0: \mu_1$ traditionally certified = μ_2 alternatively certified).

Methods

Specifically, this study focused on all entry-year agricultural education teachers ($N = 46$) in Oklahoma who entered the resident teacher (RT) program during the 2007-2008 academic year. The lead researcher has been involved as a university supervisor and professional development presenter for previous first-year teacher cohorts in the RT program for the past four years. Based on that experience, this group was deemed similar in terms of the variables measured in this study (i.e., age, sex, highest degree awarded, and type of certification received). So, this study was deemed a "time and place" sample (Oliver & Hinkle, 1982), thus allowing for the use of inferential statistics.

The RT program in Oklahoma is a mandatory induction year program for all entry-year teachers. Three individuals – principal, mentor teacher, and university supervisor – comprise the RT committee to assist and assess each first-year teacher. The committee provides observations, critiques, support, mentorship, guidance, and suggestions for improvement during the entirety of the year-long RT program. At the conclusion of the academic year, a committee meeting is scheduled to inform the teacher of his/her status. The committee either "passes" the teacher to allow the receipt of a full teaching licensure or opts for the teacher to "repeat" the RT program for another year. As such, university supervisors provide assessments using the Resident Teacher Observation Instrument (RTOI) during their observations of first-year teachers.

The RTOI encompasses the 15 competencies by which all students who desire to teacher certify in Oklahoma must demonstrate competence prior to certification (Oklahoma Commission for Teacher Preparation, n.d.), regardless of educational field. Specifically, the 15 competencies include effective teaching criteria. Ten competencies were derived from the Council for Chief State School Officers Interstate New Teacher Assessment and Support Consortium, three competencies were developed by Oklahoma educators, and two competencies were included as a result of Oklahoma state law.

In an attempt to create consistency among how each individual rater scored teachers on the RTOI (i.e., inter-rater reliability), the three university supervisors who served on RT committees participated in a training session at Oklahoma State University. Specifically, raters met and discussed their perceptions and understanding of the 15 competencies represented on the RTOI.

After a common understanding existed by each member, the instrument was used to critique a video-taped presentation of a former student teacher at Oklahoma State University in an effort to establish consistency among the three raters. After observing and scoring the video, additional discussion ensued to reiterate each member's understanding of the 15 competencies. Due to time constraints of the raters, only one video-tape was observed and scored. As such, a specific reliability estimate was not calculated. Through ocular review of the three ratings, it was noticed that the raters had perfect agreement on four of the items. Two of the three raters reached consensus of agreement on seven items. Only one item, "The teacher relates subject topics to existing student experiences" did not reach a consensus of agreement. Regarding that item, one rater "disagreed," one "agreed," and one "strongly agree" that the teacher had accomplished this objective.

Teachers in the RT program were also assessed on their perceived levels of teacher self-efficacy and job satisfaction. The long form of the Teachers' Sense of Efficacy Scale (TSES), developed by Tschannen-Moran and Woolfolk Hoy (2001), was used to determine teacher self-efficacy for this study. This instrument measured teacher self-efficacy across three constructs: student engagement, instructional practices, and classroom management. It consisted of a nine-point, summated-rating scale ranging from "1" = "Nothing" to "9" = "A Great Deal." Face and content validity were established through a panel of experts consisting of departmental faculty at Oklahoma State University. Tschannen-Moran and Woolfolk Hoy reported reliabilities for each construct based on prior research. The student engagement construct had a reliability coefficient of 0.87. The instructional practices construct had a reliability coefficient of 0.94, and a reliability coefficient of 0.91 was reported for the classroom management construct.

The job satisfaction instrument used in this study was developed by Brayfield-Rothe (1951), as modified by Warner (1973). It consisted of measuring satisfaction and dissatisfaction factors on a five-point, summated-rating scale ranging from "1" = "Strongly Disagree" to "5" = "Strongly Agree." Again, face and content validity for the job satisfaction section were established through a panel of experts. Reliability estimates of this instrument were established through previous research with Ohio secondary agriculture teachers. Cano and Miller (1992a; 1992b) reported a Cronbach's alpha coefficient of .89 and .94, respectively, for this instrument.

Specifically, objective one was addressed by assessing frequencies and percentages of participants' ages, sex, education levels, and years of teaching experience. Objectives two and three employed means and standard deviations to describe teacher self-efficacy and job satisfaction. The analysis of objectives four and five used inferential statistics to compare the performance and employment intentions of the two certification types (i.e., traditional and alternative) assessed in the study. Because this study was deemed a "time and place" sample (Oliver & Hinkle, 1982), inferential statistics were appropriate to use. Yet, because of the relatively small numbers of teachers who comprised the comparison groups (i.e., $n = 34$ traditionally certified teachers; $n = 12$ AC teachers), the reader is cautioned against generalizing the results of the study's sample. For objective four, a *t*-test was used to determine if statistically significant differences existed between university supervisors' assessments of entry-year teachers' classroom teaching performance. And, Chi-square analysis was conducted per objective five to determine the relationship between teacher self-efficacy and teaching status (i.e., retention).

It should be noted that not all entry-year teachers were employed during the first data collection period in August of the school year studied. And, not all entry-year teachers attended the end-of-the-year meeting in May either (i.e., the last data collection period). Finally, the researchers did not receive an RTOI assessment from all university supervisors. So, the numbers of responses and/or participants in the study from the initial data collection period to the final data collection period are inconsistent, i.e., some data are missing. This inconsistency is recognized as a limitation of the study.

Findings

The first objective sought to describe the personal characteristics of first-year secondary agricultural education teachers by certification type. In all, 34 first-year teachers entered the profession via the traditional route (i.e., these teachers graduated from a teacher preparation institution and completed a student teaching experience). In comparison, 12 first-year teachers entered the profession via an alternative route (i.e., these teachers graduated with a degree other than agricultural education and did not complete a teacher preparation program).

The largest number of first-year teachers who were traditionally certified reported being 21 to 25 years of age (59%) (Table 1).

Table 1

Personal Characteristics of First-year Secondary Agricultural Education Teachers in Oklahoma by Certification Type (N = 46)

Variable	Traditionally Certified (n = 34)		Alternatively Certified (n = 12)	
	F	%	f	%
Age				
21 – 25 years	20	58.5	2	16.7
26 – 30 years	5	14.7	8	66.7
31 – 35 years	4	11.7	--	--
36 – 40 years	2	5.9	--	--
Over 40 years	3	8.8	1	8.3
Missing	--	--	1	8.3
Sex				
Male	29	85.3	9	75.0
Female	5	14.7	3	25.0
Degree				
Bachelor's	32	94.1	12	100.0
Master's	2	5.9	--	--

Five first-year teachers indicated they were 26 to 30 (15%) years of age, and nine (26%) were 31 years of age or older. Slightly more than 85% (f = 29) of the traditionally certified teachers were male. An overwhelming majority (94%) had a bachelor's degree as the highest degree earned; however, two (6%) had earned a master's degree. In comparison, two-thirds (67%) of the AC

teachers were between the ages of 26 and 30 years. Three-fourths of the first-year AC teachers ($f = 9$) were male. And, all 12 AC teachers had earned a bachelor's degree only (Table 1).

Objective two sought to describe the level of teacher self-efficacy (e.g., student engagement, instructional practices, classroom management) of first-year teachers at the beginning and end of their entry-year of employment by certification type. This study found that an increase occurred in all constructs of teacher self-efficacy when comparing traditionally and AC teachers on the fall and spring semester data collection periods (Table 2).

Table 2

First-year Agricultural Education Teachers' Self-Efficacy at the Beginning and End of their Entry-Year of Employment (N = 46)

Efficacy Constructs	Fall Semester (August 2007)		Spring Semester (May 2008)		Total Change Difference
	<i>M</i>	<i>SD</i>	<i>M</i>	<i>SD</i>	
Student Engagement	6.63	.76	6.67	.86	+ .04
Traditionally Certified	6.67	.73	6.64	.80	- .03
Alternatively Certified	6.47	.92	6.76	1.03	+ .19
Instructional Practices	6.93	.80	7.04	.92	+ .11
Traditionally Certified	7.03	.80	7.02	1.00	- .01
Alternatively Certified	6.48	.68	7.07	.72	+ .59
Classroom Management	7.07	.93	7.23	.89	+ .16
Traditionally Certified	7.03	.97	7.20	.84	+ .17
Alternatively Certified	7.27	.79	7.28	1.06	+ .01

Note. Scale: "1" = "Nothing," "3" = "Very Little," "5" = "Some Influence," "7" = "Quite A Bit," and "9" = "A Great Deal"

Entry-year teachers had the highest increase in efficacy in the area of classroom management (+.16) (Table 2). Of note, this construct also represented teachers' highest level of efficacy on all three constructs during both the fall ($M = 7.07$, $SD = .93$) and spring semesters ($M = 7.23$, $SD = .89$). Instructional practices was the next highest efficacy construct (+.11) for teachers during the fall ($M = 6.93$, $SD = .80$) and spring semesters ($M = 7.04$, $SD = .92$). Entry-year teachers experienced the least amount of growth associated with the student engagement construct (+.04). This construct also represented teachers' lowest level of efficacy regarding all three constructs during the fall ($M = 6.63$, $SD = .76$) and spring semesters ($M = 6.67$, $SD = .86$) (Table 2).

When considering certification types, traditionally certified teachers' level of self-efficacy decreased in the student engagement (-.03) and instructional practices (-.01) constructs and increased by .17 in the classroom management construct during the course of the school year (Table 2). However, AC teachers' self-perceived levels of teacher self-efficacy increased in all three constructs during the course of the school year (i.e., student engagement = +.19; instructional practices = +.59; and classroom management = +.01).

Objective three sought to describe the level of job satisfaction of first-year teachers at the beginning and end of their entry-year of employment by certification type. When assessing overall job satisfaction of entry-year teachers, no difference was detected throughout the course of the year ($M = 3.10_{\text{fall}}$; $M = 3.10_{\text{spring}}$) (Table 3). However, when comparing by certification type, traditionally certified teachers increased their job satisfaction only very slightly (i.e., .02), and AC teachers had a slight decrease (i.e., -.08) in job satisfaction during the course of the academic year. Both groups' mean scores indicated these first-year teachers were undecided on their level of job satisfaction in regard to teaching secondary agricultural education (Table 3).

Table 3

First-year Agricultural Education Teachers' Level of Job Satisfaction at the Beginning and End of their Entry Year of Employment (N = 46)

Job Satisfaction Index	Fall Semester (August 2007)		Spring Semester (May 2008)		Total Change Difference
	<i>M</i>	<i>SD</i>	<i>M</i>	<i>SD</i>	
Overall Job Satisfaction	3.10	.19	3.10	.13	0.00
Traditionally Certified	3.09	.19	3.11	.15	+.02
Alternatively Certified	3.17	.23	3.09	.08	-.08

Note. Scale: "1" = "Strongly Disagree," "2" = "Disagree," "3" = "Undecided," "4" = "Agree," and "5" = "Strongly Agree"

Objective four was to compare university supervisors' end of year assessments of first-year teachers' classroom teaching performance by certification type. In all performance standards of the RTOI, traditionally certified teachers outperformed their AC counterparts by nearly a one-half point margin or more (Table 4). A statistically significant difference ($p < .05$) was found between traditionally and AC teachers regarding student achievement indicators; therefore, the null hypothesis was rejected. In the case of teacher management indicators, teacher instructional indicators, and teacher products, no differences were noted between certification types; so, those null hypotheses were not rejected. Further, when considering Cohen's d as a measure of effect size, it was noted that three of the four constructs (i.e., teacher instructional indicators, teacher products, and student achievement indicators) demonstrated a "large" effect (Cohen, 1988).

Table 4

University Supervisors' Assessments of First-year Teachers by Certification Type at End of the Entry-Year

Performance Standards	<i>F</i>	<i>M</i>	<i>SD</i>	<i>t</i> -value	<i>p</i> -value	Cohen's <i>d</i>
Teacher Management Indicators						
Traditionally Certified	17	2.56	.47	1.70	.23	.72
Alternatively Certified	6	2.13	.70			
Teacher Instructional Indicators						
Traditionally Certified	17	2.39	.35	2.72	.12	1.37
Alternatively Certified	6	1.78	.52			
Teacher Products						
Traditionally Certified	17	2.35	.56	3.33	.65	1.54
Alternatively Certified	6	1.44	.62			
Student Achievement Indicators						
Traditionally Certified	16	2.23	.43	2.95	.00*	1.14
Alternatively Certified	6	1.33	1.03			

Note. * $p < .05$; Scale: "0" = "Strongly Disagree," "1" = "Disagree," "2" = "Agree," and "3" = "Strongly Agree"

Additionally, a comparison of the teacher management indicators construct yielded a "medium" effect size (Cohen) regarding teacher certification route. So, in the case of all four constructs, traditional certification hold "practical significance" regarding university supervisors' assessments of entry-year teachers' performance (Table 4).

Objective five sought to compare teacher self-efficacy and teaching status (i.e., retention) by certification type. To achieve this objective, a Chi-square analysis was conducted. As such, it was found that 59% ($f = 20$) of traditionally certified teachers were still teaching compared to 17% ($f = 2$) of AC teachers (Table 5). This difference was statistically significant ($p < .05$); so, the null hypothesis ($H_0: \mu_1 \text{ traditionally certified} = \mu_2 \text{ alternatively certified}$) was rejected.

Table 5

Relationship between Teacher Self-Efficacy and Teaching Status

Teaching Status	<i>f</i>	%	Chi-value	<i>p</i> -value
Traditionally Certified (<i>n</i> = 34)			6.32	.01*
Currently teaching	20	58.82		
No longer teaching	14	41.18		
Alternatively Certified (<i>n</i> = 12)				
Currently teaching	2	16.67		
No longer teaching	10	83.33		

Note. * $p < .05$

Conclusions

The purpose of this study was to assess the level of teacher self-efficacy and job satisfaction of first-year secondary agricultural education teachers in Oklahoma at the beginning and end of their entry-year in the profession. Further, this study sought to compare traditionally and AC teachers on university supervisors' assessment scores regarding their teaching. The largest number of first-year teachers, who were traditionally certified, were between 21 and 25 years of age, and the largest number of first-year teachers, who were alternatively certified, were between 26 and 30 years of age. Rocca and Washburn (2005) found that AC teachers in Florida were roughly ten years older than their traditionally certified counterparts. Although this study did not find that large of an age difference, the AC teachers were the older group.

In regard to teacher self-efficacy, entry-year teachers increased their level of efficacy on all three constructs (student engagement, instructional practices, and classroom management) during the course of the school year. Specifically, traditionally certified teachers had higher beginning scores on two of the three constructs (student engagement and instructional practices) as compared to their AC counterparts. However, AC teachers perceived the largest amount of perceived growth in student engagement and instructional practices during the year. This finding is consistent with Roberts and Dyer (2004) who noted that AC teachers had the highest mean scores on teacher self-efficacy as compared to their traditionally certified counterparts.

When accounting for the three teacher self-efficacy constructs, AC teachers experienced the largest amount of perceived growth in instructional practices. This finding also resonates with research conducted by Roberts and Dyer (2004) who found that AC teachers perceived they had the lowest in-service needs in the area of instruction and curriculum. Traditionally certified teachers perceived more growth in classroom management than their AC counterparts. In all, AC teachers perceived growth in all three constructs. So, it was concluded that AC teachers perceived they achieved the most positive change in teacher self-efficacy from the start of the school year to its end.

Although AC teachers had higher perceived efficacy scores throughout the year, they did not receive the highest performance scores based on their university supervisor assessments. In fact, traditionally certified teachers outperformed their AC counterparts by an approximate margin of one-half point on each construct (Table 4). Further, when comparing teacher self-efficacy with retention in the profession, it was found that, statistically, AC teachers were more apt to leave the profession than were their traditionally certified counterparts. The largest margin of difference was found on teacher products (i.e., lesson plans and assessments) (Table 4). Moreover, a statistically significant difference existed when comparing traditionally certified and AC teachers on their ability to perform student achievement indicators, with traditionally certified teachers performing better overall.

Limitations

Although this study was performed in a rigorous manner, several limitations exist. As such, the reader is cautioned about generalizing beyond this study's population. Specifically, the RT program is the only induction program in place in Oklahoma currently. As such, this study was limited to first-year teachers in Oklahoma during the 2007-2008 school year. Further, the researchers acknowledge that "liberty" was taken in using inferential statistics. However, the researchers relied on the "time and place sample" rationale provided by Oliver and Hinkle (1982) to support the use of inferential statistics.

Although the researchers attempted to ensure no significant differences existed between raters who provided supervision to the first-year teachers studied, it should be noted that the raters were assigned to their teachers. No two raters observed the same teacher. Therefore, measurement errors occurred undoubtedly. Finally, it is noted that incomplete data sets were relied on for the study's data analyses. Further, not all first-year teachers were employed at the beginning of the year when one of the instruments was disseminated. And, not all teachers remained employed until the year was complete. So, the number of individuals who participated in this study varied throughout the year.

Recommendations for Research

Because teacher shortage is a critical concern to the agricultural education profession, further research should include determining whether or not teacher self-efficacy and job satisfaction can be attributed to long-term teacher retention. Also, self-assessments can be problematic. So, further research should be conducted with school administrators, parents, and even students to determine the needs and abilities of entry-year teachers better. Feedback from these individuals could be tied to Bandura's social persuasion source of teacher self-efficacy (Bandura, 1997). In addition to social persuasion, other sources of teacher self-efficacy (e.g., mastery experiences, physiological and emotional states, and vicarious experiences) should be studied through the lens of agricultural education teachers. Which experiences, of these sources, are most crucial to the improvement and demise of teacher self-efficacy for agriculture teachers? Understanding this phenomenon better could improve teacher effectiveness and, perhaps, longevity.

Also, research should occur to determine why these first-year teachers are undecided as to their level of job satisfaction. Boverie and Kroth (2000) stated that this generation of individuals is not as concerned with job tenure as compared to previous generations. In fact, today's graduates are more apt to "job hop" from one profession to the next (Boverie & Kroth). Even so, it is crucial

that while in the profession, these teachers enjoy their job and have confidence in their abilities to perform at a high level.

It could be assumed that over time and through experiences, an individual's self-efficacy would improve vis-à-vis his or her performance of various tasks (Bandura, 1993). Therefore, it was interesting that traditionally certified teachers decreased in their self-efficacy in regard to student engagement and instructional practices from the beginning of the school year to its end. Why was that? Perhaps these teachers could benefit from professional development that emphasizes student-centered teaching approaches. Further research (e.g., qualitative interviews) should be conducted to determine what caused this decline in teacher self-efficacy.

Finally, this study should be replicated with the intention to determine how school size and administrative support influence teacher retention and job satisfaction. Coladarci (1992) found that these variables predicted teacher commitment. However, do they predict teacher job satisfaction and retention? Although this study assessed only those teachers in the profession currently, follow-up qualitative interviews should be conducted with teachers who left the teaching profession to explore this rationale for exiting.

Recommendations for Practice

Prolonged, sustained professional development calibrated to assist all teachers with their professional self-efficacy should occur. Special attention should be devoted to assisting AC teachers improve student achievement in the classroom and laboratory settings. Further, inservice workshops should also exist to inform AC teachers on the importance of developing appropriate teacher products (i.e., lesson plans, examinations, and assessments). A focus for these teachers should be on the process of lesson planning. Because AC teachers have not had pedagogical preparation, they may not know how to create the products necessary to be effective classroom and laboratory educators. However, with proper professional development, the creation of such teacher products can be improved, which could assist in increasing student achievement overall.

Further, two of the four sources of teacher self-efficacy are vicarious experiences and social persuasion (Bandura, 1994). Vicarious experiences involve observing others succeed at performing a task. Social persuasion involves others convincing a "novice" that he or she has the ability to perform a given task well. As such, all teachers could benefit from additional observations and critiques of their instruction. However, because AC teachers have not experienced the student teaching process and have missed the opportunity to receive vicarious experiences and social persuasion, they are most in need of these experiences. Therefore, efforts should be devoted to assisting AC teachers in developing a network of colleagues who can mentor them during difficult times throughout the school year. AC teachers could be provided opportunities for observational experiences via "externships." In essence, AC teachers need to be able to observe veteran teachers instructing students in the field. Watching and emulating the behaviors of credible teachers as they conduct class, manage unruly students, and plan lessons could improve these teachers' "actual" levels of teacher self-efficacy.

Finally, with the current federal administration focused on the *Educate to Innovate* initiative, "teacher quality" accountability is needed in today's school systems now more than ever (The White House, 2009). Teacher educators should continue to address ways of developing and

advancing human capital necessary to improve, validate, and assess teacher quality. Teacher self-efficacy and performance measures related to student learning should be monitored continually to understand better the deficiencies that exist in teacher preparation programs. Once identified, professional development should be delivered for the purpose of providing more competent and qualified teachers in the education workforce.

Implications

It could be assumed that traditionally certified teachers would have higher levels of teacher self-efficacy when compared to AC teachers (Roberts & Dyer, 2004). However, this study did not support that assumption. Why not? Perhaps this finding can be explained by the fact that traditionally certified teachers have received pedagogical preparation and are therefore more critical of their performance because they know what “should be” expected of them (Rocca & Washburn, 2005). Conversely, AC teachers have more room to improve perhaps because of their lack of pedagogical preparation and understanding. Accordingly, the “ceiling” may be higher regarding their room for improvement. These findings support research by Roberts and Dyer (2004) who suggested that simply, AC teachers “don’t know what they don’t know.”

References

- Bandura, A. (1977). Self-efficacy: Toward a unifying theory of behavioral change. *Psychological Review*, 84, 191–215.
- Bandura, A. (1993). Perceived self-efficacy in cognitive development and functioning [Electronic Version]. *Educational Psychologist*, 28(2), 117–148.
- Bandura, A. (1994). Self-efficacy. In V. S. Ramachaudran (Ed.), *Encyclopedia of human behavior* (Vol. 4, pp. 71–81). New York, NY: Academic Press.
- Bandura, A. (1997). *Self-efficacy: The exercise of control*. New York, NY: W. H. Freeman and Company.
- Blackburn, J. J. (2007). *An assessment of teacher self-efficacy and job satisfaction of early career Kentucky agriculture teachers*. Unpublished dissertation. University of Kentucky, Lexington. Retrieved from http://archive.uky.edu/bitstream/10225/693/blackburn_thesis.pdf
- Blackburn, J. J., & Robinson, J. S. (2008). Assessing teacher self-efficacy and job satisfaction of early career agriculture teachers in Kentucky. *Journal of Agricultural Education*, 49(3), 1–11. doi: 10.5032/jae.2008.03001
- Boverie, P., & Kroth, M. (2000). A passion for work: Developing and maintaining motivation. *Motivation Symposium 33*, Raleigh-Durham, NC.
- Brayfield, A. H., & Rothe, H. F. (1951, October). An index of job satisfaction. *Journal of Applied Psychology*, 35, 305–311.
- Bruinsma, M., & Jansen, E. P. W. A. (2010). Is the motivation to become a teacher related to pre-service teachers’ intentions to remain in the profession? *European Journal of*

Teacher Education, 33: 2, 185–2000. doi: 10.1080/02619760903512927. Retrieved from <http://dx.doi.org/10.1080/02619760903512927>

- Cano, J., & Miller, G. (1992a). A gender analysis of job satisfaction, job satisfier factors, and job dissatisfier factors of agricultural education teachers. *Journal of Agricultural Education*, 33, 40–46.
- Cano, J., & Miller, G. (1992b). An analysis of job satisfaction and job satisfier factors among six taxonomies of agricultural education teachers. *Journal of Agricultural Education*, 45, 9–16.
- Chapman, D. W. (1984). Teacher retention: The test of a model [Electronic Version]. *American Educational Research Journal* 21(3), 645–658. doi: 10.3102/00028312021003645
- Cohen, J. (1988). *Statistical power for the behavioral sciences* (2nd ed.). Hillsdale, NJ: Erlbaum.
- Coladarci, T. (1992). Teachers' sense of efficacy and commitment to teaching. *Journal of Experimental Education*, 60(4), 323–337.
- Darling-Hammond, L., & Sykes, G. (2003). Wanted: A national teacher supply policy for education: The right way to meet the “highly qualified teacher” challenge. *Education Policy Analysis Archives*, 11(33). Retrieved from <http://epaa.asu.edu/epaa/v11n33/>.
- Duncan, D. W., & Ricketts, J. C. (2008). Total program efficacy: A comparison of traditionally and alternatively certified agriculture teachers. *Journal of Agricultural Education*, 49(4), 38–46. doi: 10.5032/jae.2008.04038.
- Feistritzer, C. E., & Haar, C. K. (2008). *Alternative routes to teaching*. Upper Saddle River, NJ: Pearson.
- Good, T. L., McCaslin, M., Tsang, H. Y., Zhang, J., Wiley, C. R. H., Bozack, A. R., & Hester, W. (2006). How well do 1st-year teachers teach: Does type of preparation make a difference? *Journal of Teacher Education*, 57(4), 410–430.
- Hess, F. M. (2000). Tear down this wall: The case for a radical overhaul of teacher certification. *Educational Horizons*, 169–183.
- Hoy, W. K., & Miskel, C. G. (2005). *Educational administration: Theory, research, and practice* (7th ed.). Boston, MA: McGraw-Hill.
- Ingersoll, R. M. (2001). Teacher turnover and teacher shortages: An organizational analysis [Electronic Version]. *American Educational Research Journal* 38(3), 499–534. doi: 10.3102/00028312038003499
- Kantrovich, A. (2007). *A national study of the supply and demand for teachers of agricultural education in 2004-2006*. Morehead, KY: Morehead State University.

- Lynch, R. L. (1996). In search of vocational and technical teacher education. *Journal of Vocational and Technical Education*, 13(1). Retrieved from <http://scholar.lib.vt.edu/ejournals/JVTE/v13n1/lynch.html>
- Oklahoma Commission for Teacher Preparation. (n.d.). General competencies for licensure. Retrieved from http://www.ok.gov/octp/Program_Accreditation/Accreditation/General_Competencies_for_Licensure.html
- Oliver, J. D., & Hinkle, D. E. (1982). Occupational education research: Selecting statistical procedures. *Journal of Studies in Technical Careers*, 4(3), 199–208.
- Osborne, E. W. (Ed.) (n.d.). *National research agenda: Agricultural education and communication, 2007–2010*. Gainesville, FL: University of Florida, Department of Agricultural Education and Communications.
- Roberts, T. G., & Dyer, J. E. (2004). Inservice needs of traditionally and alternatively certified agriculture teachers. *Journal of Agricultural Education*, 45(4), 57–70.
- Robinson, J. S. (2010). A qualitative analysis of alternatively certified agricultural education teachers on their first year of employment in the teaching profession. *Journal of Southern Agricultural Education Research*, 60(2), 25–39. Retrieved from <http://www.jsaer.org/pdf/Vol60/2010-60-003.pdf>
- Rocca, S. J., & Washburn, S. G. (2006). Comparison of teacher efficacy among traditionally and alternatively certified agriculture teachers. *Journal of Agricultural Education*, 47(3), 58–68.
- Rots, I., Aelterman, Vlerick, P., & Vermeulen, K. (2007). Teacher education, graduates' teaching commitment and entrance into the teaching profession. *Teaching and Teacher Education*, 23, 543–556.
- Ruhland, S. K. (2001). Factors that influence the turnover and retention of Minnesota's technical college teachers [Electronic Version]. *Journal of Vocational Education Research* 26(1), 1–15. Retrieved from <http://chuma.cas.usf.edu/~spector/scales/jsspag.html>
- Ruhland, S. K., & Bremer, C. D. (2002). *Alternative teacher certification procedures and professional development opportunities for career and technical education teachers*. St. Paul, MN: The National Research Center for Career and Technical Education. Retrieved from <http://www.nccte.org/publications/infosynthesis/r&>
- Shoho, A. R., & Martin, N. K. (1999). *A comparison of alienation among alternatively and traditionally certified teachers*. Paper presented at the meeting of the American Educational Research Association, Montreal, Quebec, Canada.
- Steadman, S. C., & Simmons, J. S. (2007). The cost of mentoring non-university-certified teachers: Who pays the price? *Phi Delta Kappan*, 364–367.

The White House. (2009). President Obama Launches “Educate to Innovate” Campaign for Excellence in Science, Technology, Engineering & Math (Stem) Education. Retrieved from <http://www.whitehouse.gov/the-press-office/president-obama-launches-educate-innovate-campaign-excellence-science-technology-en>

Tschannen-Moran, M., & Woolfolk Hoy, A. (2001). Teacher efficacy: Capturing an elusive construct. *Teaching and Teacher Education* 17, 783–805.

Tschannen-Moran, Woolfolk Hoy, A. Hoy, W. K. (1998). Teacher efficacy: Its meaning and measure. *Review of Educational Research*, 68(2), 202–248.

Warner, P. D. (1973). *A comparative study of three patterns of staffing within the cooperative extension organization and their association with organizational structure, organizational effectiveness, job satisfaction, and role conflict*. Unpublished doctoral dissertation, Ohio State University, Columbus.

Woolfolk Hoy, A., & Spero, R. B. (2005). Changes in teacher efficacy during the early years of teaching: A comparison of four measures. *Teaching and Teacher Education*, 21, 343–356. doi: 10.1016/j.tate.2005.01.007

Young, R. B., & Edwards, M. C. (2006). A comparison of student teachers’ perceptions of important elements of the student teaching experience before and after a 12-week field experience. *Journal of Agricultural Education*, 47(3), 45–57. doi: 10.5032/jae.2006.03045

Entry-level Technical Skills that Teachers Expected Students to Learn through Participation in the Supervised Agricultural Experience (SAE) Component of Secondary Agricultural Education: A Modified Delphi Study

*Jon W. Ramsey, Oklahoma State University,
M. Craig Edwards, Oklahoma State University*

Abstract

Supervised experiences are designed to provide opportunities for hands-on learning of skills and practices that lead to successful personal growth and future employment in an agricultural career (Talbert, Vaughn, Croom, & Lee, 2007). In the Annual Report for Agricultural Education (2005-2006), it was reported that, 91% of the respondents (i.e., students) indicated they did not have an SAE. This finding was not surprising entirely because some scholars and practitioners of agricultural education have reported empirically and anecdotally that the SAE component of the model was perhaps losing ground in many agricultural education programs (Dyer & Osborne, 1995; Wilson & Moore, 2006). The decline in delivery of this facet of the model has implications regarding agricultural education's role in the preparation of students for entry-level jobs in the agricultural industry. In some instances, the learning experiences being taught in the secondary agricultural education program may not be congruent with today's agricultural industry standards. This incongruence may be a contributing factor to the decline in students who actively participate in SAEs. This study used a modified Delphi technique to coalesce the views of an expert panel of agricultural education teachers on the role of SAEs in preparing students for entry-level careers in the agricultural industry.

Introduction and Conceptual Framework

SAE is the part of agricultural education that allows students to practice in a work setting (placement) or an entrepreneurial (ownership) environment what they have learned in the classroom or laboratory (Talbert et al., 2007). These work-based learning experiences are a component of agricultural education that sets it apart from many other programs or subjects in most secondary schools.

Roberts and Ball (2009; Figure 1) reported that a review of early secondary agricultural education curricula revealed its focus was on the development of specific skills. This behaviorist framework for content-centered secondary agricultural education has been the foundation for much of its curriculum (Phipps, Osborne, Dyer, & Ball, 2008; Talbert et al., 2007), which has focused on preparing skilled workers for the industry of agriculture.

SAE is one of the critical components of secondary agricultural education's "three-circle" model of program delivery. Agricultural education's proponents have touted the benefits of this critical component of the program because it includes acceptance of responsibility, development of self-confidence, opportunity to learn independently, development of independence, and learning to work with others as student learning experiences (Pals, 1988). In so far as students developing favorable work attitudes, Dyer and Williams (1997) spoke to the knowledge and skills students acquire in that regard through SAE placement opportunities particularly.

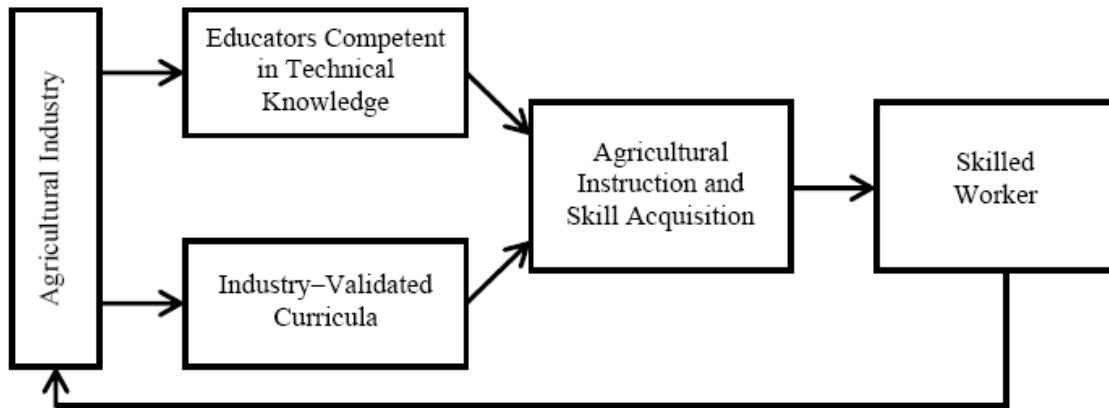

Figure 1. A content-based model for teaching agriculture (Taken from Roberts & Ball, 2009)

The abovementioned content-based model of teaching agriculture would resonate with the early proponents of vocational education. Stimson’s project method of teaching and Prosser’s focus on industry specific training can be found in both the “industry-validated curricula” and the emphasis placed on “agricultural instruction and skill acquisition” (Roberts & Ball, 2009). Regarding a model of secondary agricultural education that focuses on the “melding” or integrating of classroom and laboratory instruction, youth development, and experiential learning, an observer can identify easily opportunities for skill acquisition occurring through secondary agricultural education’s hallmark experiential learning component, SAE.

However, the decline in delivery of this facet of the model (Baggett-Harlin & Weeks, 2000; Dyer & Osborne, 1995; Rayfield & Wilson, 2009; Steele, 1997) has implications regarding agricultural education’s role in the preparation of students for entry-level positions in the agricultural industry. For example, the skills being learned may not be congruent with the needs of today’s agricultural industry. This discrepancy may be contributing to a decline in students participating in SAEs. However, little is known about reasons for that “decline,” especially empirically.

Today’s workplace reflects the many changes that have occurred over the past century, from emergence of the information age to the shift to a global economy; accordingly, the workplace requires a different set of skills (Ruffing, 2006). The career cluster Agriculture, Food and Natural Resources (AFNR) consists of seven career pathways that can be used to facilitate students acquiring the skills needed for entry-level employment in the 21st century (Oklahoma Department of Career and Technology Education [ODCTE], 2009; Ruffing, 2006). Federal lawmakers, through authorization of Perkins IV legislation, called for the development of “programs of study” at both secondary and post-secondary levels that would be aligned with industry-recognized standards (Carl D. Perkins Career and Technical Education Improvement Act of 2006, p. 683). These “career pathways are programs of academic and technical study that integrate classroom and real-world learning organized around industry” (Hoachlander, 2008, p. 23). However, little is known about the views of agricultural education teachers, who prepare students for the AFNR career cluster, regarding the role of SAE and its potential for helping students acquire entry-level technical skills.

Purpose and Objectives

The purpose of this study was to describe the perceptions of a select group of agricultural education teachers (i.e., an expert panel) regarding the entry-level technical skills they expected students to learn through their participation in the SAE component of secondary agricultural education in Oklahoma. A modified Delphi technique was used to achieve this purpose. The following objectives guided the study: 1) describe selected personal and professional characteristics of secondary agricultural education teachers who comprised the study's Delphi panel; 2) describe the perceptions of panelists regarding the SAE component of the secondary agricultural education model as related to the technical skill acquisition of Oklahoma students preparing for entry-level positions in the agricultural industry, using the seven career pathways as an exploratory framework; 3) suggest career pathways in which students should learn entry-level skills through participation in SAEs such that their job preparedness on entering the agricultural industry in Oklahoma is enhanced. Accordingly, Roberts' and Ball's (2009) content-based model for teaching agriculture would be explored regarding its relevance to students' SAEs.

Methods and Procedures

This was a descriptive study that employed a survey research design using the Delphi technique (Sackman, 1975). The Delphi technique is a widely accepted method for achieving convergence of opinion concerning real-world knowledge solicited from experts in certain topic areas (Hsu & Sandford, 2007). Linstone and Turoff (1975) characterized the Delphi technique as a communication process structured to produce a detailed examination of a topic/problem and discussion from the participating group (i.e., expert panel), but not one that forces a quick compromise. The purpose of the Delphi technique is to gather responses from an expert panel and combine the responses into one useful statement or "position" (Stitt-Gohdes & Crews, 2004).

A review of the *Journal of Agricultural Education* from 2000 to 2006 revealed eight studies that relied on the Delphi technique to evaluate a variety of topics of importance to agricultural education researchers. To that end, the Delphi technique has been accorded a reasonable degree of acceptance; e.g., the technique has been used in the area of curriculum planning and the identification of personal qualities of student leaders (Martin & Frick, 1998). Regarding SAE, Camp, Clarke, and Fallon (2000) used the Delphi technique to examine the efficacy and structure of SAE for the 21st century.

Purposeful sampling was used to select members for the study's expert panel. Creswell (2005) defined purposeful sampling as "a qualitative sampling procedure in which researchers intentionally select individuals and sites to learn or understand the central phenomenon" (p. 359). This design allows for development of consensus on a number of issues without face-to-face confrontation (Helmer, 1966). According to Dalkey, Rourke, Lewis, and Snyder (1972), when a Delphi panel has at least 15 members and is truly representative of the expert community, the method is reliable. For this study, a panel of secondary agricultural education teachers, representing the Oklahoma Agricultural Education Teachers Association (OAETA), was used.

To ensure statewide representation, service on the OAETA Board of Directors served as the criteria for selection as a panelist: president, past president, president-elect, secretary,

treasurer-reporter, district vice-presidents, and one and two-year directors. Nineteen active agricultural education teachers who held offices in Oklahoma's state level professional organization for agricultural education teachers were members of the teacher panel. Each office is filled through a nomination process and a majority vote of teachers representing each agricultural education district in the state of Oklahoma. The panel selection process was used to determine the sample "because the success of the Delphi relies on the informed opinion" of recognized experts (Wicklein, 1993, p. 1050) and not the use of random selection.

Agricultural education faculty members at Oklahoma State University established content and face validity for the initial instrument used in this study. One of the original researchers who developed the Delphi technique, i.e., Dalkey (1969), stated that reliability of .7 or greater could be achieved when the expert panel consisted of 11 members or more. After further use of the Delphi technique, Dalkey et al. (1972) indicated that a group size of 13 was needed for reliability with a correlation coefficient of .9. Therefore, Dalkey et al. recommended a group size of twelve to fifteen panelists. The initial inclusion of 19 secondary agricultural education teachers as panelists contributed to the reliability of the multiple round, modified Delphi procedure.

Personal and professional characteristics unique to the panel of experts were collected: gender, age, years of professional experience, and highest degree earned. Regarding SAEs (or similar 4-H projects), their types, intensity of involvement, and panelists' perceptions of benefits to themselves were also of interest to the researchers. In all, eight items were asked regarding panelists' characteristics. Using the seven career pathways for agricultural education in Oklahoma as a context, panelists were asked to identify entry-level technical skills that should be learned through student participation in the SAE component of secondary agricultural education. In addition, the following explanatory paragraph was included on the round one instrument.

The Oklahoma Department of Career and Technology Education defines SAE programs as teacher-supervised, individualized, hands-on, student developed projects that give students real-world experience in agriculture and/or agriculture related areas (ODCTE, 2009). The seven career pathways for Oklahoma Agricultural Education include 1) Food Products and Processing, 2) Plant and Soil Science, 3) Animal Science, 4) Agricultural Power, Structures and Technology, 5) Agribusiness and Management, 6) Agricultural Communications, and 7) Natural Resources and Environmental Science. Please, focus only on the career pathway(s) that best fits your experience as an agricultural education teacher and represents the SAEs in which your students are involved. Please, list as many skills as you can. (Ramsey, 2009, p. 57)

Electronic "reminder" messages were sent to panelists approximately one week prior to the assigned due date encouraging the return of round one responses. From round one, 555 statements ($n = 19$; 100% response rate) were provided by the Delphi panelists. The researcher analyzed each statement. Similar or duplicate statements (i.e., skills) were combined or eliminated while compound statements were separated. From 555 original statements, 260 were retained for presentation in round two.

Round Two

The round two instrument asked panelists to rate their level of agreement on the retained entry-level technical skills from round one. All panelists were asked to respond to the 260

statements presented in round two. Panelists were asked to use a six-point response scale to rate the skills: “1” = “Strongly Disagree,” “2” = “Disagree,” “3” = “Slightly Disagree,” “4” = “Slightly Agree,” “5” = “Agree,” and “6” = “Strongly Agree”. Electronic “reminder” messages were sent to panelists approximately one week prior to the assigned due date encouraging the return of round two responses. Some preliminary consensus began to form in round two. One hundred forty skills ($n = 16$; 84.2% response rate) received a score of “5” or “6” by 75% or more of the respondents and were considered skills for which consensus was reached. Moreover, 34 skills, for which less than 51% of the respondents scored the item a “5” or “6,” were removed from further investigation (Hsu & Sandford, 2007).

Round Three

Buriak and Shinn (1989) described the third round of a Delphi study as developing consensus. Accordingly, the third round instrument of this study focused on developing consensus for the 86 skills that remained. The panelists were asked to rate their level of agreement for those skills that at least 51% but less than 75% of panelists had selected “Agree” or “Strongly Agree” in round two. The round three instrument included the percentage of panelists who indicated “5” (“Agree”) or “6” (“Strongly Agree”) for that skill in round two. Electronic “reminder” messages were sent to panelists approximately one week prior to the assigned due date encouraging the return of round three responses. Compared to the previous round, only a slight increase in “consensus of agreement” was expected (Anglin, 1991; Dalkey et al., 1972; Jacobs, 1996; Weaver, 1971). However, an additional 21 skills received a score of “5” (“Agree”) or “6” (“Strongly Agree”) by 75% or more of the respondents and were considered skills for which consensus was reached. The remaining 65 skill items failed to reach the established level of agreement for consensus.

The personal and professional characteristics of the Delphi panelists were analyzed using frequencies and percentages. For each skill item in rounds two and three, the frequency distribution valid percentage was used to determine if the item reached consensus (i.e., $\geq 75\%$ of the panelists indicated “Agree” or “Strongly Agree”).

Findings

Of the 19 panelists who completed the round one instrument, 94.7% were male and 5.3% elected not to identify their gender. Fourteen of 19 (73.6%) panelists reported their age to be between 20 and 49 years of age. Five of the 19 (26.4%) panelists reported being 50 years or older. Regarding ethnicity or race, 89.4% of the panelists reported they were Caucasian, 5.3% were Native American, and 5.3% reported being Hispanic. Nearly two-thirds of the panelists reported a bachelor’s degree as their highest level of educational attainment; 36.8% of panelists held a master’s degree. Full-time employment or full-time temporary employment in agriculture was reported by 73.6% of the teachers prior to their careers as educators; 21.0% of teachers reported part-time employment or employment that was “mostly avocational.”

Panelists reported a range of involvement in agricultural youth organizations. Eighty-four percent of the teachers indicated involvement in FFA. Other youth organizations in which teachers reported involvement included 4-H, Youth Livestock Associations, and the American Farmers and Ranchers Organization. Five or more years of participation was reported by 68.4%

of panelists. The remaining panelists reported four, three and two years of participation in an agricultural youth organization. Seventy-eight percent of the panelists indicated they were “very involved” in an agricultural youth organization, 15.8% indicated “above average involvement,” and 5.3% reported “average involvement.” In addition, more than 90% of panelists indicated participation in an SAE/4-H project. The SAE/4-H projects in which panelists participated included “exhibited livestock” (84.2%), “worked in an agriculturally related job” (73.6%), “raised livestock” (73.6%), “raised crops” (47.3%), and “conducted agricultural research/experiments” (15.7%). When asked if participation in SAE/4-H projects led to entry-level technical skill acquisition, 18 of 19 (94.7%) panelists reported “yes.”

Round One Findings: Entry-level Technical Skills

The 555 skills provided by the teacher panelists in round one ranged from “General Safety” to “Identify Wholesale Cuts of Meat.” After accounting for duplicate and compound statements, 260 items were retained for presentation to the Delphi panel in round two. The number of skills identified by pathway were Food Products and Processing (FPP, 35), Plant and Soil Science (PSS, 54), Animal Science (ANSI, 35), Agricultural Power, Structures and Technology (APST, 42), Agribusiness and Management (AGBMGT, 29), Agricultural Communications (AGCM, 35), and Natural Resources and Environmental Science (NRES, 30).

Round Two Findings: Entry-level Technical Skills

In round two, the panelists were asked to rate their level of agreement on 260 entry-level technical skills. The number of items reaching “consensus of agreement” (i.e., $\geq 75\%$ indicated “Agree” or “Strongly Agree”), by pathway, were FPP, 15; PSS, 26; ANSI, 23; APST, 25; AGBMGT, 13; AGCM, 29; and NRES, 9. In total, 140 items reached the level of agreement considered as “consensus” (Table 1).

Round Three Findings: Entry-level Technical Skills

The panelists were asked to rate their level of agreement on 86 entry-level technical skills in round three that had not reached consensus previously. The number of additional items reaching “consensus of agreement,” by pathway, were FPP, 4; PSS, 3; ANSI, 5; APST, 4; AGBMGT, 1 and NRES, 4. Overall, 21 additional skill items reached agreement in round three (Table 1).

After three rounds of the modified Delphi procedure, the total number of entry-level technical skills that reached “consensus of agreement” was 161. The distribution of skills by career pathway was, AGBMGT, 14; AGCM, 29; ANSI, 28; APST, 29; FPP, 19; NRES, 13, and PSS, 29 (Figure 2).

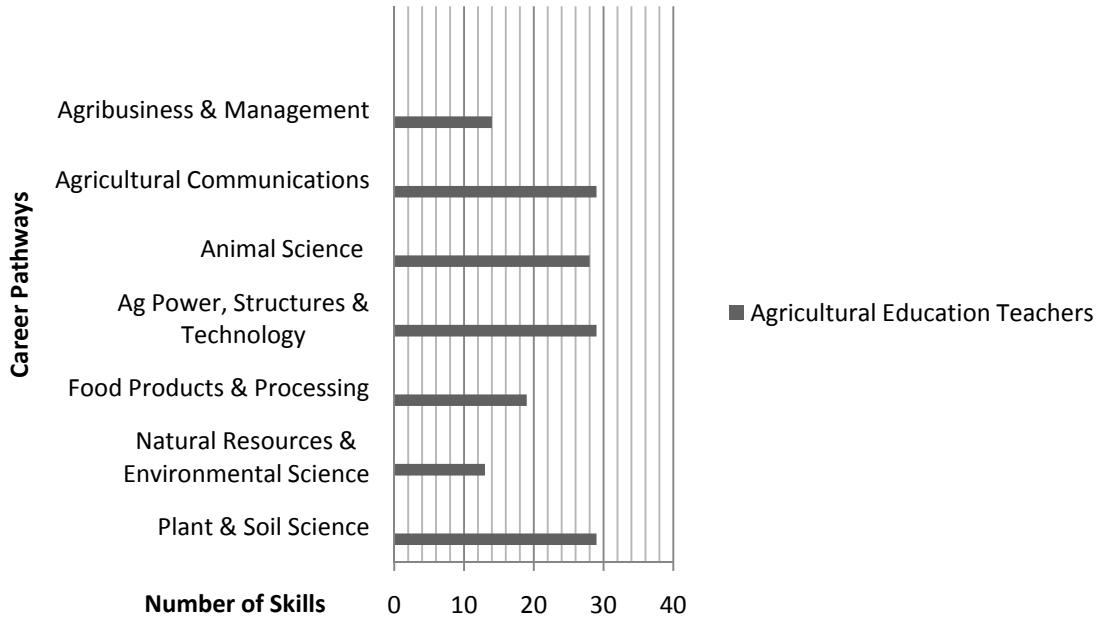

Figure 2. Total Number of Entry-level Technical Skills Reaching “Consensus of Agreement,” as Identified by Career Pathway

Table 1

A Sample of Entry-level Technical Skills Students were Expected to Learn through Their Participation in SAEs that Reached Consensus of Agreement after Three Rounds of a Modified Delphi Study (Ten skills or more, including tied ranks, that received the highest level of agreement are presented by pathway; not all skills that reached consensus are displayed.)

Entry-level Technical Skills	Pathway	% Agreement
Savings accounts	AGBMGT	93.80
Time management	AGBMGT	87.50
Income and expenses	AGBMGT	87.50
Simple interest	AGBMGT	87.50
Time value of money (investments/retirement)	AGBMGT	87.50
Insurance	AGBMGT	87.50
Checking accounts	AGBMGT	81.30
Banking	AGBMGT	81.30
Developing a budget	AGBMGT	81.30
Basic money management	AGBMGT	81.30

(continued)

Entry-level Technical Skills	Pathway	% Agreement
Overall knowledge of agriculture in general	AGCM	100.00
Public speaking	AGCM	93.80
Computer skills	AGCM	93.80
Problem solving	AGCM	93.80
Using powerpoint presentations	AGCM	93.80
Time on task skills	AGCM	93.80
How to interview for a job	AGCM	87.50
How to build a resume	AGCM	87.50
Telephone skills	AGCM	87.50
Contacting local newspapers and radio stations	AGCM	87.50
Chapter publicity	AGCM	87.50
News reporting	AGCM	87.50
Designing flyers	AGCM	87.50
Writing news releases	AGCM	87.50
Using information	AGCM	87.50
Manage an activity budget	AGCM	87.50
Use of word processing equipment	AGCM	87.50
Number of Skills for the Pathway displayed	17	
Administering medications	ANSI	100.00
Livestock selection	ANSI	100.00
Disease identification (animal)	ANSI	100.00
Vaccination (animal)	ANSI	93.80
De-worming	ANSI	93.80
Breeds of livestock	ANSI	93.80
Animal concerns	ANSI	92.90
Record keeping	ANSI	87.50
Proper livestock handling	ANSI	87.50
Animal anatomy	ANSI	87.50
Role of agricultural animals in the 'big picture' of the economy and world	ANSI	87.50
Feed rations	ANSI	87.50
Number of Skills for the Pathway displayed	12	
How to use measuring devices	APST	100.00
How to read a tape measure	APST	93.80
Tool identification	APST	93.80

(continued)

Power equipment usage	APST	93.80
Oxy acetylene welding	APST	92.90

Entry-level Technical Skills	Pathway	% Agreement
Equipment repair (problem solving)	APST	92.90
How to use an abrasive cut-off saw	APST	87.50
How to use a portable drill	APST	87.50
How to use a portable grinder	APST	87.50
How to use a drill press	APST	87.50
Oxy acetylene cutting	APST	87.50
Basic math	APST	87.50
Basic electrical skills	APST	87.50
Project construction	APST	87.50
Types of fuel gasses and uses	APST	87.50
Equipment maintenance	APST	87.50
Number of Skills for the Pathway displayed	16	
How to read and understand a nutrition label	FPP	100.00
Responsibility	FPP	100.00
Decision making	FPP	100.00
General safety	FPP	100.00
People skills	FPP	100.00
Communication	FPP	100.00
Selection of products	FPP	92.90
Safe use of pesticides	FPP	87.50
Recording data (enterprise income, expenses, and production output)	FPP	87.50
Processing procedures for milk	FPP	87.50
Number of Skills for the Pathway displayed	10	
Work skills	NRES	93.80
Identification of all things related to SAE	NRES	87.50
Wildlife habitat recognition	NRES	85.70
Wildlife management	NRES	85.70
Map reading (GPS)	NRES	81.30
Land use	NRES	81.30
Basic knowledge, appreciation for the environment	NRES	81.30
Wildlife conservation	NRES	78.60
Tree identification	NRES	78.60
Water safety and concerns	NRES	75.00

(continued)

Negative environmental impacts on plants	NRES	75.00
Legal land description	NRES	75.00
Role of NRCS and the landowner	NRES	75.00

Entry-level Technical Skills	Pathway	% Agreement
Total Number of Skills for the Pathway	13	
Chemical safety	PSS	93.80
Soil conservation	PSS	93.80
Weed control	PSS	93.80
Farm Safety	PSS	92.90
Crop identification	PSS	87.50
Proper planting techniques	PSS	87.50
Positive environmental impacts on soil	PSS	85.70
Soil testing	PSS	81.30
Plant identification	PSS	81.30
How to take a soil sample	PSS	81.30
Positive environmental impacts on plants	PSS	81.30
Soil uses	PSS	81.30
Soil types	PSS	81.30
Reproduction of plants	PSS	81.30
Soil preparation for particular crops	PSS	81.30
Basic anatomy of plants	PSS	81.30
Soil parts	PSS	81.30
Parts of a plant	PSS	81.30
Number of Skills for the Pathway displayed	18	

Note. Wording represents the panelists' verbatim responses with the exception of editing for spelling in a few cases, and the addition of parenthetical information for improved clarity.

Conclusions

Concerning objective one, a majority of the teacher panelists were Caucasian males who ranged in age from 20 to 49. A majority of panelists identified FFA as the agricultural youth association in which they were most involved as youth. Most panelists reported five or more years of participation in agricultural youth associations; the panelists' predominant level of participation was "very involved." Ninety-five percent of panelists reported participation in SAEs or 4-H projects as youth. A majority of the SAEs or 4-H projects were entrepreneurial; panelists perceived their participation had led to the acquisition of entry-level technical skills.

Regarding objective two, the expert teacher panelists reached "consensus of agreement" on 161 entry-level technical skills that should be learned by students through participating in supervised agricultural experiences (Figure 2). So, it was concluded that a student learning these technical skills could facilitate his or her preparation for an entry-level position in the agricultural industry. The panelists identified Plant and Soil Science, Animal Science, Agricultural Power, Structures and Technology, and Agricultural Communications as career pathways having the most entry-level technical skills that reached "consensus of agreement," 29, 28, 29, and 29 skills, respectively (Figure 2). So, it was concluded that, based on the teacher panelists' perceptions, supervised agricultural experiences held the most potential for students learning entry-level technical skills related to those career pathways (Figure 2; Table 1).

As for objective three, this study identified the career pathways that selected teacher panelists perceived as having the largest number of entry-level technical skills that should be learned by students who participate in the SAE component of secondary agricultural education in Oklahoma. These findings support Roberts' and Ball's (2009) content-based model of teaching agricultural education and expand its relevance to SAE. Specifically, the identification of entry-level technical skills per the seven career pathways for the AFNR career cluster informs the *Agricultural Instruction and Skill Acquisition* component of their model (Figure 1).

Recommendations

Recommendations for Future Research

Teacher panelists identified entry-level technical skills in all seven pathways; however, they reached "consensus of agreement" on significantly fewer entry-level technical skills representing the Food Products and Processing, Agribusiness and Management, and Natural Resources and Environmental Science pathways. If these pathways represent important agricultural employment sectors in Oklahoma (Oklahoma Department of Commerce, 2005), why did the panelists not view SAE as a program component through which students could learn more entry-level technical skills, especially when compared to the four career pathways that garnered the most skill statements? Investigations should be conducted to determine the perceptions of teachers regarding their adoption of career pathways as a context for planning and delivering the secondary agricultural education program. It may be equally important to understand teachers' information sources informing their views on the changing workforce needs in Oklahoma and what that should mean to their programs' educational priorities, including students' SAEs.

Additional studies are required to determine further the components needed to provide a SAE model for teachers that would enhance the job preparedness of students entering the agricultural industry in Oklahoma. Concomitantly, special attention should be paid to Roberts' and Ball's model (Figure 1) such that the complementarity of any future research is additive. Although select entry-level technical skills viewed through the contextual prism of the AFNR Career Cluster have been identified, more understanding is needed to inform the development of a robust and mature model pertaining to students' SAEs.

Recommendations for Future Practice

Teacher educators should make the AFNR Career Cluster and its representative career pathways more transparent to pre-service students during their teacher preparation program. The integration of SAE opportunities throughout the seven career pathways and the opportunities that exist for entry-level technical skill acquisition by students should be emphasized.

State staff members who are responsible for agricultural education should consider facilitating externships that allow teachers to experience industry environments and expectations for entry-level workers. According to Luft (1999), externships help teachers make their instruction more relevant to preparing students for the world of work. Work-based learning experiences are important for teachers and students enrolled in agricultural education. Teachers could use contextual examples from their externship experiences when planning, facilitating, and assessing students' SAEs. Teacher attitudes and expectations influence student participation in SAEs (Dyer & Osborne, 1995). Camp et al. (2000) reported that SAE, as structured then, was a vital component of a comprehensive program of secondary agricultural education. This study

found that the teacher panelists perceived students should learn entry-level technical skills related to employability in the agricultural industry. So, teachers, teacher educators, and state program leaders should continue to facilitate and promote the SAE component of secondary agricultural education. In particular, teachers should consider increasing their collaboration with industry partners to provide worksite placement opportunities for students.

Discussion and Implications

Phipps et al. (2008) described the purpose of agricultural education as preparing people for entry or advancement in agricultural occupations and professions, job creation, and agricultural literacy. The National FFA Organization reported that more than 300 career opportunities in the agricultural science, food, fiber, and natural resources industry existed (2008-2009 Official FFA Manual). A comprehensive program model consisting of classroom and laboratory instruction, FFA, and SAE is used to deliver experiential learning opportunities to students enrolled in secondary agricultural education (Dyers & Osborne, 1995; Roberts & Ball, 2009, Talbert et al., 2007). This study supports using the SAE component of secondary agricultural education to assist students in learning entry-level technical skills. However, not all career pathways were viewed by the study's Delphi panelists as holding or promoting a substantial number of entry-level technical skills.

Manufacturing is one of the top five industries in Oklahoma that account for two-thirds of the state's jobs. Oklahoma's manufacturing industry is driven by processed meat, tire manufacturing, oil and gas field machinery and equipment, air conditioning and heating equipment, and poultry processing (Oklahoma Department of Commerce, 2005). Moreover, of the top 10 agricultural knowledge requirements, "Mechanical" and "Food Production" were identified as the first and second knowledge items needed in the agriculture and food processing industry in Oklahoma. To that end, the findings of this study are incongruent or "imbalanced" with the needs identified by the Governor's Council for Workforce and Economic Development report (Oklahoma Department of Commerce, 2005). Teacher experts reached "consensus of agreement" on only 19 entry-level technical skills for the FPP pathway and 29 skills in the career pathway APST. These are career pathways that could prepare students for entry-level positions in the Mechanical and Food Production sectors of the agriculture and food processing industry in Oklahoma. However, was the teachers' consensus on 19 and 29 skills, respectively, sufficient?

Roberts and Ball (2009) proffered a content-based model for teaching agriculture (Figure 1) relying on industry-relevant instruction that results in observable skill acquisition by students. But how should teachers acquire industry-relevant content knowledge and skills so they, in turn, can facilitate SAEs such that students learn and practice entry-level technical skills sufficiently? Is Luft's (1999) view on "externships" an appropriate answer? What may be other methods or approaches? These questions require further study by agricultural education professionals.

References

- 2008-2009 Official Manual.* (2008). Indianapolis, IN: National FFA Center, National FFA Organization.
- Anglin, G. L. (1991). *Instructional technology past, present and future.* Englewood, CO: Libraries Unlimited Inc.

- Baggett-Harlin, J., & Weeks, W. G. (2000). FFA status of selected agricultural education enrollees in Oklahoma. *Journal of Southern Agricultural Education Research*, 50(1), 160-166.
- Buriak, P., & Shinn, G. C. (1989). Mission, initiatives, and obstacles to research in agricultural education: A national Delphi using external decision makers. *Journal of Agricultural Education*, 30(4), 14-23.
- Camp, W. G., Clarke, A., & Fallon, M. (2000). Revisiting supervised agricultural experience. *Journal of Agricultural Education*, 41(3), 13-22.
- Carl D. Perkins Career and Technical Education Improvement Act (2006) 20, U.S.C. § 2301.
- Creswell, J. W. (2005). *Educational research: Planning, conducting, and evaluating quantitative and qualitative research* (2nd ed.). Upper-Saddle River, NJ: Pearson Education.
- Dalkey, N. C. (1969). *The Delphi method: An experimental study of group opinion*. Santa Monica, CA: The Rand Corporation.
- Dalkey, N. C., Rourke, D. L., Lewis, R., & Snyder, D. (1972). *Studies in the quality of life*. Lexington, MA: Lexington Books.
- Dyer, J. E., & Osborne, E. W. (1995). Participation in supervised agricultural experience programs: A synthesis of research. *Journal of Agricultural Education*, 36(1) 6-14.
- Dyer, J. E., & Williams, D. L. (1997). Benefits of supervised agricultural experience programs: A synthesis of research. *Journal of Agricultural Education*, 38(4), 50-58.
- Helmer, O. (1966). *Social technology*. New York, NY: Basic Books, Inc.
- Hoachlander, G. (2008). Bringing industry to the classroom. *Educational Leadership*, 65(8) 22-27.
- Hsu, C., & Sandford, B. A. (2007). The Delphi technique: Making sense of consensus. *Practical Assessment Research & Evaluation*, 12(10), 1-7.
- Jacobs, J. M. (1996). *Essential assessment criteria for physical education teacher education programs: A Delphi study*. Unpublished doctoral dissertation, West Virginia University, Morgantown.
- Linstone, H. A., & Turoff, M. (Eds.). (1975). *The Delphi method: Techniques and applications*. Reading, MA: Addison-Wesley Publishing Company.
- Luft, V. D. (1999). School to careers: How agricultural education can contribute. *The Agricultural Education Magazine*, 72(3), 20-25.

- Martin, A. G., & Frick, M. J. (1998). The Delphi technique: An informal history of its use in agricultural education research since 1984. *Journal of Agricultural Education*, 39(1), 73-79.
- National Research Agenda 2007-2010. Agricultural Education and Communication. (2007). Gainesville, FL.
- Oklahoma Department of Career and Technology Education. (2009). Agricultural education courses and standards. Retrieved from <http://www.okcareertech.org/aged/ag%20standards1.htm>
- Oklahoma Department of Commerce. (2005). Oklahoma State of the Workforce Report. *Understanding the knowledge and skill gaps impacting the state's key industry sectors*. Governor's Council for Workforce and Economic Development. Retrieved from http://staging.okcommerce.gov/test1/dmdocuments/2005_State_of_the_Workforce_Report_2109051656.pdf
- Pals, D. A. (1988). Value of supervised occupational experience programs as perceived by parents, employers, and vocational agriculture instructors. *Journal of Agricultural Education*, 30(2), 18-25.
- Phipps, L. J., Osborne, E. W., Dyer, J. E., & Ball, A. (2008). *Handbook on agricultural education in public schools* (3rd ed.). Clifton Park, NY: Thomson Delmar Learning.
- Ramsey, J. W. (2009). *Identifying entry-level skills expected by agricultural industry experts and determining teachers' perceptions on whether they are being learned through students' participation in the supervised agricultural experience component of the secondary agricultural education program: A two-panel Delphi study*. Unpublished doctoral dissertation, Oklahoma State University, OK.
- Rayfield, J., & Wilson, E. (2009). Exploring principals' perceptions of supervised agricultural experience, *Journal of Agricultural Education*, 50(1), 70-80. doi: 10.5032/jae.2009.01070
- Roberts, T. G., & Ball A. L. (2009). Secondary agricultural sciences as content and context for teaching. *Journal of Agricultural Education*, 50(1), 81-91.
- Ruffing, K. (2006). *The history of career clusters*. (States Career Clusters Initiative). Retrieved from <http://www.careerclusters.org/publications.php>
- Sackman, H. (1975). *Delphi critique*. Lexington, MA: The Rand Corporation.
- Steele, R. (1997). Analysis of the continuing decline in use of supervised agricultural experience (SAE) in New York state. *Journal of Agricultural Education*, 38(2), 49-58.

- Stitt-Gohdes, W. L., & Crews, T. B. (2004). The Delphi technique: A research strategy for career and technical education. *Journal of Career and Technical Education, 20*(2), 55-67.
- Talbert, B. A., Vaughn, R., Croom, B. D., & Lee, J. S. (2007). *Foundations of agricultural education* (2nd ed.). Danville, IL: Professional Educators Publications.
- Weaver, W. T. (1971). *The Delphi forecasting method. Phi Delta Kappan, 52*(5), 267-273.
- Wicklein, R. C. (1993). Identifying critical issues and problems in technology education using a modified-Delphi technique. *Journal of Technology Education, 5*(1), 1045-1064.
- Wilson, E., & Moore, G. (2006). Walking the talk: Factors related to the motivation of teachers to conduct the SAE component of the high school agricultural education program. *Proceedings of the Southern Agricultural Education Research Conference (SAERC)*. (2006 AAAE Southern Region Conference, CD-ROM, February 4-8, 2006 release.)

Impact of Selected Factors on Perceived Efficacy of Twitter Use by Agricultural Communicators

*Dr. Alyx Shultz, Murray State University;
Dr. Susan Duncan, Dr. Cindy Akers, Dr. Scott Burris, Dr. Todd Brashears,
Texas Tech University*

Abstract

The use of social media and specifically Twitter is a growing trend within agricultural communications. Social media allows individuals to publish content in real-time for little to no cost. This research examined the factors that lead to the perception of successful communication through Twitter. A census was taken of agricultural communicators who were members of 1 or more of 5 professional agricultural communications organizations. Researchers collected data on seven Twitter usage variables. These seven variables were then regressed upon perceived efficacy to send messages and perceived efficacy to receive messages to make two mathematical models to predict perceived efficacy of Twitter communications. The model for sending efficacy had an adjusted R^2 of .215. The model for efficacy of Twitter in receiving messages had an adjusted R^2 of .216. Variables that contributed the most to the models were the use of auxiliary means to access information, the number of followers the individual had, and number the number of accounts followed. Researchers proposed a graphical model to represent communication within Twitter.

Introduction

Historically, the pace, ease, and accuracy of information exchange through person-to-person communication has been a deciding factor in world-changing events. The speed with which Phidippides ran the first marathon, carrying news of an impending attack from Marathon to Athens in 490 B.C. is credited with changing the outcome of the battles that followed and contributing to the economic prosperity of the area that would become modern-day Europe (Ostapuk, n.d.). The romanticized late-night ride of Paul Revere warned colonists of approaching danger and allowed colonists time to take up arms against the British (Paul Revere Memorial Association, 2008). In both cases, people relied on individual-to-individual communication to transmit information.

Social media is the latest mode of individual-to-individual information sharing. Social media allows computer-savvy individuals to write, publish, and distribute their work for little to no cost at unprecedented speed without the interference of a publisher or editor or hard copy communications. Popular tools in social media currently include Web sites including blogs, YouTube videos, and more recently, Twitter (McFedries, 2009).

The launch of Twitter in August 2006 allowed users to answer one simple question: “What are you doing?” Twitter users answer that question in messages of up to 140 characters, called “tweets”, which are then relayed to interested people across the world (About Twitter: About us, 2009). Twitter users can access information posted within the Twitter platform in many ways.

Twitter users can *follow* other users and receive all the tweets that the other user posts. Additionally individuals can use search engines or the Twitter Web site to search for tweets relevant to them, but not necessarily posted by someone they currently follow (Allen, **Abrams**, Meyers, & Shultz, 2010). For the purpose of this research this second method of obtaining information was operationally defined as the use of auxiliary means. The use of auxiliary means includes the use search engines, the search feature on the Twitter Web site, and the use of hashtags. Hashtags are single word keywords added to tweets by the author that are preceded by “#” and identify the topic of the tweet (Allen, **Abrams**, Meyers, & Shultz, 2010).

Two examples of the use of Twitter within the agricultural communications profession include the Ohio Farm Bureau and Agchat. The Ohio Farm Bureau uses Twitter to disseminate information to over 4,400 followers. As of October 2010, over 4,000 messages, or tweets, had been disseminated through the site (Ohio Farm Bureau, 2010) since November 2008. Agchat is an open, public forum that meets once per week on Twitter to discuss agriculture issues. As of October 2010, Agchat had over 7,500 followers (Agchat, 2009). Additionally, the National Pork Board has hosted social media trainings to educate pork producers in the effective use of Twitter to promote pork. Steven Resler, a pork producer who attended the training, concluded the following regarding the use of social media, including Twitter, within agricultural communications: “The industry can help encourage producers to stay ahead of the curve and use social media tools to become advocates to our industry” (Pork Checkoff, 2009, p. 6).

Despite the prevalence of Twitter use by agricultural communicators and its enthusiastic adoption, little research exists concerning the efficacy of Twitter in communicating messages, or in the suitability of existing communication models in representing the flow of communication within Twitter.

Related Literature

Models, and specifically communication models, can be used to describe concepts or theories as a set of steps or phases without degrading the validity of the larger picture they represent (Metts, 2004). Baran and Davis (2006) defined a model as “any representation of a system whether in words or diagrams” (p. 197).

Models offer multiple advantages but are not without limitation. By using a model, complex relationships can be described (Metts, 2004). However, Baran and Davis (2006) noted that the “easiest models to create tend to be too simple and too static” (p. 174).

Mortensen (1972) described models as providing a frame of reference for research efforts and making the structure of complex events more clear. Furthermore, Mortensen penned that the “aim of a model is not to ignore complexity, or to explain it away, but rather to give it order and coherence” (p. 31). Quality models provide researchers with the means to move away from simplistic descriptive research to the more complex explanation or prediction of phenomena.

A wide range of models have been developed to graphically represent the communication process. A model commonly used within applied communications, including agricultural communications, is the Shannon Weaver Mathematical Model designed by Claude Shannon. The model was originally designed to illustrate the most efficient way to transmit telephone electrical signals. The model contains the following five aspects: (a) source, (b) transmitter, (c) channel, (d) receiver, and (e) destination. In revisions of the model, a sixth concept was added: feedback (Weiner, 1967). In the Shannon Weaver Mathematical Model, the source generates a signal that the transmitter picks up and transmits through a channel to the receiver. The receiver converts the communication, or signal, back to the form it was in originally. While not originally designed to be applied outside of the realm of electrical telephone signals, the model

was adapted by researchers, including many in the behavioral sciences, to describe the human communication process (Mortensen, 1972). See Figure 1.

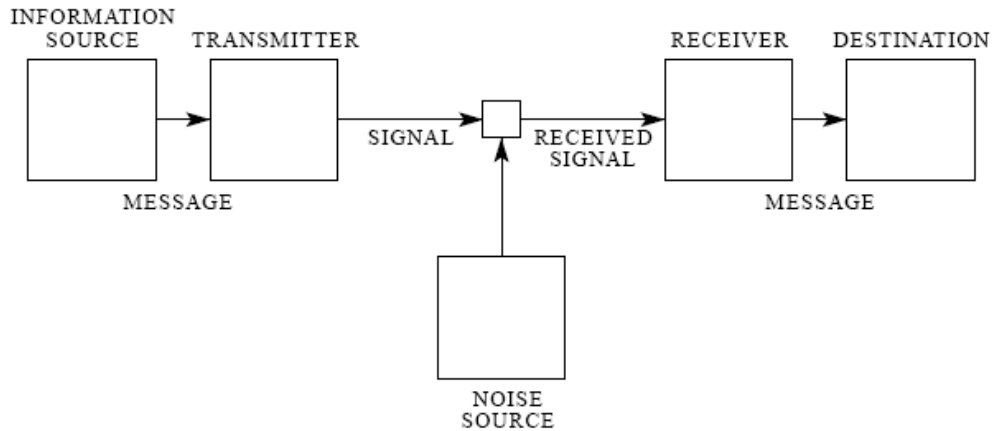

Figure 1. A mathematical model of communication. Adapted from *The Mathematical Theory of Communication*, C. Shannon & W. Weaver, (1949). Urbana, IL: University of Illinois Press.

Berlo (1960) refined the Shannon Weaver Mathematical Model to specifically fit human communications and human behavior. The model emphasized the need to understand human behavior as a component of human communication. This model has been described as “The simplest and most influential message-centered model of our time” (Gronbeck, McKerrow, Ehninger, & Monroe, 1994, p. 502) and as a classic within the field of agricultural communications (Boone, Meisinbach, & Tucker, 2000). See Figure 2.

S Source	M Message	C Channel	R Receiver
Communication Skills	Elements	Seeing	Communication Skills
Attitudes	Content	Hearing	Attitudes
Knowledge	Treatment	Touching	Knowledge
Social System	Structure	Smelling	Social System
Culture	Code	Tasting	Culture

Figure 2. Berlo’s SMCR Model of Communication. Adapted from *The Process of Communication*, by D.K. Berlo, 1960, New York, NY:Holt, Rinehart and Winston.

Purpose and Objectives

The purpose of this study was to examine the use of Twitter by agricultural communicators and use this information to construct a mathematical model to predict perceived efficacy of Twitter to send and receive messages.

The following objectives guided this work:

- 1) Collect Twitter usage statistics and perceived efficacy of Twitter to send and receive messages from agricultural communicators who used Twitter to both send and receive messages.
- 2) Predict the perceived efficacy of agricultural communication Twitter users to send messages via Twitter as indicated by age, time spent using Twitter, tweets sent and received, following and follower relationships, and use of auxiliary means.
- 3) Predict the perceived efficacy of agricultural communications Twitter users to receive messages via Twitter as indicated by age, time spent using Twitter, tweets sent and received, following and follower relationships, and use of auxiliary means.

This research fits within the National Research Agenda Research Priority Area 4: “Build competitive societal knowledge and intellectual capabilities within agricultural communications” (American Association for Agricultural Education, 2007, p. 5).

Methods and Procedures

To address the objectives of this research, researchers used a correlation research design (Fraenkel & Wallen, 2006) with an online instrument. Data was analyzed using descriptive and correlational/regression methods. As stated by Frankel and Wallen (2006), “Correlational research is carried out for one of two purposes—either to help explain important human behaviors or predict likely outcomes” (p. 336). This research looked to explain how communication occurs within Twitter and predict factors that led to the perception of effective Twitter communications.

The population studied in this research consisted of agricultural communicators who were members of at least one of five professional agricultural communications organizations. The five agricultural communications organizations and the accessible population for each included the following:

- Association for Communication Excellence in Agriculture, Natural Resources, and Life and Human Sciences; 507 accessible members
- National Agri-Marketing Association; 1,491 accessible members
- Livestock Publications Council; 196 accessible members
- American Agricultural Editors’ Association; 386 accessible members
- National Association of Farm Broadcasting; 427 accessible members

Many participants are on the contact list for more than one organization. The total accessible population consisted of 2,765 individuals.

The researcher-designed instrument was administered via Survey Monkey. The instrument consisted of both closed-ended and open-ended questions. A panel of agricultural communications faculty reviewed the instrument for face and content validity. A panel of

graduate student researchers reviewed the instrument for face validity. Both groups independently determined the instrument to be a valid measure of the objectives. The instrument was pilot tested on 22 agricultural education and communications graduate students. The data from the pilot was coded into SPSS for Windows Version 16. A Cronbach's alpha was calculated for the multiple-choice items for the sending efficacy regression model and the receiving efficacy regression model. Due to a low incidence of Twitter usage among graduate students in the pilot, low values for Cronbach's alpha were returned. As such, additional post hoc evaluation of Cronbach's alpha was completed. Post hoc reliability tests were completed on the 632 instruments returned by agricultural communicators. For the eight items in the sending construct the Cronbach's alpha based on standardized items was .67. The Cronbach's alpha based on standardized items for the eight questions in the receiving construct was .63. According to Nunnally (1978), Cronbach's alphas of .5 to .6 are acceptable for researcher-designed instruments in the early stages of development. The instrument included 39 items on 16 pages, or windows, within the Web interface. This work was part of a larger study. Items were included in the instrument that were not included in this research piece. The survey was tailored to each respondent based on responses to certain items. This skipping, or branching, allowed respondents to only respond to questions that pertained to them (Alreck & Settle, 2004). For example, on the item that asked about familiarity with Twitter, if a respondent marked "Have not heard of Twitter," he or she was automatically redirected to the demographic section near the end of the instrument. In this manner, non-Twitter users were not presented with the Twitter-specific questions that did not apply to them. A modified Dillman (2000) approach was used to collect data and consisted of four email contacts as shown in Table 1.

Table 1

Instrumentation Schedule

Contact	Day	Weekday	Item
1	1	Monday	Pre-notice letter
2	3	Wednesday	Link to questionnaire
3	5	Friday	Thank you and link
4	10	Wednesday	Thank you and link

Brashears, Bullock, and Akers (2003) and Shinn, Baker, and Briers (2007) studied response rate based on day of receipt of an emailed instrument. In both studies, the highest response rate was from respondents who received emailed instruments on a Wednesday. While the results were not statistically significant in either study, the results of both studies may imply practical significance. The link to the emailed instrument in this study was sent on a Wednesday. A total of 2,765 emails were sent in the first contact. Of those, 46 people asked to have their name removed from the contact list and 189 emails were returned as undeliverable. The total number of valid, usable email addresses for agricultural communicators was 2530. After four contacts, 632 completed instruments were returned for a response rate of 24.98%. Researchers employed Lindner, Murphy, and Briers (2001) methods one and two to check for non-response error to ensure external validity in this population. To analyze responses using method one, as recommended by Lindner, Murphy, and Briers (2001), researchers compared early to late respondents based on Twitter use and non-use using *Chi-square* and *t-test* analysis. With both tests, early and late respondents were found to be statistically similar.

Researchers also used regression analysis to determine if early respondents differed from late respondents as suggested in method two by Lindner, Murphy, and Briers (2001). Days from initial email to completion of the instrument was used as the independent variable and age was used as the dependent variable. Age was chosen as the item was not programmatically skipped for any respondents (all respondents had the option to answer this item), and was a continuous variable. Regression analysis revealed that days to respond did not significantly explain age of agricultural communicators, $F(1, 563) = .166, p = 0.684$. The R^2 for the model was .000 and adjusted R^2 was -.001. As such, researchers concluded that early and late respondents were not statistically different.

Completed responses were downloaded into Excel and converted to SPSS Version 16. Not all instruments were completed in their entirety. Cases with missing values were omitted from analysis. Throughout the remainder of this work, “n” refers to the total number of *usable* cases within the population. All regression analysis was completed using the forced entry method.

Findings

Objective 1

Objective 1 was to collect Twitter usage statistics and perceived efficacy of Twitter to send and receive messages from agricultural communicators who used Twitter to both send and receive messages. Of the agricultural communicators who responded, 238 marked that they used Twitter to both send and receive messages. Specifically, researchers asked respondents how many tweets he or she sent and received per day, the number of other users he or she was following (# following), the number of users that were following the respondent (# followers), time spent per day using Twitter, age of the respondent, and use of auxiliary means to access information. Researchers also asked respondents to rate their perceived efficacy of Twitter to send communications and their perceived efficacy of Twitter to receive communications. Respondents answered the two efficacy questions on a scale from 1 to 100 with 0 designating “not at all effective” and 100 designating “extremely effective”.

The mean number of tweets sent per day was 2.78 with a range of 0 to 25 and a standard deviation of 3.21, this figure was appreciably less than the 177.49 tweets received per day on average. Tweets received ranged from 0 to 3,000 with a standard deviation of 395.13.

Agricultural communicators were following a mean of 248.05 other Twitter users. The minimum number of following relationships was 4, the maximum was 2,300, the standard deviation was 359.60. On average, agricultural communicators had 309.78 followers with a minimum of 4 followers and a maximum of 2,300 followers, and a standard deviation of 419.05. The amount of time spent using Twitter per day ranged from 0 minutes to 180 minutes (3 hours) with a mean of 34.77 minutes and a standard deviation of 36.35. The mean age for agricultural communicators who used Twitter was 41.95, with a range from 21 to 76 and a standard deviation of 11.79.

As shown in Table 2, when asked to mark their level of perceived efficacy for Twitter in sending and receiving messages, Agricultural communicators marked responses that ranged from 0 to 100 with a mean of 52 for sending and 54 for receiving.

Table 2

Descriptive Statistics for Components of Agricultural Communicators' Twitter Use

Usage Component	n	Mean	Minimum	Maximum	SD	Median
Tweets sent	207	2.78	0	25	3.21	2.00
Tweets received	194	177.49	0	3000	395.13	50.00
# Followers	202	309.78	4	2300	419.05	123.00
# Following	202	248.05	4	2300	359.60	100.00
Minutes per day	202	34.77	0	180	36.35	30.00
Age	180	41.95	21	76	11.79	43.00
Sending	219	52.09	0	100	26.25	50.00
Receiving	212	54.27	0	100	27.76	57.50

Agricultural communicators were also asked about their use of auxiliary means to access tweets of interest to them. Six specific questions were asked to address this objective. Responses were recorded on the following scale: 0 = have not heard of this feature, 1 = never, 2 = rarely, 3 = sometimes, and 4 = frequently. As shown in Table 3, the items with the highest mean were "I use the Twitter Web site to search for tweets of interest to me" and "I include hashtags within the tweets I send" with a mean of 2.69. The item with the lowest mean was "I use a search engine to find hashtags of interest to me" with a mean of 1.55. The grand mean or mean of the means for the set of six items was 2.25, a value which fell between the rarely and sometimes descriptors.

Table 3

Use of Auxiliary Means to Communicate within Twitter by Agricultural Communicators

Item	Mean	Median	Mode	Min - Max	SD
I include hashtags within the tweets I send. (<i>n</i> = 271)	2.69	3	3	0-4	1.11
I use the Twitter Web site to search for tweets of interest to me. (<i>n</i> = 271)	2.69	3	3	1-4	0.96
I use the Twitter homepage to see what people are tweeting about in general. (<i>n</i> = 271)	2.44	2	2	0-4	0.98
I use the Twitter Website to search for hashtags of interest to me. (<i>n</i> = 268)	2.37	2	3	0-4	1.08
I use a search engine to find tweets of interest to me. (<i>n</i> = 271)	1.73	2	1	0-4	0.95
I use a search engine to find hashtags of interest to me. (<i>n</i> = 272)	1.55	1	1	0-4	0.93
Grand Mean	2.25				

Note. Responses recorded on the following scale: 0 = Have not heard of this feature, 1 = never, 2 = rarely, 3 = sometimes, and 4 = frequently.

Preliminary data analyses were conducted to find and remove computer generated-errors, remove outliers, and ensure that all data met the assumptions for the proposed tests. Researchers also checked for conformity to the assumptions for regression. All variables were within acceptable ranges as defined by Abrams (2007) and Field (2001).

Objective 2

Objective 2 was to predict the perceived efficacy by agricultural communicators Twitter users to send messages via Twitter as indicated by age, time spent using Twitter, tweets sent and received, following and follower relationships, and use of auxiliary means.

When combined, age, total time spent using Twitter, number of Tweets sent, number of Tweets received, number of followers, number following, and use of auxiliary means yielded a statistically significant model for predicting efficacy of the use of Twitter to send messages, see Table 4 for a summary of the regression analysis.

Table 4

Summary of the Regression Model to Predict Efficacy of Twitter to Send Messages (n = 159)

<i>R</i>	<i>R</i> ²	<i>Adjusted R</i> ²	<i>df</i>	<i>F</i>	<i>p</i>
.502	.252	.215	7, 141	6.783	< .000

Of the predictor variables, number of followers and use of auxiliary means had statistically significant relationships with perceived efficacy of Twitter to send messages. See Table 5 for predictor variable beta weights, correlation coefficients, and squared structure coefficients. Beta weights express the contribution of the predictor variable to the overall regression model, correlation coefficients determine the independent relationship of the predictor variable with the dependent variable, and the squared structure coefficient is the unique amount of explained variance of that predictor variable to the total effect size.

Of the predictor variables, the variable that seemed to be the most statistically influential predictor variable was the use of auxiliary means ($r = .37$, $r_s = .781$, $r_s^2 = .610$, and $\beta = .267$). The second most influential predictor variable was number of followers with the highest beta weight ($\beta = .272$) and a moderately high squared structured coefficient ($r_s^2 = .317$). Age ($\beta = -.145$) had a slightly negative relationship with perceived efficacy of sending messages on Twitter. While time ($\beta = .125$) and tweets sent ($\beta = .132$) contributed a small amount to the regression model, both predictor variables explained a high amount of variance of the total effect size of the model and both are moderately correlated with the perceived efficacy of Twitter to send messages.

Of the predictor variables in the regression model for perceived efficacy of sending messages with Twitter, the most influential predictor variables are use of auxiliary means, number of followers, time spent on Twitter, and tweets sent. The higher the perceived efficacy reported the more likely auxiliary means are used, the number of followers are high, the more time spent on Twitter, and more tweets sent.

Table 5

Predictor Variable Estimates for Perceived Efficacy of Sending Messages with Twitter (n = 159)

	<i>r</i>	<i>r_s</i>	<i>r_s²</i>	β
# of followers	0.22*	.563*	0.317	.272*
Auxiliary	0.37*	.781*	0.610	.267*
# following	0.19*	.401*	0.161	-.216
Age	-0.22*	-.414*	0.171	-.145
Time	0.30*	.682*	0.465	.125
Tweets sent	0.31*	.672*	0.452	.132
Tweets received	0.04	.107	0.011	-.069

Note. *r* = correlation coefficient, *r_s* = structure coefficient, *r_s²* = squared structure coefficient, β = beta weight.

**p* < .05.

Objective 3

To predict the perceived efficacy of Twitter to receive messages, researchers regressed age, total time spent using Twitter, number of tweets sent and received in a day, number of followers, number following, and use of auxiliary means on the perceived efficacy of Twitter to receive messages by agricultural communicators who used Twitter.

The regression model was statistically significant and explained 22% of the variance. See Table 6 for the model summary statistics.

Table 6

Summary of the Regression Model to Predict Efficacy of Twitter to Receive Messages

<i>R</i>	<i>R²</i>	Adjusted <i>R²</i>	<i>df</i>	<i>F</i>	<i>p</i>
.503	.253	.216	7, 141	6.838	< .000

Of the predictor variables, age, time spent per day using Twitter, number following, and use of auxiliary means made statistically significant contributions to the overall model. See Table 74 for the predictor variable beta weights, correlation coefficients, and squared structure coefficients.

When regressed onto perceived efficacy of receiving messages with Twitter, similar to Objective 2 results, the most statistically influential predictor variable was the use of auxiliary means ($\beta = .275$, $r_s^2 = .446$). The use of auxiliary means explained nearly half of the overall explained variance in the model. The predictor variables age and time were also strong variables in the model, with age showing a negative relationship with perceived efficacy of receiving messages with Twitter. The number following had the most statistical influence concerning the overall model ($\beta = -.302$); however, this variable did not contribute any unique explained variance to the overall effect size.

Again, the use of auxiliary means was the most statistically influential variable in the model followed by number following, age, and time spent on Twitter. Auxiliary means and time showed that the more these variables were used the higher the perceived efficacy of receiving messages with Twitter, while the higher the number following and the higher the age, the less the perceived efficacy of receiving messages with Twitter.

Table 7

Regression Explaining Perceived Efficacy of Receiving Messages with Twitter (n = 158)

Predictor	<i>r</i>	<i>r_s</i>	<i>r_s²</i>	β
# following	0.02	.061	0.004	-.302*
Auxiliary	0.37*	.668*	0.446	.275*
Age	-0.29*	-.611*	0.373	-.265*
Time	0.37*	.652*	0.425	.240*
# of followers	0.00	.157	0.025	.170
Tweets received	-0.05	-.101	0.010	-.059
Tweets sent	0.17*	.343*	0.118	-.038

Note. *r* = correlation coefficient, *r_s* = structure coefficient, *r_s²* = squared structure coefficient, β = beta weight.

**p* < .05.

Conclusions

Conclusions and Discussion for Objective 1

Based on the results of this work, researchers drew the following conclusions regarding Objective 1. Agricultural communicators who used Twitter on average sent just a few tweets per day. Agricultural communicators who used Twitter on average received many more tweets than they sent in a day. Generally, agricultural communicators who used Twitter were following a higher number of Twitter accounts than were following them.

These results are somewhat counterintuitive, as agricultural communicators are actually *receiving* more tweets than they are *sending* and following more accounts than are following them. These facts underscore the flow of Twitter communication as two-way, with the communicator receiving as much (or in this case, more) information than they send.

Conclusions and Discussion for Objective 2

Using a regression model, researchers were able to draw several conclusions regarding the effects of seven predictor variables in predicting the efficacy of Twitter to send messages. The seven variables in combination yielded a statistically significant model that was able to predict 22% of the variance of perceived efficacy of Twitter to send messages. Two variables yielded statistically significant contributions within the model on their own. These two variables were number of followers and use of auxiliary means. The variable that predicted the most unique variance within the model was use of auxiliary means. This variable predicted 61% of the unique variance as shown by the squared structure coefficient.

While in combination, all seven variables produced a statistically significant model, the variables with the most impact were number of followers and use of auxiliary means. This may imply that within effective Twitter use more is not necessarily better. Instead of simply tweeting more,

practitioners may see better results by securing more followers and by using hashtags or key words to make their messages more accessible.

Conclusions and Discussion for Objective 3

The seven variables studied concerning Twitter efficacy in receiving messages yielded a statistically significant regression model. Researchers drew the following conclusions. The seven variables in combination yielded a statistically significant model that was able to predict 22% of the variance of perceived efficacy of Twitter to receive messages. Number following, auxiliary means, time, and age made statistically significant contributions to the model on their own. The number of accounts a user was following was negatively related to their perceived efficacy of Twitter in receiving messages. The variable that predicted the most unique variance within the model was use of auxiliary means. This variable predicted 45% of the unique variance as shown by the squared structure coefficient. Age was negatively correlated to perceived efficacy.

Efficacy of using Twitter to receive messages can be predicted using the seven variables studied. Number of people a user was following was negatively related to perceived efficacy, this could be due to an “information overload” in which Twitter users who follow too many other accounts are over-burdened with near-constant tweets and are not able to glean value from the exchange.

Implications

In both regression models, the use of auxiliary means made the largest unique contribution to the model. As such, traditional communication models may not adequately describe the flow of communication within Twitter.

Based on the findings of this study, researchers proposed a modified communication model to illustrate communications within Twitter. As shown in Figure 3, this new model incorporates the simplistic, linear nature of the Shannon Weaver model with the addition of an auxiliary group as indicated by this research.

The model consists of a sender and receiver communicating with messages. In contrast to the Berlo (1960) model, the channel for the message, tweets, is a constant and as such it is removed from the model. Similar to the Berlo model, and as shown by this research, the messages go from the sender to the receiver and from the receiver to the sender. Both participants serve in both functions. This relationship is highlighted in this model “subscript Receiver” and “subscript Sender” illustrated within the Sender and Receiver constructs, respectively.

The use of auxiliary means is an important factor in predicting the success of Twitter communications. Given the importance of the use of auxiliary means in predicting the perceived efficacy of Twitter, researchers included an auxiliary receiver in the model. This auxiliary receiver is a consumer of the information produced by the senders and receivers without interacting with the sender or receiver directly. Search engines, hashtags, and other indexing or search applications make the existence of this auxiliary receiver possible.

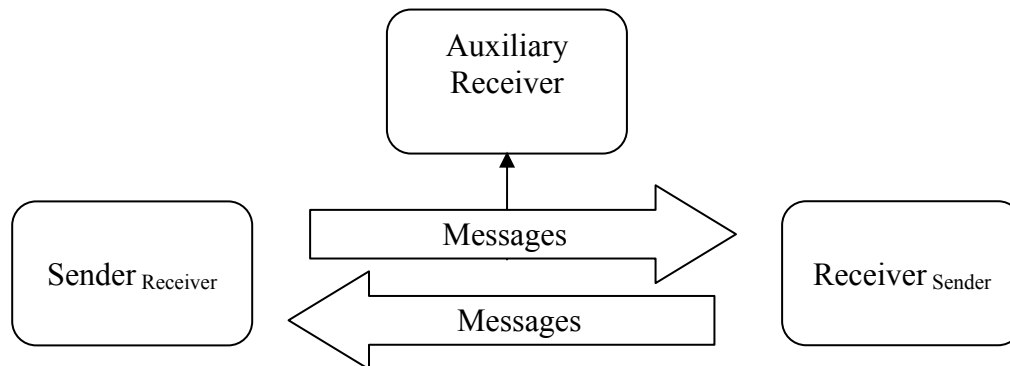

Figure 3. Shultz Twitter Communication Model. Proposed model for communication within Twitter.

References

- About Twitter: About us. (2009). Retrieved June 25, 2009, from <http://Twitter.com/about#about>
- Abrams, D. R. (2007). Introduction to Regression. Retrieved January 13, 2010, from http://dss.princeton.edu/online_help/analysis/regression_intro.htm
- Agchat. (2009, November 7). Agchat. Retrieved November 7, 2009, from <http://Twitter.com/Agchat>
- Allen, K., **Abrams, K. M.**, Meyers, C. A., & Shultz, A. (in press, 2010). A little birdie told me about agriculture: Best practices and future uses of Twitter in agricultural communications. *Journal of Applied Communications*.
- Alreck, P.L. & Settle, R.B. (2004). *Survey research handbook* (3rd edition). New York, NY: McGraw-Hill.
- American Association for Agricultural Education. (2007). *National Research Agenda Agricultural Education and Communication: Research Priority Area and Initiatives*. Retrieved March 11, 2010, from http://aaaeonline.org/files/researchagenda_longlores.pdf
- Baran, S. J., & Davis, K.D. (2006). *Mass communications theory: Foundations, ferment, and future*. Boston, MA: Wadsworth Cengage Learning.
- Berlo, D.K. (1960) *The process of communication*. New York, NY: Holt, Rinehart and Winston.
- Boone, K., Meisinbach, T., & Tucker, M. (2000). *Agricultural communications: Changes and challenges*. Ames, IA: Iowa State University Press.

- Brashears, M.T., Bullock, S., & Akers, C. (2003). A test of a bimodal survey model on the cooperative communicators association: A case study. Paper presented at the National Agricultural Education Research Conference, December 9-11, Orlando, FL.
- Dillman, D. A. (2000). *Mail and Internet surveys: The tailored design method*. 2nd ed. New York, NY: John Wiley & Sons.
- Field, A. (2001). *Discovering Statistics Using SPSS*. London: Sage Publications.
- Fraenkel, J.R., & Wallen, N.E. (2006). *How to Design and Evaluate Research in Education* (6th edition). Boston: McGraw Hill.
- Gronbeck, B.E., McKerrow, R.E., Ehninger, D., Monroe, A. H. (1994). *Principles and types of communication* (12 ed.). New York, NY: Harper Collins College Publishers.
- Lindner, J. R, Murphy, T. H., & Briers, G. E. (2001). Handling non-response in social science research. *Journal of Agricultural Education*, 42(4), 43-53.
- McFedries, P. (2009). *Titter: Tips, tricks, and tweets*. Indianapolis, IN: Wiley Publishing, Inc.
- Metts, S. (2004). Introduction to communication theory. In B. Baldwin, S.D. Perry, & M.A. Moffitt (Eds.), *Communication theories for everyday life* (pp. 3-19). Boston: Pearson.
- Mortensen, C.D. (1972). *Communication: the study of human interaction*. New York: McGraw-Hill.
- Nunnally, J. C. (1978). *Psychometric theory* (2nd ed.). New York: McGraw-Hill.
- Ohio Farm Bureau. (2009, November 2). *Ohio Farm Bureau*. Retrieved November 2, 2009, from <http://Twitter.com/Ohiofarmbureau>
- Ostapuk, P. (n.d.). The Marathon story. Retrieved from <http://www.lakepowell.net/marathon.html>
- Paul Revere Memorial Association (2008). The real story of Revere's ride. Retrieved from <http://www.paulreverehouse.org/ride/real.shtml>
- Pork Checkoff. (2009) Pork Checkoff Report. Retrieved November 7, 2009, from <http://www.pork.org/porkcheckoffreport/2009Fall/html/index.html>
- Shinn, G. C, Baker, M., & Briers, G. E. (2007). Response patterns: Effect of day of receipt of an e-mailed survey instrument on response rate, response time, and response quality. *Journal of Extension* [On-line], 45(2) Article 2RIB4. Available at: <http://www.joe.org/joe/2007april/rb4.php>
- Weiner, N. (1967). *The human use of human beings*. New York: Avon.

Agricultural Communications Training Needs Among Oklahoma Agricultural Educators

*Ashley Stockamp, Shelly Peper Sitton, and Denise George
Oklahoma State University*

Abstract

This study was designed to determine the professional development and curriculum needs of Oklahoma secondary agricultural education teachers as related to teaching agricultural communications. A purposeful sample of 19 Oklahoma secondary agricultural education teachers was used as a focus group based on their interest in teaching agricultural communications courses. This group provided information related to Hanson's (2007) study showing Oklahoma agricultural teachers scored less than 60% on an agricultural communications knowledge-based test. Additionally, information was collected to determine solutions for this lack of agricultural communications knowledge. Based on the responses, curriculum should be developed to showcase the broad range of agricultural communications competencies. Additionally, universities should develop agricultural communications courses designed specifically for pre-service teachers, and a resource database should be created to give agricultural educators easy access to agricultural communications information.

Introduction

Agricultural education has played a major role in feeding America since the birth of the United States by “teaching tomorrow’s farmers and ranchers how to feed the world” (Grant, Field, Green, & Rollins, 2000, p. 1684). When the Smith-Hughes Act of 1917 established vocational agriculture programs, the federal government defined its role within secondary agricultural education programs and developed the first nationwide system of support (True, 1929). Also known as the National Vocational Act, the Smith-Hughes Act provided \$500,000 in 1918 to assist states in paying teachers, supervisors, and directors of agricultural subjects (Kliever, 1965).

In the beginning, vocational agriculture courses were designed to teach farm boys about new practices in animal husbandry and new techniques to improve their crop yields (Phipps & Osborne, 1988). As the American society changed, so did the face of agricultural education. People moving away from family farms and rural areas created a lower level of agricultural literacy (Graves, 2005). This paradigm shift as well as the need to inform agricultural producers led to the development of agricultural communications programs (Boone, Meisenback, & Tucker, 2000).

Agricultural journalism/communications programs were developed to produce “scholars who utilize the fundamentals of communications and agriculture to create graduates who are instructed to distribute agricultural reports to agriculture and non-agricultural groups” (Ciuffetelli, 2002, p. 10). The first agricultural communication course titled “The Agricultural Press” was offered at Iowa State University (ISU) in 1905, and by 1930, ISU offered a bachelor’s degree in agricultural journalism (Marvin, 1946). By 1990, agricultural communication programs were offered at 30 universities in the United States (Doefert & Cepica,

1991). Since the discipline's beginning, agricultural communications quickly gained acceptance within the agricultural industry (Tucker, Whaley, & Cano, 2003). However, when Hanson (2007) studied Oklahoma secondary agricultural education teachers she found their perceived knowledge of communication competencies to be higher than the scores they earned on a general knowledge test. "Based on knowledge test scores, Oklahoma agricultural education teachers did not have adequate knowledge to teach agricultural communications courses" (Hanson, 2007, p. 93). The National Research Agenda for Agricultural Education and Communications listed the need to "assess the professional and continuing education needs of agricultural educators" as a priority research initiative (Osborne, 2007, p 20). This study recognized the need for additional professional development in agricultural communications for secondary agricultural educators as well as an organized curriculum for secondary agricultural education students.

Problem

An thorough literature review identified a lack of teacher-expressed, needs-based research about agricultural communications curriculum at the secondary agricultural education level. Previous research showed teachers' knowledge test scores to be below passing (<60%) in many areas of agricultural communications; however, little research had explored the reasons behind these scores. This study sought to gain teacher reactions and assess needs to improve overall teacher competence in agricultural communications.

Purpose/Objectives

The purpose of this study was to determine the professional development and curriculum needs of Oklahoma secondary agricultural education teachers as related to teaching agricultural communications. The specific objectives of this study were to:

1. Identify selected personal and professional characteristics of Oklahoma secondary agricultural education teachers who could impact students learning agricultural communications competencies;
2. Identify Oklahoma secondary agricultural education teachers' responses to Hanson's (2007) research findings; and
3. Identify resources universities can offer to help Oklahoma secondary agricultural education teachers to teach agricultural communications.

Conceptual Framework

A conceptual framework was developed as a basis for this study. The method was presented by Dunkin and Biddle (1974) and is a model of variables in teaching and learning. According to Dunkin and Biddle (1974), four variables are present in the teaching and learning process: presage variables, context variables, process variables, and product variables. The variables start in the broad context of the classroom and filter into the classroom to produce the product variables as demonstrated in Figure 1.

Presage variables are the main focus in the study of teaching. Dunkin and Biddle (1974) defined these as the "characteristics of teachers that may be examined for their effects on the teaching process" (p. 39). Presage variables include teacher formative experiences and

encompass every experience the teacher has before entering the classroom (Dunkin & Biddle, 1974). These experiences include everything leading up to the teacher's professional preparation (Dunkin & Biddle, 1974).

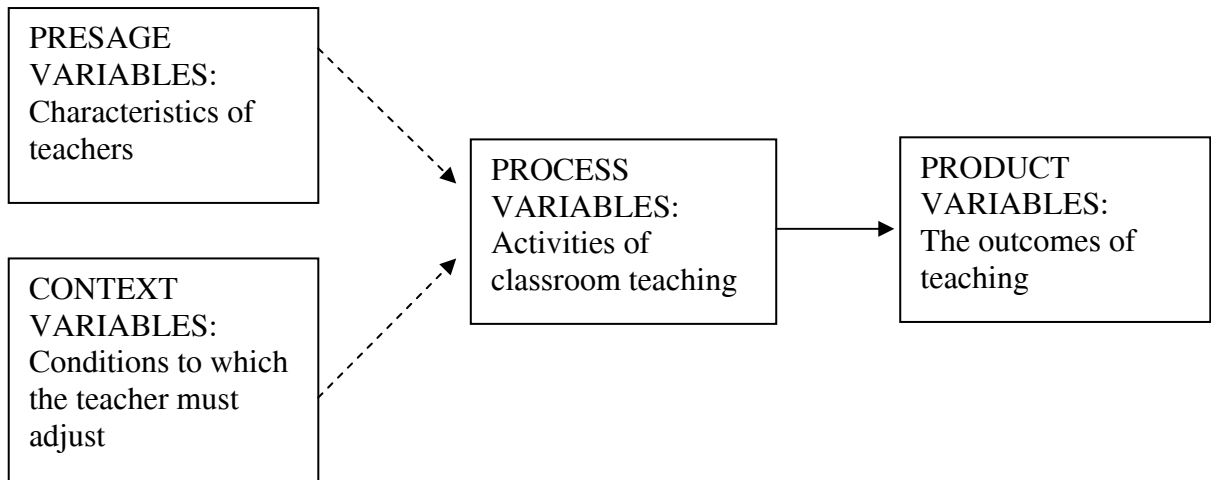

Figure 1. A model of the study of teaching developed by Dunkin and Biddle (1974).

Teacher properties include the measurable personality characteristics a teacher brings into the classroom (Dunkin & Biddle, 1974). These characteristics determine the effectiveness of other experiences because teaching largely involves personal relationships that require certain personality traits (Dunkin & Biddle, 1974). By changing the teacher preparation experience, the classroom is changed and the effects on the students will change as a result of changes in the teacher's behaviors (Dunkin & Biddle, 1974).

Methodology

Based on the objectives of the study and previous research in the field, the researcher conducted a case study. A semi-structured focus group interview method was used to collect data from Oklahoma secondary agricultural education teachers, i.e., a purposeful sample.

Creswell (2007) described case study research as “the study of an issue explored through one or more cases within a bounded system” (p. 73), or one that is bounded by place and time. A focus group was conducted with a purposeful sample of agricultural education teachers to investigate the issue of agricultural communications knowledge among Oklahoma secondary agricultural education teachers.

Question development is important when facilitating discussion within a focus group because the data comes from responses to the prompts provided by the facilitator (Glesne, 2006). In this particular study, more than one section of the focus group was being conducted simultaneously; therefore, the researcher was not the facilitator of both sessions. With multiple facilitators, a protocol must be developed and followed to ensure consistency of discussion topics and prevent leading from the facilitators (Glesne, 2006).

The protocol for this study was created by the researcher to promote rich and full discussion among participants while still allowing ease of transcription after completion of the interviews. Directions had to be given to the participants to ensure the group would run efficiently and to maintain structure in the focus group (Glesne, 2006).

The researchers pilot tested the study's interview protocol in Ramsey, Illinois. This was conducted to test the process of the protocol, not to collect data. The pilot was done using a population close to the actual population of the study to ensure understanding of the protocol and practice for the researcher as suggested by Glesne (2006). The pilot with nine participants required 35 minutes to complete. A 15-minute follow up was then completed with the researcher to discuss any issues the participants had with the protocol.

Once the issue and case have been established, data must be collected to address the issue. Creswell (2007) presented a data collection circle (see Figure 2) to visualize the necessary steps for acquiring accurate data.

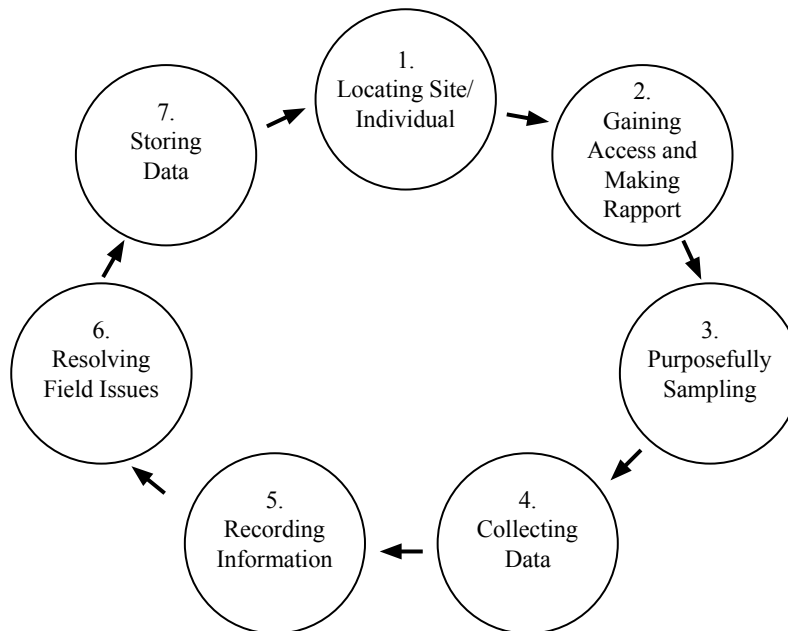

Figure 2. Qualitative Data Collection Activities. Adapted from “Data Collection” by J. W. Creswell, 2007, *Qualitative inquiry and research method: Choosing among five approaches*, p. 118. Copyright 2007 by Sage Publications.

The data collection circle, or process, starts by selecting an accessible site or individual who is willing to share information related to the case (Creswell, 2007). Part of gaining access includes approval from the Institutional Review Board (IRB) and giving participants an option to leave the study at any point (Creswell, 2007).

After IRB approval, the Oklahoma State University, Stillwater campus, was chosen because it was centrally located, and the researcher worked in cooperation with the Oklahoma

Department of Career and Technology Education, or ODCTE, which is headquartered in Stillwater, OK. ODCTE offered teacher in-service education to develop new curriculum in agricultural communications at Oklahoma State University (K. Murray, personal communication, October 11, 2010).

The population in qualitative research is purposeful, giving the researcher the ability to choose certain criteria the participants must meet before taking part in the data collection exercise (Glesne, 2006). This population must be narrowed down because the research situation is “too vast to interview everyone” (Glesne, 2006, p. 34).

The population selected for this study was Oklahoma secondary agricultural education teachers who teach or want to teach agricultural communications. Random sampling was not appropriate in this study because a certain population was being targeted. Therefore, the researcher chose homogeneous purposive sampling (Glesne, 2006) to determine the sample used in the study.

The selected teachers showed an interest in teaching agricultural communications through their participation in a teacher professional development workshop at Oklahoma State University. During the workshop, these teachers were asked to take part in the study. All 19 of the in-service participants (100%) agreed to participate in the study and thus formed the purposeful sample (Glesne, 2006). At least one representative from each of the five districts of Oklahoma FFA participated in the study.

This study used a focus group interview for data collection because a larger sample could be interviewed, and it allowed the members to reflect on other members’ thoughts and differing opinions (Marshall & Rossman, 2006). The focus group was divided into two sessions – one with 10 participants and the other with nine participants. The focus group followed a specific protocol, and facilitators were trained to conduct the interview sessions to ensure consistency between the simultaneous sessions.

During data collection, multiple methods can be used to record the data, including voice recording, video recording, and researcher note taking (Creswell, 2007). Data collected in this study was recorded on a voice recorder as well as video recorder. The voice recorder was placed in the center of each table, and the video recorder was placed at the end of the tables to capture all participants’ contributions.

The final stage in the data collection circle is the storing of data collected. Creswell (2007) noted the data should be filed carefully and stored in one consistent location throughout the study to ensure all data is used in the research. The researcher stored all data in a locking file cabinet to protect the rights of participants. All voice recordings also were stored in digital format on a password-protected computer.

The group began by providing information about selected personal and professional characteristics as a method for establishing a comfort zone for talking in front of each other. By doing this, each person had the opportunity to speak and release the initial anxieties he or she may have had communicating with his or her peers (Glesne, 2006).

The information about selected personal and professional characteristics was followed by questions designed to encourage free-flowing discussion among all members of the focus group. The main questions were made to be simple to encourage members to express their thoughts and opinions through a supportive environment (Marshall & Rossman, 2006).

To achieve consistency in data collection, a protocol was developed, approved by the university’s Institutional Review Board, and followed by the facilitator in each focus group interview session. The lead researcher conducted focus group session one and a fellow graduate student was the facilitator for focus group session two.

During the focus group interview sessions, the facilitator and the researcher followed the protocol and used only the questions included in the protocol to direct participants’ discussion. Based on review of video from each focus group session, protocol was followed to obtain accurate data, i.e., the facilitators did not become involved in the discussion, as was suggested by Stewart, Shamdasani and Rook (2007). With facilitators guiding rather than leading the group’s discussion, the discussions could be open to new topics.

Following the focus group interview sessions, the researcher transcribed the data from both the voice and video recordings, verifying the consistency between the transcripts. Additionally, the transcript was sent to participants for the opportunity to correct any errors. No corrections were suggested or made through this member check. Although researcher bias can never be removed fully, the awareness of personal biases was noted and checked with peer reviewers. The researcher analyzed the data to group statements into emergent themes.

Findings

The focus group participants included 19 teachers who attended an ODCTE-sponsored in-service workshop. Five female participants (26.32%) and 14 male participants (73.68%) agreed to participate in this study. Teacher participants in the focus group represented each of the state’s five administrative districts (see Table 1).

Table 1

Distribution of focus group participants among the Oklahoma FFA Districts

District	Participants ^a	%
Northeast	5	26.32
Northwest	6	31.58
Central	4	21.05
Southeast	3	15.79
Southwest	1	5.26

Note. ^an=19

Based on the responses of the focus group, 13 participants (68.42%) were in their first five years of teaching. Eleven participants (57.89%) had between one and five years of experience teaching agricultural communications at the secondary level. Seven (36.84%) had not taught agricultural communications at the secondary level, and one (5.26%) late arrival did not

respond. In addition to teaching experience, participants had varied levels of academic preparation in agricultural communications (see Table 2).

Table 2

Teachers' formal academic preparation in agricultural communications

Completed Courses	Participants ^a	%
None	4	21.06
One introductory course	11	57.90
Two courses	1	5.26
Three courses	1	5.26
Several courses	1	5.26
No response	1	5.26

Note. ^an=19

To identify Oklahoma secondary agricultural education teachers' perceptions of Hanson's (2007) research among their peers, the participants discussed that study's results. The emergent themes were categorized into three sections: reasons for teacher knowledge level, impact on student learning, and perceived importance compared to test scores (see Table 3).

In regard to the scope of agricultural communications, participants stated many teachers view agricultural communications as public speaking and leadership and students do not learn the other aspects of agricultural communications. One participant said:

A lot of ag teachers view ag communications as public speaking, and since a lot of [teachers] have students who are competitive at speech competitions they think that's ag communications. And they don't realize the editing and AP style and I think that's the misinterpretation there of what ag communications is.

One participant noted teachers feel as though they are experienced in agricultural communications because they edit student work, but those teachers may not have the correct answers on a knowledge-based test.

In reference to impact on student learning, participants mentioned the teachers' ability to pass knowledge along to the students was impaired when they did not know the subject area well. In most cases, the teachers noted they learned agricultural communications along with their students. According to participants, agricultural teachers are confident in their abilities but they may not realize where they need to improve their knowledge level until those skills are tested.

Table 3

Emergent themes from teachers' responses to previous research

Category	Emergent Themes
Reasons for teacher-recorded knowledge level	Lack of available technology and study materials Misunderstanding of the full scope of agricultural communications Teachers' inaccurate perception of personal knowledge level
Impact on student learning	Teachers need knowledge to pass knowledge tests Learn cooperatively with the students Teachers should continue to be lifelong learners
Perceived importance compared to test scores	Teachers perceive agricultural communications as public speaking and leadership Teachers need to be lifelong learners Children have a variety of benefits from teacher with higher knowledge Agricultural teachers may be confident in their abilities until they are tested

The final focus group question addressed differences between perceived importance of agricultural communications areas and the knowledge test scores in those areas. The most common response revolved around the perceived scope of agricultural communications. Participants said teachers view public speaking and leadership as the two main areas. The participants noted most teachers focus on those areas and do not take time to learn other areas of agricultural communications in which they do not have experience. Participants indicated teachers should be life-long learners. One participant said:

You always need to kind of learn a little more each day. ... You need to refresh yourself and kind of gain more information on how things are done today compared to how they were five or 10 year ago. So you need to learn more to teach your students.

Another participant said:

I should be learning the information that I can take back to my students, not just some random facts and things that I'm not going to be able to use and high school students may not have the cognitive abilities to understand yet.

Additionally, participants mentioned the material being taught in agricultural communications is important across the curriculum because the skills are something students can use in the real world.

Participants identified resources universities can offer to help Oklahoma secondary agricultural education teachers teach agricultural communications effectively (see Table 4).

Table 4

Emergent themes regarding teachers' needs in agricultural communications

Category	Emergent Themes
Curriculum structure	Broadened scope of agricultural communications More appropriate material for the secondary level Include more related to the career development event Send field representatives to ensure proper instruction
Teaching resources	Develop a resource database List supplemental materials to prepare for contests Offer answers to supplemental materials
Teacher professional development	Continue to offer teacher in-service Develop courses to teach methods of teaching agricultural communications More promotion of courses in agricultural communications
Student resources	Develop a DVD with CDE instruction Offer a student training day for the agricultural communications CDE

Participants indicated improved curriculum would help them understand what they should be teaching their students and expressed concern about the limited topic areas addressed in the curriculum they were using from the Oklahoma Department of Career and Technology Education's Curriculum and Instructional Materials Center. Participants said the curriculum focuses on public speaking and leadership, but the teachers would benefit more from curriculum that covers all aspects of agricultural communications.

The participants indicated when new curriculum has been developed they also will need a resource list to supplement the material as well as in-service education, which they said should be at the district level to encourage more participation. This list would include study materials with the answers for teachers. The participants stated they have to know a variety of subjects and teach multiple classes in a semester and it is difficult to search for the resources needed.

Participants also mentioned a need for more appropriate courses at the collegiate level. The teachers said it would be beneficial to create an agricultural communications course for agricultural education teachers who want to teach agricultural communications. Participants mentioned the need for university faculty to encourage agricultural education students to take agricultural communications courses as their electives. Participants said they had difficulty getting enrolled in courses at the collegiate level because the agricultural communications

students received first priority for enrollment. One participant reported attempting to enroll in a course three times, but the class was full every time she tried to enroll.

Other suggestions from the focus group included having a representative teach the teachers to use the curriculum; develop materials to show teachers that agricultural communications is more than public speaking and leadership; and have collegiate agricultural education programs promote endorsements in speech and language arts so courses could be offered for dual credit.

Conclusions

The majority of the teachers in the study had five or fewer years of teaching experience, and all the teachers had taught agricultural communications either five years or less or not at all. Most participants had taken an introductory class in agricultural communications during their college career, which would have an impact on their effectiveness (Dunkin and Biddle, 1974) for teaching an agricultural communications course at the secondary level, i.e. a presage variable.

As participants discussed previous research findings related to agricultural education teachers' knowledge level in agricultural communications, major themes arose. Teachers have a lack of understanding regarding the broad scope of communications, which is similar to previous findings (Hanson, 2007). Many of the teachers perceived agricultural communications as public speaking and leadership and were not familiar with all of the competency areas in agricultural communications developed by Akers, Vaughn, and Lockaby (2001) on which Hanson's (2007) instrument was based.

The participants expressed concern for the broad range of topics an agricultural teacher is expected to learn. The teachers would benefit more from resources they could apply directly to the classroom. A need exists for an updated curriculum, which should include detailed instruction for implementation to assist with teaching agricultural communications more effectively. Additionally, the need for an agricultural communications resources or references list exists for Oklahoma secondary agricultural education teachers. By having a compiled list of resources for the teachers to access, they could spend more time focusing on the use of said resources. Teachers also would have access to materials for a broader range of communications topics, and they could expand the scope of the agricultural communications curriculum they teach. A need also exists for universities to provide targeted agricultural communications courses to agricultural education students.

Recommendations

As an Oklahoma-specific case study, caution should be taken in generalizing this data beyond this sample. However, in light of the conclusions, the researchers offer the following recommendations.

To improve Oklahoma secondary agricultural education teachers' knowledge and resources in agricultural communications, curriculum should be improved to include all of the core communications competencies including: "writing, computer/information technology, agricultural industry, communications history, professional development, research/information

gathering, ethics, public relations/advertising/marketing, leadership development, legislative issues, and communication skills” (Akers et al., 2001, p. 127) in a manner that can be used effectively by the teachers. The curriculum should include all areas (topics) of agricultural communications and a variety of teaching methods and resources.

An agricultural communications database should be developed to compile the resources for teachers. It should be made available to teachers, in print and online, as a way to find supplemental materials for agricultural communications. This database should be linked to the Oklahoma Department of Career and Technology Education website of agricultural education as well as the Oklahoma State University agricultural communications website.

In-service education focusing on agricultural communications should be offered more often. Based on teacher-expressed needs for a district-level training in agricultural communications, these professional development opportunities should include all areas of communications and should extend teachers’ knowledge beyond speech writing and leadership. In-service opportunities should be provided in specific areas of agricultural communications, including writing, editing, photography, broadcasting, and graphic design. Lesson plans and resources should be available in all of these areas, as well.

Post-secondary courses should be offered for pre-service teachers. These courses should include the development of agricultural communications lesson plans and materials for use in their secondary agricultural education classrooms.

Implications

Suggestions were given in this study for improving Oklahoma secondary agricultural education teachers’ knowledge in agricultural communications. While it may be difficult to make all of the changes, an attempt should be made to implement as many changes as possible into the current practices in Oklahoma, so as to improve the experience of students in secondary agricultural education.

Some teachers indicated they use materials from college-level courses, which may not be appropriate for secondary students. Agricultural communications competencies need to be sorted, and topics need to be chosen that are level appropriate for secondary agricultural education and agricultural communications (Akers et al., 2001).

Current agricultural communications courses at the secondary level need to broaden the subjects and include more of the previously determined agricultural communications competencies (Akers et al., 2001). Many secondary agricultural education programs are teaching public speaking-based agricultural communications with some leadership (K. Murray, personal communication, October 11, 2010). The scope of agricultural communications goes beyond public speaking and leadership, and students should know the options available in agricultural communications as well as what they should learn to be proficient regarding entry-level employment or an entrance into post-secondary study. Ramsey (2009) indicated those skills included computer skills, contacting local newspapers and radio stations, chapter publicity, news reporting, designing fliers, using information, and writing news releases.

The supervised agricultural experience component of the secondary agricultural education model held the most potential for facilitating students learning of entry-level technical skills in the career pathways Animal Science and Agricultural Communications. (Ramsey, 2009, p. 155)

By improving the resources available to the teachers and by increasing opportunities for training students in agricultural communications, the overall agricultural communications classroom experience will be improved. Dunkin and Biddle's (1974) model of the study of teaching shows the connections between positive teacher and student experience and positive outcome in the classroom.

The recommendations in this study can be used to improve the presage variables in the classroom, which will improve the product variables. While research was not conducted directly with the students, the teachers in this study offered some suggestions on improving the context and content variables. Workshops for students will help them improve their knowledge level in agricultural communications outside of the classroom.

By using the teacher suggestions and creating curriculum and materials for classroom use, the content variable will be improved. The teachers will have materials available to bring into the classroom and improve the agricultural communications classroom experience.

References

- Akers, C., Vaughn, P. R., Lockaby, J. D. (2001). High school agricultural communication competencies: A national Delphi study. *Journal of Southern Agricultural Education Research*, 51(1), 124-137.
- Boone, K. N., Meisenback, T., & Tucker, M. (2000). *Agricultural communications; Changes and challenges*. Iowa State University.
- Ciuffetelli, C. R. (2002). Writing and editing proficiencies in agricultural communications: Frequency of use and role in curriculum. Unpublished master's thesis, Oklahoma State University, Stillwater.
- Creswell, J. W. (2007). *Qualitative inquiry and research method: Choosing among five approaches* (2nd ed.). Thousand Oaks, CA: Sage Publications Inc.
- Doerfert, D. & Cepica, M. (1991). *The current status of agricultural journalism programs in the United States*. Center for Technology Transfer, Texas Tech University.
- Dunkin, M. J., & Biddle, B. J. (1974). *The study of teaching*. New York; Holt, Rinehart, and Winston, Inc.
- Glesne, C. (2006). *Becoming qualitative researchers: An introduction*. 3rd.ed. Boston, MA: Pearson Education, Inc. Allyn and Bacon.

- Grant, P. M., Field, T. G., Green, R. D. & Rollins, B. E. (2000). The importance of comprehensive agricultural education in land-grant institutions: A historical perspective. *Journal of Animal Science*, 78(6), 1684-1689.
- Graves, R. A. (2005). *Communicating in the agricultural industry*. Clifton Park, NY: Thompson, Delmar Learning.
- Hanson, S. J. M. (2007). Knowledge of and perceptions about agricultural communications competencies as perceived by Oklahoma agricultural education teachers. Unpublished master's thesis, Oklahoma State University, Stillwater.
- Kliever, D. E. (1965). *Vocational education act of 1963: A case study in legislation*. Washington, DC: American Vocational Association, Inc.
- Marshall, C., & Rossman, G. B. (2006). *Designing qualitative research* (4th ed.), Thousand Oaks, CA: Sage Publications Inc.
- Marvin, K. R. (1946). *Agricultural journalism in Iowa. A century of farming in Iowa 1846-1946*, Ames, IA: The Iowa State College Press.
- Osborne, E., (Ed.). (2007). *National research agenda, agricultural education and communication: Research priority areas and initiatives, 2007-2010*: American Association for Agricultural Education.
- Phipps, L. J., & Osborne, E. W. (1988). *Handbook on agricultural education in public schools, 5th.ed.* Danville, IL: The Interstate Printers & Publishers, Inc.
- Ramsey, J. W. (2009). *Identifying entry-level skills expected by agricultural industry experts and determining teachers' perceptions on whether they are being learned through students' participation in the supervised agricultural experience component of the secondary agricultural education program: A two-panel Delphi study*. Unpublished doctoral dissertation, Oklahoma State University, Stillwater.
- Stewart, D. W., Shamdasani, P.N., & Rook, D.W. (2007). *Focus groups: Theory and practice (2nd ed.)*. Thousand Oaks, CA: SAGE Publications.
- True, A. C. (1929). *A history of agricultural education in the United States 1785-1925*. Washington, D. C.: The U.S. Department of Agriculture.
- Tucker, M., Whaley, S.R., & Cano, J. (2003). Agricultural Education and Agricultural Communications: Striking a proper balance in the academy. *Journal of Agricultural Education*, 44(1), 22-30.

Comparisons of Agriculture Instructor and Student Perceptions of Social Media in Education

*Quisto Settle, Dr. Ricky Telg, Lauri M. Baker, Dr. Tracy Irani, University of Florida;
Dr. Tracy Rutherford, Dr. Emily Rhoades, Texas A&M University*

The purpose of this study was to provide an exploratory description of social media use in education by agriculture instructors and students. College agriculture students and instructors were surveyed regarding social media as education mediums. Findings showed that the majority of students and instructors have used social media for educational purposes. How social media were used varied by social media type. Online forums were the only social media type instructors were interested in presenting instructional information through. Students were not interested in having instructional information presented through social media. Instructors and students expected social media use in education to increase communication and decrease quality of student work, but they held differing views on effects to student productivity and quality of communication. Instructors perceived social media to be more important for students' future careers than students perceived them to be. The majority of instructors and student have used social media in education despite negative views toward social media in education, which indicates future research is needed. Recommendations include determining differences in perception between those who have used social media in education and those who have not and studying specific cases of social media implementation to determine best practices.

Introduction

The effects of technology in education are viewed differently by instructors and students (Jones, 2002; Jones & Johnson-Yale, 2008). In a national survey, instructors reported e-mail use had increased and improved communication with students, but they were more likely to believe Internet use had hurt student work than to believe it had improved it (Jones & Johnson-Yale, 2008). In another national survey, students reported Internet use was beneficial to their education (Jones, 2002). The students also reported that the Internet had improved their relationship with professors. Rhoades Irani, Telg, and Myers (2008) also reported that students believed Internet use had been beneficial to them, though this attitude was not specific to education.

Computers are more pervasive on college campuses every day. A recent survey of computer ownership showed that 98.8% of agriculture students at a land-grant university owned a computer (Rhoades et al., 2008). This is an increase from a decade older study at another land-grant university that reported 62.3% of students owned a computer (Johnson, Ferguson, & Lester, 1999). The Internet has altered the way people are social with each other (Weinberger, 2002). Much of this change is due to the advent of social media, which has recently begun to be integrated as an educational medium. Social media are media whose "content has been created by its audience" (Comm, 2009, p. 2). Social media are built upon Web 2.0 platforms, which are recent Internet technologies that allow users to consume and create content (Thompson, 2007).

Thompson (2007) discussed the transition of higher education to meet the needs of Millennials. Millennials are students who were born after 1982 (Eubanks, 2003). Alluding to Millennials and

their connection to social media, Thompson stated that faculty members not using Facebook were “missing an opportunity to capitalize on their students’ involvement with (Facebook)” (p. 2). Rhoades et al. (2008) also reported that social media offer a “unique new teaching opportunity to instructors” (p. 114). Of the students surveyed by Rhoades et al., 85.2% had Facebook accounts. Facebook is the largest online social network with more than 500 million active users worldwide with 50% of its users logging on everyday (Facebook Statistics, 2010). Though it could be a boon for college educators, Thompson stated that it would take time for higher education to catch up to the capabilities offered by Web 2.0 technology, specifically their two-way communication capabilities.

Social media in education is beginning to be documented. Head and Eisenberg (2010) used focus groups and a survey to study student use of Wikipedia for coursework. Wikipedia is an online encyclopedia that has its content created by its users without the filters that a traditional encyclopedia has. The majority of surveyed students used Wikipedia even if they are explicitly told by instructors to not use Wikipedia. The students understood the limitations of Wikipedia and circumvented them by only using the site at the beginning of the research process. Wikipedia was used to get background on their topics. The students then went to more academic sources, which are the ones they cite. Wikipedia was not being used as a replacement for scholarly sources but instead as a supplement to find those sources (Head & Eisenberg, 2010).

Holmberg and Huvila (2008) documented a case of Second Life being used as part of a distance education course in Finland. Second Life is a three-dimensional world that allows its users to navigate it as avatars. Unlike alternative online environments, Second Life offers the ability to more closely model a real world learning environment; the students and the educator can be in the same physical location in the Second Life world, complete with chairs, desks, and a classroom. The majority of learners reported that barriers for asking questions and participating in discussions were lowered when using Second Life. Compared to other online environments, respondents said the site was more fun and lessened the psychological distance between students.

Because YouTube is being increasingly used in classrooms, health education faculty members’ use and perceptions of the site were assessed (Burke, Snyder, & Rager, 2009). YouTube was seen as a free source that could help the learning process. All of the faculty members who used YouTube reported that it was an effective teaching tool. The majority of the YouTube users were using the site for in-class discussions and providing informational materials. Negatives related to YouTube use were time spent tracking down appropriate videos and making sure the videos would work in the classroom.

Theoretical Framework

The theoretical framework for this study was Expectancy Violations Theory (West & Turner, 2007). The theory posits that in any interaction both parties involved have expectations for the behavior of the other person. When the other person deviates from the expectations, then a violation has occurred. A violation is deemed negative or positive based on the actual violation, the characteristics of the violator, the relationship between the persons in the interaction, and the context of the violation. Expectancy Violations Theory is rooted in proxemics, which is the study of personal space. While this refers to physical distance, the idea is applicable to psychological distance as well. Classroom settings are typically conducted at the public distance, which is not personal. The issue of territoriality is also of interest. Individuals are inherently protective of

what they consider their primary territories (i.e., territories that belong to that person exclusively). If students expect education to remain at a public distance, then any encroachment on their primary territory would be considered a violation of their expectations.

The introduction of social media into educational situations could constitute a violation of expectations. Settle, Telg, and Irani (2010) assessed opinions of students who were using Facebook as a discussion tool. Despite the results being mostly positive toward Facebook's use in that setting, there were still members of the class who reported being uncomfortable with using what they considered to be a personal Web site for educational purposes. It can be inferred that these students might have perceived a violation of expectation because Facebook was seen as personal space.

Purpose & Objectives

Because society has adopted social media so quickly and in ever-increasing numbers, educators are beginning to discover social media as an instructional tool. The purpose of this study was to provide an exploratory description of how social media are being used for education in colleges of agriculture. Researchers in agricultural education and related fields are researching social media and technology in education. In the past year, the topic accounted for 28 research posters at American Association for Agricultural Education conferences, but there were only three papers presented. Aside from one poster, the presentations were documenting specific cases of technology and social media, indicating a need for a more in-depth analysis of the topic on a larger scale. As it relates to the National Research Agenda, this study addresses the research priority areas to improve the success of agriculture students and to enhance the effectiveness of agriculture faculty for Agricultural Education in University and Postsecondary Settings (Osborne, n.d.). The objectives of this study were to

1. Compare student and instructor use of social media for education, and
2. Compare student and instructor perceptions of social media in education.

Methods

The populations for this study were college agriculture instructors and students. The sampling frame for instructors consisted of members of the American Association for Agricultural Education (AAAE) and attendees of the Southern Association of Agricultural Scientists (SAAS). There were 729 usable e-mail addresses for SAAS and 145 respondents, for a 19.9% response rate. For AAAE, there were 593 usable e-mail addresses on the AAAE listserv and 160 respondents, for a 27.0% response rate. Two response rates are being reported because it was not possible to match nonrespondents' e-mail addresses that could be on both lists because the addresses for the AAAE listserv were not available. There were 232 participating instructors, with 86 being members of both groups, 12 reporting they were members of neither group, and one not responding to the question. Only those who taught college courses were included in the sample. For the student population, the sampling frame consisted of 255 students from [university], 378 students from [university], and 532 students from [university] who were in agriculture courses, for a total sampling frame of 1165. The overall response rate for students was 39.5% ($N = 460$). Individuals who did not complete the questionnaire were removed from the study and are not included in the final sample sizes.

To handle potential nonresponse error, early respondents were compared to late respondents (Lindner, Murphy, & Briers, 2001). Operationally, the early respondents were the first 50% of respondents and late respondents were the last 50% of respondents. For instructors, the groups were not significantly different, indicating the results could be generalized past the sample for all items. For students, early and late respondents were significantly different on one item. That item, which will be indicated in the results, cannot be generalized beyond the sample.

Prospective participants were contacted using recommendations by Dillman, Smyth, and Christian (2009). Members of the sampling frames were sent three e-mail waves. The waves of e-mails were sent until the number of responses to each wave was too low to warrant more e-mails. The e-mails provided a brief description of the study as well as a link to the questionnaire they were being asked to complete. The instructor survey was conducted in the fall of 2009 and the student survey was conducted in the spring of 2010.

Facebook, non-Facebook social networking sites, blogs, microblogs (Twitter), wikis, online forums, and video-sharing sites (YouTube) were the types of social media addressed in the study. The questionnaire was based in part on questionnaires used by Rhoades and Aue (2010), which assessed social media use by agricultural communications practitioners, and Irani and Telg (2002), which addressed the technologies students believed they should know for future careers. Participants were asked to answer questions relating to how they have used social media in education, their interest for using social media in education, the effects of social media use on education, and the importance of social media for students' future careers.

A panel of experts consisting of faculty members from departments of agricultural education, communications, and related fields at three land-grant universities were used to assess face and content validity. A pilot test was also used to further ensure the validity of the instrument. Reliability was assessed *post hoc* using Cronbach's alpha. For the student assessment, reliability was .86 for interest in using social media for education, .90 for perceived importance of social media for future careers, and .83 for effects of social media on students in education. For the instructor assessment, reliability was .82 for interest in using social media for education, .91 for perceived importance of social media for future careers, and .79 for effects of social media on students in education.

Results

Social Media Use in Education

The majority of instructors (62.1%) and students (70.6%) have used social media for educational purposes. Compared to the other social media types, online forums were used by the most instructors for all three categories: assignments (33.2%), out-of-class discussions (42.7%), and communicating with students (33.2%) (Table 1). Non-Facebook social networking sites were used by the fewest instructors in all three categories. The primary purpose of use varied by social media type. For instance, more than twice as many instructors used Facebook for communication than for assignments or discussion. Blogs and video-sharing sites were used more for assignments and discussions than for communication.

Reported educational use by students showed online forums to be used the most for discussions (35.2%), Facebook was the social media used the most for communication (32.0%) and video-

sharing sites were the social media used the most for assignments (25.4%). Non-Facebook social networking sites were the least-used social media types for assignments (2.0%) and communication (4.3%), while microblogs were the least-used for discussions (4.1%). Similar to the results for instructors, how social media were used varied by social media type.

Perceptions of Social Media Use in Education

The majority of instructors were not interested in presenting instructional information through social media (Table 2). The majority of instructors were only interested in using online forums (66.1%) to present educational information. Video-sharing sites (67.1%), wikis (54.7%), and blogs (53.9%) were the social media types that majority of instructors were at least neutral or interested in using. Instructors were most opposed to using non-Facebook social networking sites (77.4%) and microblogs (64.2%) to present instructional information, which are the respondents who either replied mostly disagree or disagree in response to their interest in each social media type. Students were not interested in receiving instructional information through any social media. The majority were not interested in using all but video-sharing sites and online forums (i.e., they are the only social media types that did not have the majority of students opposed to them when you factor in neutral responses). Like instructors, students were most opposed to using non-Facebook social networking sites (83.2%) and microblogs (81.0%). Students were less interested than instructors for all social media types.

The majority of instructors (78.7%) expect communication with students would increase if social media were used for classes (Table 3). More instructors expected student productivity to increase (37.4%) with social media use than those who expected it to decrease (20.5%), and more expected the quality of communication to decrease (35.8%) than thought it would increase (31.8%). The majority (59.0%) expected no change would occur to the quality of student work. For students, the majority expected the amount of communication to increase (67.4%) and more expected an increase (42.2%) in the quality of communication than those who expected a decrease (32.2%). More students expected a decrease in student productivity (36.4%) and quality of work (35.8%) than those who expected an increase (30.7% & 21.4%, respectively). Compared to instructors, students had lower expectations for all categories except quality of communication.

Table 4 addresses how important instructors perceived social media to be for students' future careers. Online forums (72.1%), video-sharing sites (53.2%), blogs (52.6%), and Facebook (50.2%) were perceived as being at least probably important by the majority of instructors. Non-Facebook social networking sites (49.3%) and microblogs (38.3%) were seen as the least important, as defined by those who responded that the respective social media types were either probably not important or not important. The majority of students did not view any of the social media types as important for future careers. Online forums (40.4%) and Facebook (40.3%) were viewed as being at least probably important by more students than the other social media types. Non-Facebook social networking sites (65.6%) and microblogs (60.8%) were seen as the least important.

Table 1

Instructor (N = 232) and student (N = 460) educational usage of social media by type and purpose for use.

		Assignments (%)	Out-of-class Discussions (%)	Communication (%)
Facebook	Inst	4.3	9.9	28.4
	Stud	6.5	19.3	32.0
Non-Facebook	Inst	0.4	1.7	3.0
	Stud	2.0	4.3	3.9
Blogs	Inst	13.4	16.8	6.5
	Stud	9.6	12.2	5.2
Microblogs	Inst	3.9	4.7	7.8
	Stud	3.5	4.1	4.3
Wikis	Inst	17.7	10.3	9.1
	Stud	14.1	10.4	5.0
Video-sharing	Inst	26.7	25.4	6.0
	Stud	25.4	26.3	12.6
Online forums	Inst	33.2	42.7	33.2
	Stud	19.8	35.2	22.0

Note. Participants were able to select multiple purposes for each social media type, therefore totals do not accumulate to 100%.

Table 2

Instructor (N = 232) and student (N = 460) interest in having instructional information delivered through social media.

		Disagree (%)	Mostly Disagree (%)	Neutral (%)	Mostly Agree (%)	Agree (%)	M
Facebook	Inst	32.9	24.7	19.9	16.5	6.1	2.38
	Stud	43.1	20.3	21.1	10.7	4.8	2.14
Non-Facebook	Inst	53.2	24.2	18.6	3.5	0.4	1.74
	Stud	68.1	15.1	13.3	2.8	0.7	1.53
Blogs	Inst	27.6	18.5	31.0	17.7	5.2	2.54
	Stud	58.5	14.6	20.0	5.4	1.5	1.77
Microblogs	Inst	46.1	18.1	26.7	6.9	2.2	2.01
	Stud	67.5	13.5	15.5	2.6	0.9	1.56
Wikis	Inst	28.4	16.8	31.0	17.7	6.0	2.56
	Stud	58.4	14.2	19.8	5.7	2.0	1.79
Video-sharing	Inst	19.9	13.0	26.8	30.3	10.0	2.97
	Stud	26.5	12.8	32.8	20.7	7.2	2.69
Online forums	Inst	7.8	6.1	20.0	37.4	28.7	3.73
	Stud	35.9	11.3	27.4	19.8	5.7	2.48

Note. Participants responded once for each social media type. There is a separate total for each social media type for instructors and students. Due to rounding, totals may be slightly above or below 100%. Scale ranged from 1 = Disagree to 5 = Agree.

Table 3

Instructor (N = 232) and student (N = 460) perceptions of the effect of social media on students' class performance.

		Major decrease (%)	Moderate decrease (%)	No change (%)	Moderate increase (%)	Major increase (%)	<i>M</i>
Student productivity	Inst	7.0	13.5	42.2	35.2	2.2	3.12
	Stud	11.8	24.6	32.9	27.2	3.5	2.86
Quality of student work	Inst	8.7	18.3	59.0	13.5	0.4	2.79
	Stud	10.3	25.5	42.8	19.9	1.5	2.77
Amount of communication	Inst	3.5	6.1	11.7	62.6	16.1	3.82
	Stud	7.6	10.3	14.6	46.9	20.5	3.62
Quality of communication ^a	Inst	10.0	25.8	32.3	27.9	3.9	2.90
	Stud	12.5	19.7	25.6	31.5	10.7	3.08

Note. Participants responded once for each social media type. There is a separate total for each social media type for instructors and students. Due to rounding, totals may be slightly above or below 100%. Scale ranged from 1 = major decrease to 5 = major increase.

^aFor students, results for early respondents were significantly different from late respondents, meaning results cannot be inferred past study's sample.

Table 4

Instructor (N = 232) and student (N = 460) perceptions of the importance of social media for students' future careers.

		Not important (%)	Probably not important (%)	Neutral (%)	Probably important (%)	Important (%)	<i>M</i>
Facebook	Inst	13.9	19.9	16.0	32.0	18.2	3.21
	Stud	17.8	21.5	20.4	24.6	15.7	2.99
Non-Facebook	Inst	21.2	28.1	22.5	19.9	8.2	2.66
	Stud	39.6	26.0	23.6	7.0	3.7	2.09
Blogs	Inst	10.4	11.7	25.2	35.2	17.4	3.37
	Stud	26.1	22.6	26.3	19.5	5.5	2.56
Microblogs	Inst	18.6	20.3	25.5	22.1	13.4	2.91
	Stud	36.1	24.7	24.1	10.9	4.2	2.22
Wikis	Inst	10.9	13.1	27.1	31.9	17.0	3.31
	Stud	27.9	22.1	29.5	15.3	5.2	2.48
Video-sharing	Inst	8.7	12.1	26.0	35.5	17.7	3.42
	Stud	21.0	21.0	30.8	19.4	7.9	2.72
Online forums	Inst	5.7	6.1	16.1	41.7	30.4	3.85
	Stud	19.0	15.3	25.3	29.3	11.1	2.98

Note. Participants responded once for each social media type. There is a separate total for each social media type for instructors and students. Due to rounding, totals may be slightly above or below 100%. Scale ranged from 1 = not important to 5 = important.

Conclusions

The majority of instructors and students have used social media for education. Online forums were used the most by instructors for the uses addressed by the questionnaire. Students reported a different social media type as the most-used for each variety of use: online forums for discussions, Facebook for communication, and video-sharing sites for assignments. Microblogs and non-Facebook social networking sites were among social media types used the least by instructors and students for all three purposes. For both groups, there was segmentation for how a social medium tended to be used. Instructors use specific social media with a particular purpose in mind. The studies mentioned earlier in this article (Burke et al., 2009; Head & Eisenberg, 2010; Holmberg & Huvila, 2008) also documented social media being used with specific purposes in mind.

Online forums and video-sharing sites were the only social media types the majority of instructors were interested in using to present instructional information. The majority of students were not interested in having instructional information presented through any social media type. Students were least opposed to the use of video-sharing sites and online forums. Both groups were most opposed to non-Facebook social networking sites and microblogs.

Instructors and students expected an increase in communication if social media were used in education. More participants of both groups expected a decrease in the quality of student work as a result of social media implementation than those who expected it to increase. These are consistent with the results from Jones and Johnson-Yale (2008) where instructors believed e-mail had increased communication but that Internet use had hurt student work. These results are not consistent with the results from Jones (2002) where students reported that Internet use had helped their education. Except for the quality of communication, students had lower expectations for the results social media implementation would have on students.

Instructors perceived social media as being more important to future careers of students than students perceived them to be. Instructors reported online forums and blogs would be the most important, while students reported Facebook and online forums would be most important. Non-Facebook social networking sites and microblogs were perceived as least important to students' future careers by both groups.

The results of this study indicate that instructors and students do not reach consensus regarding the role of social media in education. Instructors implementing social media in their classes need to be informed as to what their students' receptiveness to social media in education is. Using social media in education because students use social media in their personal lives is not a sufficient argument. Implementation should be done purposefully and in an informed manner based on research that addresses best practices specifically for social media.

The limitations of this study are that participants for both sampling frames and schools for the student portion were not randomly selected. This means the results of this study cannot be generalized beyond the sampling frames. Faculty results can only be generalized to AAEE and SAAS members, and student results can only be generalized to students of the respective universities. Also, due to the exploratory nature of this study and descriptive statistics used, causes of these results cannot be determined.

Recommendations

While this study provides a broad understanding of social media in education, more research should be conducted to assess specific cases of social media implementation. Though there is research available in agriculture relating to specific cases (e.g., the majority of the AAAE posters on the topic assessed specific cases), more in-depth analysis of specific applications is needed to better understand the nuances of social media implementation in education. Regardless of interest, the majority of instructors and students are using social media in education. A better understanding of best practices for social media implementation is needed. Future research needs to determine why certain social media are used for one purpose and not for another. More specifically, it should be determined if specific types of social media should be used for specific purposes. This would help to inform the practice of teaching and implementation of social media into educational settings.

As it relates to Expectancy Violations Theory, the introduction of social media is likely to be considered a violation in many settings where social media are used by instructors and students. It has already been shown that using Facebook in education could constitute a violation by students because the site is seen as an inherently personal space, not something students necessarily want to share with instructors (Settle, Telg, & Irani, 2010). Future research should be conducted to determine which social media students consider personal. Additionally, if instructors choose to implement social media in their classrooms, they should communicate the difference between social media for personal use and professional use, specifically focusing on the importance of social media use to students' future careers.

Distance education technologies and implementation could be beneficial to the discussion of social media implementation. There has been past research in students' receptiveness, expectations, and interest in distance education courses that have shown students have more positive results if they have experience with distance courses when compared to those who did not have the same amount of experience with distance courses (Diebel & Gow, 2005; Moore & Wilson, 2005; Witt & Wheelless, 1999). It should be determined if this similar relationship of experience and expectations occurs with social media in education. Comparisons of interest and expectations for specific social media types should be made between students and instructors who have used that social media type for education and those who have not used that social media type for education.

Though distance courses are not seen as favorably as live courses (Diebel & Gow; Moore & Wilson, 2005), they are still pursued as a viable option (Koch, Townsend, & Dooley, 2005; Mink & Moore, 2005). The majority of agricultural education departments and programs surveyed by Roberts and Dyer (2005) had distance programs. It is possible that social media could be implemented into education in a similar fashion: not seen as favorably as traditional classes and techniques but adequate enough to be used when necessary. A better understanding is needed regarding the role of social media as a supplement to traditional means of delivery and of social media as a replacement for traditional means of delivery in education.

While a violation would likely occur, that does not mean the end result will be good or bad; it simply means there would be a deviation from expectation. Knowing this violation is likely to occur in many instances, it is up to instructors who are interested in adopting social media for

educational use to be aware that students could react adversely. Care must be taken to ensure the social media being implemented are used correctly and purposefully to minimize these adverse reactions. Implementing social media for the sake of implementing social media could prove hazardous. If instructors use the medium incorrectly or it is perceived by students as being for the benefit of the instructor and not the students, then the introduction of social media could go awry.

References

- Bitner, N., & Bitner, J. (2002). Integrating technology into the classroom: Eight keys to success. *Journal of Technology and Teacher Education*, 10(1), 95-100. doi: 10.1037/0022-0167.32.1.94
- Burke, S. C., Snyder, S., & Rager, R. C. (2009). An assessment of faculty usage of YouTube as a teaching resource. *The Internet Journal of Allied Health Sciences and Practice*, 7(1), 1-8. Retrieved from <http://ijahsp.nova.edu>
- Comm, J. (2009). *Twitter power: How to dominate your market one tweet at a time*. Hoboken, NJ: John Wiley & Sons, Inc.
- Dillman, D. A., Smyth, J. D., & Christian, L. M. (2006). Implementation procedures. In *Internet, mail, and mixed-mode surveys: The tailored design method* (3rd ed., pp. 234-299). Hoboken, N.J.: John Wiley and Sons, Inc.
- Eubanks, S. (2003). Executive summary of the book *Millennials go to college*, by N. Howe and W. Strauss. Retrieved from <http://eubie.com/millennials.pdf>
- Facebook Statistics. (2010). *Facebook press room statistics*. Retrieved from <http://www.facebook.com/press/info.php?statistics>
- Head, A. J., & Eisenberg, M. B. (2010). How today's college students use Wikipedia for course-related research. *First Monday*, 15(3). Retrieved from <http://firstmonday.org/htbin/cgiwrap/bin/ojs/index.php/fm/index>
- Holmberg, K., & Huvila, I. (2008). Learning together apart: Distance education in a virtual world. *First Monday*, 13(10). Retrieved from <http://firstmonday.org/htbin/cgiwrap/bin/ojs/index.php/fm/index>
- Irani, T., Telg, R. W. (2002). Gauging distance education students' level with technology and perceptions of self-assessment and technology training initiatives. *Journal of Applied Communications*, 86(2), 45-55.
- Johnson, D. M., Ferguson, J. A., & Lester, M. L. (1999). Computer experiences, self-efficacy and knowledge of students enrolled in introductory university agriculture courses. *Journal of Agricultural Education*, 40(2), 28-37. doi: 10.5032/jae.1999.02028

- Jones, S. (2002). *The Internet goes to college: How students are living in the future with today's technology*. Retrieved from Pew Internet & American Life Project website: <http://www.pewinternet.org/>
- Jones, S., & Johnson-Yale, C. (2005). Professors online: The Internet's impact on college faculty. *First Monday*, 10(9). Retrieved from <http://firstmonday.org/htbin/cgiwrap/bin/ojs/index.php/fm/index>
- Koch, S., Townsend, C. D., & Dooley, K. E. (2005). A case study comparison between web-based and traditional level academic leadership instruction. *Journal of Agricultural Education*, 46(4), 72-82. doi: 10.5032/jae.2005.04072
- Lindner, J. R., Murphy, T. H., & Briers, G. E. (2001). Handling nonresponse in social science research. *Journal of Agricultural Education*, 42(4), 43-53. doi: 10.5032/jae.2001.04043
- Mink, J. L., & Moore, L. L. (2005). Evaluation of the distance education degree program available to students through the college of agricultural and life science. *Journal of Agricultural Education*, 46(4), 83-95. doi: 10.5032/jae.2005.04083
- Osborne, E. W. (Ed.) (n.d.). *National research agenda: Agricultural education and communication, 2007-2010*. Gainesville, FL: University of Florida, Department of Agricultural Education and Communication.
- Rhoades, E., & Aue, K. (2010, February). *Social agriculture: Adoption of social media by agricultural editors and broadcasters*. Paper presented at 2010 Southern Association of Agricultural Scientists' Conference, Orlando, FL.
- Rhoades, E. B., Irani, T., Telg, R., & Myers, B. E. (2008). Internet as an information source: Attitudes and usage of students enrolled in a college of agriculture course. *Journal of Agricultural Education*, 49(2), 108-117. doi: 10.5032/jae.2008.02108
- Roberts, T. G., & Dyer, J. E. (2005). A summary of distance education in university agricultural education departments. *Journal of Agricultural Education*, 46(2), 70-82. doi: 10.5032/jae.2005.02070
- Settle, Q., Telg, R., & Irani, T. (2010). The Facebook factor: Social media in a graduate course. *Proceedings of the American Association for Agricultural Education Southern Region Conference*, 109-111. Retrieved from <http://aaaeonline.org/index.php>
- Thompson, J. (2007). Is education1.0 ready for Web 2.0 students? *Innovate*, 3(4). Retrieved from <http://www.innovateonline.info/>
- Weinberger, D. (2002). *Small pieces loosely joined: A unified theory of the Web*. Cambridge, MA: Perseus Publishing.
- West, R., & Turner, L. H. (2007). *Introducing communication theory: Analysis and application*. New York, NY: McGraw-Hill.

Witt, P. L., & Wheelless, L. R. (1999). Nonverbal communication expectancies about teachers and enrollment behavior in distance learning. *Communication Education, 48*(2), 149-154. doi: 10.1080/03634529909379162

Information and Communication Technology Tasks Required in Undergraduate Agriculture Courses

Cassandra Cox, Leslie Edgar, Karisha Munise, Don Johnson, University of Arkansas

Abstract

Information and communication technology (ICT) play an important and ever increasing role in modern agriculture. The purpose of this study was to assess required ICT task requirements in selected undergraduate agriculture courses in a land-grant university. Faculty members (n = 63) in a college of agriculture were surveyed to determine the ICT tasks they required students to complete in identified courses during the fall 2009 semester. A mean of 8.46 (SD = 6.20) tasks was required per course. The six tasks required in more than one-half of all courses were: receive e-mail (80.7%), send e-mail (73.7%), search the Internet (64.9%), send e-mail attachments (57.9%), use Blackboard® (54.4%), and type a lab or project report (52.6%). Of 40 specific tasks, 19 were required in less than 10% of all courses. The least frequently required tasks included: program a database (0%), create an Excel® pivot table (1.8%), create a spreadsheet macro (1.8%), use file transfer software (1.8%), and create a webpage (3.5%). There were significant ($p < .05$), positive correlations between faculty members' self-perceived computer competency and the number of spreadsheet tasks required and between course level and the number of word processing, spreadsheet, computer graphics, miscellaneous, and total ICT tasks. A majority of faculty members planned to maintain their current level of required ICT use. Most undergraduate agriculture courses require a core of basic ICT tasks, but few intermediate or high-level tasks.

Introduction

In today's higher education classrooms, students can readily access information and communicate with their peers through diverse formal and informal means. Often, faculty members perceive students as technologically savvy because of their constant interaction with multiple mediums in diverse contexts (Edgar, Edgar, & Killian, 2009). However research shows that although students are highly engaged in social networking (Edgar, Amaral, & Edgar, 2009), they are not proficient in information and communication technology (ICT) needed in the workforce (Graham, 2001; Kaminski, Switzer, & Gloeckner, 2009).

Proficiency with information and communication technology (ICT) is a requirement for success in most well-paying careers (Grant, Malloy, & Murphy, 2009; Levy & Murnane, 2004; Stone & Madigan, 2007). Bresnahan, Brynjolfsson, and Hitt (2002) found that ICT has played a large and widespread role in shifting relative wages among those in the top, middle, and bottom of the US income distribution since 1980, with higher pay going to those with greater ICT skill levels. Most college of agriculture graduates will need ICT skills to enter and advance in their careers (Graham, 2001).

Many in higher education believe students enter college already proficient in ICT skills and use (Kaminski et al., 2009). However, research (Grant et al., 2009; Kaminski et al., 2009; Leonard & Patterson, 2004; Tesch, Murphy, & Crable, 2006; Wallace & Clariana, 2005) does not support this belief. These and other researchers have found that, while students perceived

themselves to be ICT literate, most could not successfully complete fairly basic ICT tasks. Ratliff (2009) posited that many students have the ‘wrong’ type of ICT skills for academic purposes. According to Ratliff, “Students may be experts with chatting, Twittering, or social networking, but be inexperienced in attaching a document to an e-mail or creating an essay with word processing software” (p. 1).

Several recent studies support Ratliff’s (2009) conclusions concerning student ICT skills. Tesch et al. (2006) found that 10% or fewer entering business students at Xavier University could correctly use absolute cell addresses in Excel® or properly insert a clip art image into a Word® document. Students at Northwest Missouri State University scored a mean of 53% correct on a basic competency assessment designed to allow them to test out of a required ICT literacy course (Hardy et al., 2006). Of 164 students completing the exam, only three students (1.8%) achieved a score of 80% or higher and were able to test out of the course. The researchers concluded that “a majority of the students have not mastered computer concepts, word processing skills, spreadsheet skills, presentation skills, or database skills” (p. 59). Johnson and Wardlow (2004) found that entering agriculture students at the University of Arkansas had fairly low levels of ICT knowledge and cautioned faculty not to assume that entering students possessed basic ICT skills.

The lack of ICT knowledge and skills is not limited to entering college students. Shrestha (2009) found that while graduating seniors in the College of Agriculture and Natural Resources at Michigan State University believed their academic majors had helped them develop the technical skills required in their anticipated careers, they felt their programs had not been effective in developing their ICT skills. The *National Research Agenda for Agricultural Education and Communication* (Osborne, n.d.) calls upon agricultural communication and education faculty to build competitive societal knowledge and intellectual capabilities, as well as develop effective agricultural work forces for knowledge-based societies. Through this charge and others it is critical for educators to determine effective ways to increase ICT skills in college students prior to entering the workforce.

Conceptual / Theoretical Framework

Rogers (1995) Diffusion of Innovation and the Technology Acceptance Model were theories that guided this study. Additionally, multiple researchers guided this conceptually.

Diffusion focuses on a person’s willingness to try new products or “innovations” (Atkin, Jeffres, & Neuendorf, 1998). By looking at information and communication technologies as technological innovations, diffusion theory can provide insight in to how people are accepting new technologies. Diffusion, defined by Rogers (1995), is the process by which an innovation is communicated through certain channels over time among members of a social system. The process of adoption of innovations, like new technologies, follows a five sequential stage model described by Rogers (1995). The steps are:

1. knowledge about, or exposure to the innovation’s existence;
2. persuasion or forming a favorable or unfavorable attitude toward the innovation;
3. the decision to adopt or reject the innovation;
4. implementation when an individual puts the innovation to use;
5. and conformation or reinforcement of the decision (p. 161).

The Technology Acceptance Model (TAM) is a theoretical framework that can be used to look at how agricultural classrooms are accepting ICT into their curriculum. TAM explains the psychological determinants of acceptance behavior and attitudes toward technology (Roberts & Henderson, 1998). TAM is based on a proven framework, the theory of reasoned action (TORA) (Fishbein & Ajzen, 1975), which provides the rationale for many assumptions seen in TAM (Davis, 1993). Fishbein and Ajzen (1975) noted that attitudes are a function of a belief about an object, and those beliefs lead to the behavioral intention toward that object. If the intention is not changed by some other factor it will lead to behavior. This theory allows TAM to draw a distinction between attitude toward the object and attitude toward the behavior (Davis, 1993).

Davis (1993) found in a study of business professionals that usefulness exerts more than twice the influence on use than does attitude toward using, and usefulness exerts more than four times the influence on attitude as does ease of use. Davis viewed computer usage to be motivated extrinsically, by having concern over gain in performance and associated rewards, (Davis, 1993). Yi and Venkatesh (n.d.) described the concept of self-efficacy with respect to understanding users' behavior in accepting technology. The research contended that an individual who has a strong sense of capability in dealing with computers is more likely to accept new technology, such as ICT. TAM research has been extensively conducted to look at how certain technology systems are being perceived and used. Davis (1993) found in a study of 112 users regarding two-end user systems, that "TAM fully mediated the effects of system characteristics on usage behavior" (p. 475). This study found that perceived usefulness was 50% more influential on attitude than ease of use in determining usage (Davis, 1993). A person's intention toward using a given system is determined by the extrinsic and intrinsic rewards of using the system (Davis, 1993).

In a study comparing TAM with the theory of planned behavior (TPB), Mathieson (1991) found that TAM was easier to apply and had empirical advantage over TPB. Mathieson (1991) stated that:

Ease of use (EOU) explains a significant amount of the variance in usefulness (U). EOU and U contribute to intention (I). Given the usual size of correlation coefficients in behavioral research, the multiple correlation coefficients are quite large. TAM is successful in explaining intention. (p. 184)

Agarwal and Prasad (1997) found "perceptions of compatibility, that is, the extent of behavior modification the use of innovation necessitates on the part of potential adopters, appears to be the most important predictor of current usage, while relative advantage is the dominant predictor of future use intentions" (p. 569).

Kuth and Vesper (2001) studied 125,000 graduates from 205 institutions and concluded that students making larger gains in ICT skills during college scored higher on each of 27 academic and social outcome measures when controlling for socioeconomic status. Based on these results, Kuth and Vesper recommended that all entering students become proficient in ICT early in their college careers and that universities examine how students use computers in their

courses. Additional empirical data is needed to understand the scope and level of college student ICT skills. This data will be critical in determining future areas of needs and focus.

Purpose and Objectives

The purpose of this study was to examine the ICT tasks required in undergraduate agriculture courses at a mid-Southern land-grant university during the fall 2009 semester. Specific objectives were to:

1. Determine the number and type of ICT tasks required in undergraduate agriculture courses;
2. Determine the relationship between course-level and instructor characteristics and ICT tasks required in undergraduate agriculture courses; and
3. Determine instructors' plans for ICT use in undergraduate agriculture courses over the next two to three years.

Methods

The population consisted of all undergraduate agriculture lecture courses ($N = 84$) taught at the University of Arkansas during the fall 2009 semester. Courses were identified using official records supplied by the dean's office. Sixty-four courses and their instructors were selected for the study using a two-step process. First, all courses of faculty ($n = 48$) teaching only one course in fall 2009 were selected for inclusion. Next, one course was randomly selected for each faculty member ($n = 16$) teaching two or more courses in fall 2009. Courses were selected in this manner so that the researchers could focus each respondent on one specific, identified course (rather than a generic or composite course) and still avoid asking faculty members to complete multiple surveys. Responses were received from 57 faculty members for a response rate of 89%.

An e-mailed cover letter invited faculty to participate, identified the specific course for which responses were sought, and contained a hyperlink for accessing the survey. In order to reinforce that respondents were to base their responses on the ICT tasks required of students in the specified course, the first survey item asked respondents to list the course code and number of the course for which they were responding as identified in the e-mail cover letter.

Data were collected using a three-part on-line survey. In Part One respondents indicated whether or not students enrolled in the selected course were required to complete each of 40 ICT tasks, grouped into seven areas, by selecting either a "Yes" or "No" response for each task. In addition to the specific tasks listed, each area of ICT use also contained an "Other (please specify):" response option. In Part Two, the respondents were asked to indicate their plans for required student ICT use in the course over the next two to three years. This section listed seven areas of computer use with the response options of "Decrease use," "Maintain current use," or "Increase use." Part Three contained four items concerning the respondents' academic rank, teaching experience and appointment, and self-perceived level of ICT skills.

A panel of nine faculty members (one from each department in the college) examined the instrument and judged it to possess face and content validity. Five faculty members at two different land-grant universities completed paper versions of the instrument (at two to seven week intervals) to determine instrument stability. Part One had a test-retest agreement

percentage of 95% and Part Two had a test-retest agreement percentage of 86%. The reliability of Part Three was not assessed since, according to Salant and Dillman (1994), “responses to non-sensitive demographic items are “subject to very little measurement error” (p. 87).

Results

Responses were received from faculty teaching courses in all nine academic departments in the college. The largest percentage of courses were at the junior level (40.4%), followed by courses at the senior (31.6%), freshmen (15.8%), and sophomore (12.3%) levels. This distribution of courses closely parallels the percentage of courses offered in fall 2009: junior (35.4%), senior (31.7%), freshmen (19.5%), and sophomore (13.4%). The typical faculty respondent held the rank of professor (61.2%), had 10 or more years of university teaching experience (69.4%), held a teaching appointment of 33% or less (67.4%), and rated their own ICT skills as average when compared to other faculty (65.3%).

The faculty respondents reported that a mean of 8.46 ($SD = 6.20$) ICT tasks were required in undergraduate agriculture courses in fall 2009. The largest mean numbers of tasks were from the Internet ($M = 2.47$; $SD = 2.50$) and e-mail ($M = 2.23$; $SD = 1.27$) areas, while the fewest were from the database ($M = 0.14$; $SD = 0.52$) and miscellaneous tasks ($M = 0.42$; $SD = 0.71$) areas (Table 1).

Table 1

Required Use of ICT Tasks in Undergraduate Agriculture Courses, by Area (n = 57)

ICT area	<i>M</i>	<i>SD</i>
Internet	2.47	1.89
e-mail	2.23	1.27
Spreadsheets	1.42	2.50
Word processing	1.07	1.12
Computer graphics	0.53	0.78
Miscellaneous tasks	0.42	0.71
Databases	0.14	0.52

Table 2 notes that over 50% of courses required one or more Internet, e-mail, and word processing tasks; less than 50% of courses required any computer graphics, spreadsheet, miscellaneous, or database tasks. The six tasks required in 50% or more of all courses were receive e-mail (80.7%), send e-mail (73.7%), search the Internet (69.4%), submit course assignments as attached e-mail files (57.9%), use Blackboard© to acquire course information (54.4%), and type a lab or project report (52.6%). Of the 40 specified ICT tasks, 27 were required in less than 25% of courses, while 19 were required in less than 10% of courses. Less than 15% of courses required students to use course listserves (10.5%), threaded discussion groups (10.5%), or Internet-based communications such as Facebook©, wikis, or blogs (12.3%) to participate in course activities or discussions. The least frequently required tasks were database programming (0.0%), use of file transfer software (1.8%), use of financial management

software (1.8%), creating PivotTables (1.8%), creating spreadsheet macros (1.8%), or preparing a brochure or newsletter using layout software (1.8%).

Table 2

Specific ICT Tasks Required in Undergraduate Agriculture Courses (n = 57)

Task	Required %	Not required %
Electronic mail	84.2	15.8
Receive electronic mail <i>from</i> you	80.7	19.3
Send electronic mail <i>to</i> you	73.7	26.3
Submit course assignments as "attached files"	57.9	42.1
Participate in an e-mail course discussion group or listserv	10.5	89.5
Other e-mail task(s)	0.00	100.0
Internet	79.0	21.0
Search the Internet for information on a specific topic	64.9	35.1
Utilize Blackboard to acquire course information.	54.4	45.6
Download data to disk or hard-drive from the Internet	40.4	59.6
Access a <i>homepage</i> developed for your course	31.6	68.4
Utilize Blackboard to submit assignments.	14.0	86.0
Utilize Internet-based communications to contact you (e.g. instant messages, Facebook, wiki, blog)	12.3	87.7
Participate in a "threaded discussion group" for your class	10.5	89.5
Download freeware	8.8	91.2
Create a webpage	3.5	96.5
Other Internet task(s)	7.0	93.0
Word processing	57.9	42.1
Type a lab or project report	52.6	47.4
Type a formal research paper	28.1	71.9
Type a business letter	8.8	91.2
Prepare a brochure or newsletter	3.5	92.5
Other word processing task(s)	14.0	86.0
Computer graphics	38.6	61.4
Create materials using presentation graphics software	33.3	66.7
Make drawings using computer-assisted drafting program	8.8	91.2
Create visual illustrations using graphic-design programs (e.g. Adobe Illustrator, Adobe Photoshop, etc.)	8.8	91.2
Prepare a brochure or newsletter using layout program (e.g. Adobe In-Design)	1.8	98.2
Other computer graphics task(s)	0.0	100.0
Spreadsheet	33.3	66.7
Enter data into an existing spreadsheet	29.8	70.2
Create charts and/or graphs using a spreadsheet	22.8	77.2
Create a new spreadsheet	21.0	79.0
Write a spreadsheet formula that performs a single mathematical operation	19.3	80.7
Use spreadsheet functions (e.g. IF, MAX, MIN, etc.)	17.5	82.5

Table 2 (continued)

Task	Required %	Not required %
Spreadsheet (continued)		
Write a single spreadsheet formula that performs a series of mathematical operations	15.8	84.2
Use spreadsheet database functions (e.g. sort, query)	8.8	91.2
Create a spreadsheet macro	1.8	98.2
Create PivotTables	1.8	98.2
Other task(s)	3.5	96.5
Miscellaneous	33.3	66.7
Conduct a literature search using Agricola, ERIC, FirstSearch or similar database	28.1	71.9
Use specialized applications	17.5	82.5
Write a computer program	3.5	96.5
Transfer files from a personal computer to a mainframe computer (or vice versa) using file transfer software (e.g. Telnet or SshClient)	1.8	98.2
Use a financial management program such as Quicken	1.8	98.2
Other miscellaneous task(s)	0.0	100.0
Database	8.8	91.2
Enter data into an existing database	3.5	96.5
Create a new database	3.5	96.5
Sort and/or query a database	3.5	96.5
Create a database report	3.5	96.5
Do database programming	0.0	100.0
Other database task(s)	0.0	100.0

There was no significant ($p > .05$) relationship between faculty rank, years of teaching experience, or FTE teaching and the number of required ICT tasks. However, faculty with higher self-perceived computer skills tended to require more spreadsheet tasks ($r = .32$). Course level had a significant ($p \leq .05$) positive correlation with the number of word processing ($r = .34$), spreadsheet ($r = .46$), computer graphics ($r = .36$), miscellaneous ($r = .33$), and total ($r = .35$) computer tasks required.

Faculty members were asked about their plans for required ICT use in the specified courses over the next two to three years (Table 3). (Note: respondents were not asked about their plans for miscellaneous tasks.) More than 60% of respondents planned to maintain their current level of required use in each ICT area. Fewer than 5% of faculty intended to decrease required student use of any ICT area. More than 25% of faculty intended to increase required use of computer graphics (29.2%), spreadsheets (32.6%), and the Internet (36.0%) over the next two to three years.

Table 3

Instructors' Plans for Required ICT Tasks over the Next Two to Three Years

ICT area	Decrease use %	Maintain use %	Increase use %
Word processing	0.0	77.6	22.4
e-mail	0.0	82.0	18.0
Internet	2.0	62.0	36.0
Spreadsheets	4.1	63.3	32.6
Databases	2.1	85.4	12.5
Computer graphics	0.0	70.8	29.2

Conclusions and Implications

The typical undergraduate agriculture course at this university required students to complete a mean of 8.46 ICT tasks in fall 2009, with six specific tasks being required in 50% or more of all courses. These six tasks were receive e-mail, send e-mail, search the Internet, submit course assignments as attached e-mail files, use Blackboard© to acquire course information, and type a lab or project report. Less than one-half of courses required students to complete any tasks related to spreadsheets, computer graphics, miscellaneous use, or databases. By and large, students were not required to complete ICT tasks designed to extend class discussion and participation beyond the classroom, such as use of course listserves, discussion groups, or wikis, blogs, and Facebook©. Undergraduate agriculture courses at this mid-south land-grant university tended to require limited student ICT use with most required tasks being drawn from a narrow range of fairly low-level ICT skills.

Faculty rank, teaching experience, and FTE teaching assignment were not significantly ($p > .05$) related to the number of ICT tasks required, either overall or by ICT task area. Self-perceived ICT competency had a significant ($p \leq .05$) positive correlation with the number of spreadsheet tasks required. Course level had a significant ($p \leq .05$) positive correlation with the number of word processing, spreadsheet, computer graphics, miscellaneous, and total ICT tasks required. Thus course level, as opposed to instructor characteristics, appears to be the best predictor of required student ICT use. While required ICT tasks did tend to increase in upper-level courses, the question arises as to whether overall and specialized ICT use requirements are sufficient to prepare graduates for effective ICT use in their careers (Graham, 2001). Further research in this area is needed.

By and large, faculty members planned to maintain their current levels of required ICT use in these courses over the next two to three years. Few faculty members planned to decrease use in any ICT area, while moderate increases were anticipated in each area. Thus, in the near term, future required student use of ICT is likely to increase at a fairly slow rate. Opportunities for faculty development should be provided in areas of ICT interest where competencies and skills are lacking in an effort to increase adoption of course-relevant ICT tasks.

Findings from this study support the need for administrators and faculty to value and implement ICT skill development beyond the basics. Research indicates that students are

entering college with ICT skills most suited for social networking (Ratliff, 2009). If agriculture students are to gain the level of ICT proficiency desired by graduates (Shrestha, 2009) and employers (Graham, 2001), it seems reasonable that students must first learn these skills and then be required to practice their use in appropriate courses throughout their undergraduate careers (Kuth & Vesper, 2001). If ICT instruction and use in the classroom do not provide students with these experiences, are we adequately preparing them to deal with the requirements of the current and future workforce?

In previous years, college goals at the University of Arkansas have focused on increasing the development and use of ICT skills in the classroom. Although it is not feasible or necessary to include every outlined skill in university curriculum, it is critical for administrators and faculty to understand the educational and workplace value of ICT skills. Nationally, institutions should ensure / enact policy regarding teacher competencies in ICT. ICT skills of importance and value should be integrated into course syllabi in an effort to create successful outcomes in teaching and learning that are content specific. Additionally, information and communication technology should be selected based on learning strategies and resources needed as necessary for the course.

While all instructors should be encouraged and assisted in integrating appropriate ICT requirements into their courses, required "ICT intensive" courses should be developed at either the department or college level. Assignments in these courses should be designed to require a variety of higher-level ICT tasks appropriate for the subject matter. The details of this or similar plans should be determined by the faculty, possibly through an ad hoc committee established for this purpose or by the college curriculum committee.

Finally, given the importance of ICT to career success (Graham, 2001) and graduating seniors' perceptions concerning inadequate ICT skills (Shrestha, 2009), other agriculture colleges and departments should examine required student ICT use in their courses. Information from such studies should prove useful in designing appropriate educational experiences to prepare graduates for career entry and advancement.

References

- Agarwal, R. & Prasad, J. (1999). Are individual differences germane to the acceptance of new information technologies? *Decision Sciences*, 30(2), 361-391.
- Atkin, D. J., Jeffres, L.W., & Neuendorf, K. A. (1998). Understanding internet adoption as telecommunications behavior. *Journal of Broadcasting & Electronic Media*, 42(4), 475-490.
- Bresnahan, T. F., Brynjolfsson, E., & Hitt, L. M. (2002). Information technology, workplace organization, and the demand for skilled labor: firm-level evidence. *The Quarterly Journal of Economics*, 117(1), 339-376.
- Davis, F. D. (1993). User acceptance of information technology: System characteristics, user perceptions and behavioral impacts. *International Journal of Man-Machine Studies*, 38, 475-487.

- Edgar, D. W., Amaral, K., & Edgar, L. D. (2009). Networks of communication and knowledge transfer among students in a college of agriculture introductory course. *Proceedings the National Agricultural Education Research Conference*, Reno, NV.
- Edgar, D. W., Edgar, L. D., & Killian, T. S. (2009). Networks of communication among students in a college of agriculture course. *NACTA Conference Proceedings*, Stillwater, OK.
- Fishbein, M. & Ajzen, I. (1975). *Belief, attitude, intention and behavior: An introduction to theory and research*. Reading, MA: Addison-Wesley.
- Grant, D. M., Malloy, A. D., & Murphy, M. C. (2009). A comparison of student perceptions of their computer skills to their actual abilities. *Journal of Information Technology Education*, 8, 141-160.
- Graham, D. L. (2001). Employer perceptions of the preparation of agricultural and extension education graduates. *Journal of Southern Agricultural Education Research*, 51(1), 88-101.
- Hardy, C., Heeler, P., & Brooks, D. (2006). Are high school graduates technologically ready for post-secondary education? *Journal of Computing Sciences in Colleges*, 21(4), 52-60.
- Johnson, D. M. & Wardlow, G. W. (2004). Computer experiences, self-efficacy, and knowledge of undergraduate students entering a land-grant college of agriculture by year and gender. *Journal of Agricultural Education*, 45(3), 53-64.
- Kaminski, K., Switzer, J., & Gloeckner, G. (2009). Workforce readiness: a study of university students' fluency with information technology. *Computers and Education*, 53, 228-233.
- Kuth, G. D. & Vesper, N. (2001). Do computers enhance or detract from student learning? *Research in Higher Education*, 42(1): 87-102.
- Leonard, J. G. & Patterson, T. F. (2004). Simple computer graphing assignment becomes a lesson in critical thinking. *NACTA Journal*, 48(2), 17-21.
- Levy, F. & Murnane, R. J. (2004). *The new division of labor: How computers are creating the next job market*. Princeton, NJ: Princeton University Press.
- Mathieson, K. (1991). Predicting user intentions: Comparing the technology acceptance model with the theory of planned behavior. *Information Systems Research*, 2(3), 173-191.
- Ratliff, V. (2009). Are college students prepared for a technology-rich learning environment? *Journal of On-line Teaching and Learning*, 5(4), 1-6.
- Rogers, E. (1995). *Diffusion of Innovations* (Fourth Edition), New York: Free Press.

- Salant, P. & Dillman, D. A. (1994). *How to conduct your own survey*. New York: John Wiley and Sons, Inc.
- Shrestha, K. M. (2009). Students' perspectives on the undergraduate education in the College of Agriculture and natural resources at Michigan State University. PhD Diss., Dept. of Community, Agriculture, Recreation and Resource Studies, Michigan State Univ., East Lansing, MI.
- Stone, J. A. & Madigan, E. (2007). Inconsistencies and disconnects. *Communications of the ACM*, 50(4), 76-79.
- Tesch, D. B., Murphy, M., & Crable, E. (2006). Implementation of a basic computer skills assessment mechanism for incoming freshmen. *Information Systems Education Journal*, 4(13), 1-11.
- Wallace, P. & Clariana, R. B. (2005). Perception versus reality – determining business students' computer literacy skills and need for instruction in information concepts and technology. *Journal of Information Technology Education*, 4, 141-151.
- Yi, M. Y., & Venkatesh, V. (n.d.). Role of computer self-efficacy in predicting user acceptance and use of information technology. Retrieved October 12, 2010, from <http://amcis1996.aisnet.org/papers/mun.htm>

Enhancing Collaboration among Math and Career and Technical Education Teachers: Is Technology the Answer?

A. Christian Morgan

Assistant Professor, University of Georgia

Brian Parr

Assistant Professor, Auburn University

Nick Fuhrman

Assistant Professor, University of Georgia

Abstract

Teacher collaboration has long been recognized as a vital component to student success. Recently, a method of achieving this collaboration was developed by researchers from the National Research Center for Career and Technical Education (Stone, Alfeld, Pearson, Lewis, & Jensen, 2006). This project represents an evaluation of the researchers' initial efforts toward providing in-service education for teachers focused on collaboration between math and CTE teachers. The multi-fold purpose of this study was to describe selected characteristics of secondary level teachers of math and CTE, to describe their perceptions concerning the "value of" and their "willingness to implement" the instructional practices and activities that were presented during a July 2010 professional development seminar, and to assess their views about the use of emerging technology as tools for teacher collaboration. Survey responses and construct summated scale scores indicate that using the Math-in-CTE Model was valued (41.85/50). Overall, respondents valued technology (16.58/20) but seemed a bit reserved about the likelihood of implementing and using technology (15.07/20). Time was the most prevalent barrier acknowledged, especially having coinciding planning periods with potential collaborators.

Introduction / Theoretical Framework

Contextualized learning has been shown to have many positive effects for secondary students (Bottoms & Sharp, n.d.; Buriak, et al., 1996; Enderlin & Osborne, 1992; Glasgow, 1997; Parnell, 1996). While this experience may be provided to students through various approaches, formal integration of subject matter between disciplines in the secondary school holds many positive aspects for teachers and students alike (Chiasson & Burnett, 2001; Enderlin & Osborne, 1992; Myers & Dyer, 2006; Parr, Edwards, & Leising, 2006; Parr, Edwards, & Leising, 2008; Parr, Edwards, & Leising, 2009; Roegge & Russell, 1990).

Recently, a method of achieving this integration of subject matter was developed by researchers from the National Research Center for Career and Technical Education (Stone,

Alfeld, Pearson, Lewis, & Jensen, 2006). This model was designed as means by which career and technical education (CTE) teachers from various disciplines could integrate a deeper level of mathematical instruction within their respective disciplines by “uncovering” the embedded mathematics that were already in the curriculum and providing a more meaningful focus on those concepts. The need for increased student achievement in secondary mathematics in the United States is well established (Stone, Alfeld, & Pearson, 2008). The National Assessment of Educational Progress (NAEP) reported that in the year 2005, 39% of 12th grade students performed at a “Below Basic” level on the math portion of their assessment. What is more, 77% of students performed at a level lower than “Proficient” (National Center for Education Statistics, 2009). This plan for effective curriculum integration was termed the "Math-in-CTE" model (Stone, Alfeld, Pearson, Lewis, & Jensen, 2006, p. 10, Figure 1). This approach was developed through rigorous research methods and resulted in a plan that has proven to be an effective means of delivering mathematically-enhanced CTE lessons (Parr, Edwards, & Leising, 2006).

At the heart of this holistic approach to math instruction is the notion of teacher collaboration. Teacher collaboration has shown to be a very important component of effective implementation of the Math-in-CTE model. While this collaboration appears to be a valuable teaching and learning resource, it may not be accomplished easily. Earlier studies have shown that curriculum integration and the necessary teacher collaboration that is associated with this behavior has many barriers to being implemented. Enderlin and Osborne (1992) identified several of these barriers when considering the integration of agricultural education and science education. These barriers included insufficient planning time, incomplete teacher training as well as lack of administrative support. Through research, these authors determined that while contextualized learning proved to be very beneficial, the collaborative activities that were required were time consuming and sometimes difficult. Further, these researchers determined that science teachers must feel that contextualized learning is important and work cooperatively with agricultural teachers to achieve effective results. This reflects the vital importance of educating the general education teacher on the many benefits associated with contextual learning which requires a great deal of collaboration. Enderlin and Osborne focused on the integration of agricultural science and biology but it is reasonable to believe that the barriers are common to the integration of other areas and disciplines. Thompson (1998) also identified barriers to contextualized learning such as lack of preparation time, lack of knowledge concerning how to integrate subject matter, as well as a lack of administrative support. Warnick and Thompson (2002) described some barriers to integration from the perspective of the general education teacher. Through their study it was clear that a major barrier to collaboration was the general education teacher’s lack of agricultural knowledge. While nearly 80% of the science teachers questioned agreed that collaboration between the agriculture and science teachers could be beneficial to science students, the teachers were obviously unaware of how they could achieve integration with agricultural educators. The obvious solution to these barriers that prevent effective contextualized learning is sustained teacher collaboration, yet it is also obvious that this collaboration is happening on a limited basis (Stephenson, Warnick, & Tarpley, 2008).

Teacher collaboration has long been recognized as a vital component to student success. Garet, Porter, Desimone, Birman, and Yoon (2001) stated, “First, teachers who work together are more likely to have the opportunity to discuss concepts, skills and problems that arise during their professional development experiences” (p. 918). The authors also posited that, “. . .

teachers who share the same students can discuss students' needs across classes and grade levels" (p. 918). Balschweid, Thompson, and Cole (2000) studied the integration of science and agricultural education and, consequently, the collaboration between teachers in the two disciplines. The researchers stated,

Agricultural education teacher preparation graduates should be encouraged to participate in activities at their building sites which would foster relationships with members of the science department and general faculty to increase the opportunities for collaborative endeavors and for overall marketing of the secondary agricultural education program (p. 43).

Myers and Thompson (2009) recognized the value of teacher collaboration as evident in the following statement, "Collaboration with other academic teachers through crosscurricular projects will help students better understand the academic as well as technical concepts and principles" (p. 84). The researchers went on to say "These collaborative efforts will help agriculture teachers understand the importance and become stronger team members within the total educational community in developing the whole student" (p.84).

Many studies have shown the challenges associated with being a secondary teacher and especially the large time commitment required to be an agricultural educator (Delnero & Montgomery, 2001). In light of these facts, it would seem unreasonable to expect teachers to add another meeting to their frantic schedule. Emerging technology has provided a means for individuals to collaborate with a fraction of the time requirements associated with face to face encounters. Tools such as wikis, blogs, communities of practice, and a whole host of social networking programs e.g. Facebook, Twitter, MySpace etc. have made interaction between individuals much more time efficient and much less prohibitive in terms of scheduling (Friedel, Rhoades, & Morgan, 2009; Morgan & Parr, 2009). The question remains, how well prepared and willing are current teachers to implement the use of technology as a viable means for collaboration toward contextualized learning?

This project represents the researchers' initial efforts toward providing in-service education for teachers toward collaboration between math and CTE teachers. To that end, data were collected to determine the perceived needs of the teachers concerning their perceptions about their self-efficacy (Bandura, 1995; DeMoulin, 1993) for collaboration and the use of innovative technology as tools to accomplish this collaboration. The educators' views about "importance of" and "desire to implement" using methods they learned as a result of the in-service were conceptualized as "proxies" or indicators of their self-efficacy and related "planned behaviors" (Ajzen, 1991). Davis, Ajzen, Saunders, & Williams (2002) described three major factors that hold high relationships with human action (see Figure 1). These three factors were defined as; evaluation of the behavior ("attitude toward the behavior"), social pressure associated with the behavior ("subjective norm"), and self-efficacy in relation to performing the behavior ("perceived behavioral control", p. 811). Of the three aspects that Davis et al. described, self efficacy holds the strongest association with behavioral intention and the resulting behavioral engagement. Therefore, self-efficacy in the implementation of advanced technology for the purpose of teacher collaboration warrants evaluation to provide an indication of teachers' intentions to alter their behaviors as related to collaboration.

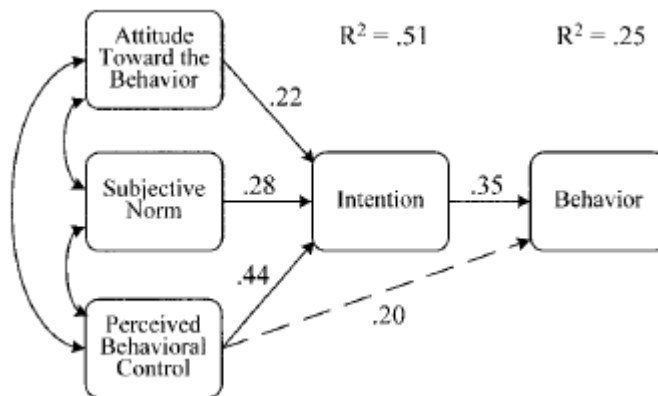

Figure 1. Path analysis for the theory of planned behavior. Taken from Davis, Ajzen, Saunders, & Williams (2002)

Many researchers (Myers & Thompson, 2009; Osborne & Dyer, 1998) have called attention to the need to systematically determine the best strategies for collaboration between teachers. The approach used in this study was designed to provide guidance for appropriate planning and implementation of future efforts to increase collaboration between math and CTE teachers and the application to agricultural education.

Purpose of the Study

The multi-fold purpose of this study was to describe selected characteristics of secondary level teachers of math and CTE, to describe their perceptions concerning the “value of” and their “willingness to implement” the instructional practices and activities that were presented during a July 2010 professional development seminar, and to assess their views about the use of emerging technology as tools for teacher collaboration. In addition, findings will be used to better inform providers of professional development regarding the relevance, appropriateness, and anticipated value of trainings on enhancing teacher collaboration using technology. What is more, this study served as a data point in the exploration of more effective means for teachers to collaborate so that they may “Enhance program delivery models for agricultural education” as called for in the National Research Agenda for Agricultural Education and Agricultural Communications .

Specifically, this study was guided by four objectives:

1. Determine the value that CTE teachers place on collaboration facilitated by the Math-in-CTE Model;
2. Describe the likelihood that such educators would implement the model in their teaching;
3. Determine the value that CTE teachers place on collaboration facilitated by technology (wiki’s, blogs, Google docs, and Facebook);

4. Describe the likelihood that these educators would use technology to enhance teacher-to-teacher collaboration.

Methods and Data Sources

Both qualitative and quantitative methods were used to collect data from 44 teachers of mathematics and CTE for this descriptive study. The participants attended a professional development seminar during the summer of 2010. Seminar topics were presented by two faculty members from four-year land-grant institutions. The researchers developed a questionnaire that elicited three categories of information: (a) personal/professional data; (b) assessments about the “importance of” and teachers’ self-perceived “ability to” perform the seminar’s topics (i.e., competencies); and (c) perceptions about trends in technology that could be used as tools for collaboration.

For this research a convenience sample was used to obtain data. This is an appropriate method when it is difficult to select a random or systematic non-random sample and has been used in previous studies (Fraenkel & Wallen, 2006; Jennings, Brashears, Burris, Davis, & Brashears, 2007; Smith, Park, & Sutton, 2007).

A researcher-developed instrument was piloted with a group of secondary educators at a national CTE conference following participation in a workshop highlighting the Math-in-CTE Model and collaborating using technology. The instrument contained two constructs and a series of demographic questions used to describe respondent gender, school size, and level of teaching experience. The first construct, Math-in-CTE Model and Core Subjects, fulfilled study objectives one and two and measured the value that educators place on using the Math-in-CTE Model during collaboration and the likelihood that they would implement the model (see Table 1). This construct contained five items with response options ranging from 1 (*no value and not likely*) to 10 (*highly value and highly likely*). The second construct, Technology, fulfilled study objectives three and four and measured the value that educators place on collaboration facilitated by technology and the likelihood that they would use technology to enhance collaboration (see Table 2). This construct contained two items with response options ranging from 1 (*no value and not likely*) to 10 (*highly value and highly likely*). Descriptive statistics, including frequencies, means, and standard deviations were used to summarize the data at the item level and to describe the respondents. Internal consistency was determined using Cronbach’s alpha. If an acceptable (≥ 0.70) internal consistency was found within a construct, mean summated scale scores were calculated within the construct.

Domain analysis (Spradley, 1980) was used to summarize responses to the open-ended items on the questionnaire. Color coding was used to categorize responses into themes and themes were then collapsed into broader domains. Domains were then ranked by how often they surfaced in the raw data.

Results

Respondent demographics

Six demographic questions were included in the questionnaire and were answered by most participants ($n = 44$). Respondents were composed of 25 females (57%) and 17 males

(39%), who had been teaching professionally 1 to 36 years ($M = 14.29$) and teaching at their current school 1 to 29 years ($M = 6.74$). Many teachers were early in their career, with 12 respondents teaching 0-5 years and seven teaching 6-10 years. Mid and late career teachers made up the remainder with six teaching 11-15 years, four 16-20 years, and 13 teaching more than 20 years. Similarly, most teachers had been teaching at their current school for five years or less ($n = 25$). Twenty-six respondents identified themselves as mathematics teachers and stated they taught the following subjects (some respondents taught more than one subject): algebra ($n = 14$), math ($n = 12$), geometry ($n = 4$), pre-calculus ($n = 4$), calculus ($n = 3$), and statistics ($n = 2$). In addition, 15 stated they were CTE teachers whose subjects included the following skill areas: business ($n = 5$), engineering or technical ($n = 4$), computer ($n = 3$), and automotive related ($n = 3$).

Respondents were asked to provide information about their schools as well. Student enrollment ranged from 34 to 5200, with a mean of 1078. Further analysis revealed that nearly half ($n = 20$) of the respondents were from schools with 501-1000 students, while nine schools had an enrollment of 1-500, six schools had an enrollment of 1001-1500, and four schools had an enrollment larger than 1501. When asked to describe their school as either rural, suburban, or urban, 18 respondents chose rural (41%), 14 suburban (32%), 8 urban (18%), and one used all three descriptors.

Objectives 1 and 2

Objective one was to determine the value that CTE teachers place on collaboration facilitated by the Math-in-CTE Model, while objective two was to describe the likelihood that such educators would implement the model in their teaching. Table 1 depicts the descriptive statistics at the item level and the internal consistency for the Math-in-CTE Model and Core Subjects construct.

Table 1. Descriptive statistics for Math-in-CTE Model and Core Subjects (Value $\alpha = 0.81$, Likelihood $\alpha = 0.88$, $n = 39$).

Item	Mean Value Score (SD) ^a	Mean Likelihood Score (SD) ^b
Discuss the Math-in-CTE Model with a teaching partner.	8.29 (1.68)	7.86 (1.75)
Use the Math-in-CTE Model in my own classroom at least once.	8.12 (1.75)	7.79 (2.25)
Embed the Math-in-CTE Model in my own classroom by using it more than once.	7.85 (1.84)	7.48 (2.19)
Partner with a teacher in my school to illustrate contextual applications, like those found in CTE courses, into core subject courses.	8.88 (1.40)	7.86 (2.10)
Partner with a teacher in my school to infuse core subject concepts into CTE coursework.	8.71 (1.49)	7.86 (2.14)

^a 1 (*no value*) to 10 (*highly value*)

^b 1 (*not likely*) to 10 (*highly likely*)

Items within the Math-in-CTE Model and Core Subjects construct had moderate to strong internal consistency (Table 1), warranting the creation of summated scale scores within the construct. This construct had a mean summated scale score of 41.85 (SD = 6.13) for the value teachers placed on incorporating the Math-in-CTE Model with core subjects. With minimum and maximum possible value scores of five and 50 for the construct, this implies that teachers place high value on integrating the Math-in-CTE Model with core subjects they teach. The mean summated scale score for the likelihood that teachers would incorporate the model was 38.79 (SD = 8.55). With minimum and maximum possible likelihood scores of five and 50 for the construct, this implies that teachers are likely, but not highly likely, to incorporate the model into their teaching.

Objectives 3 and 4

Objective three was to determine the value that CTE teachers place on collaboration facilitated by technology, and objective four was to describe the likelihood that these educators would use technology to enhance teacher-to-teacher collaboration. Table 2 depicts the descriptive statistics at the item level and the internal consistency for the Technology construct.

Table 2. Descriptive statistics for Technology (Value $\alpha = 0.96$, Likelihood $\alpha = 0.90$, $n = 39$).

Item	Mean Value Score (SD) ^a	Mean Likelihood Score (SD) ^b
Use technology (such as wiki's, blogs, Google docs, and Facebook) to communicate with other teachers at least once.	8.28 (1.74)	7.54 (2.11)
Implement technology to increase collaboration between career tech and mathematics teachers over time.	8.30 (1.62)	7.60 (1.96)

^a 1 (*no value*) to 10 (*highly value*)

^b 1 (*not likely*) to 10 (*highly likely*)

Items within the Technology construct had strong internal consistency (Table 2), warranting the creation of summated scale scores within this construct as well. The construct had a mean summated scale score of 16.58 (SD = 3.29) for the value teachers placed on using technology. With minimum and maximum possible value scores of two and 20 for the construct, this implies that teachers value, but do not highly value, the use of technology to enhance their teaching. The mean summated scale score for the likelihood that teachers would implement technology to increase collaboration was 15.07 (SD = 3.88). With minimum and maximum possible likelihood scores of two and 20 for the construct, this implies that teachers are less likely to use technology to enhance collaboration with other teachers. The qualitative findings presented below on the barriers to using technology to collaborate with colleagues provide further evidence concerning the possible reason for this lower likelihood.

Qualitative findings

Participants were asked to respond to two open-ended items on the questionnaire. The first item regarded the barriers which would keep participants from using technology for collaborating with colleagues. The second item asked participants to complete the statement, "When I think about the [Math-in-CTE Model], the take home message for me would be..." using a creative slogan or phrase similar to one which might appear on a bumper sticker.

Domain analysis revealed six major barriers which would keep participants from using technology to collaborate with colleagues. Because of space limitations raw data is not reported. Listed in order of prevalence, these barriers (domains) included: (1) "lack of a common planning period between math and CTE teachers," (2) "terminology/language," (3) "familiarity with technology," (4) "willingness to change," (5) "access to technology," and (6) "stereotyping math and CTE." Although respondents indicated a willingness to collaborate with math or CTE teachers, not having adequate time in the day to do so effectively was the strongest barrier.

Following examination of the take home messages/creative slogans generated by participants, three major domains surfaced. Listed in order of prevalence, these included: (1) "math as a teaching tool," (2) "math and CTE together make it real," and (3) "breaking boundaries to build bridges." Participants noted the link between math and CTE curricula and the ability of each to enhance the real-world relevance of course content to students.

Discussion, Conclusions, and Recommendations

The information found in this study provides valuable information for agricultural education teacher educators and people planning in-service opportunities for agricultural science teachers. The first and second objectives of the study were to determine the value that CTE teachers place on collaboration facilitated by the Math-in-CTE Model and the likelihood that educators would implement the model. Survey responses and construct summated scale scores indicate that using the Math-in-CTE Model was valued (41.85/50). When viewing individual item means, it appears that teachers were more comfortable discussing the Model with a colleague ($M = 8.29$) than they were with using the model within their own lessons more than once ($M = 7.85$). Perhaps this is an indicator of a cautious skepticism these educators have to altering existing curriculum. Yet, overall the educators appeared to value collaborating with colleagues to enrich their curriculum, which was underscored by their response to the item “Partnering in with a teacher in my school to illustrate contextual applications into core subject courses,” ($M = 8.88$). When tying this back to the theory of planned behavior, this indicates a positive evaluation of the behavior, increasing the intention of the individual to carry out the behavior, in this case to collaborate with their cross-disciplinary peers.

Similarly, the likelihood construct was positive as well (38.79/50), indicating that respondents were likely to implement the behaviors measured. Once again, the item scores indicate a possible cautious skepticism to curriculum change, and perhaps a desire for educators to learn more about using the Model and collaboration to develop a greater comfort level before implementing changes to their current coursework. When looking at the theory of planned behavior model, perhaps this would be associated with subjective norms; that is, because this is a new idea and they are not aware of other people in their school carrying out such collaboration, they are hesitant to be the pioneers in this area. This may indicate the need for social and administrative support for the implementation of new ideas such as cross disciplinary collaboration.

Objectives three and four focused on using technology to facilitate collaboration. First, determining the value that CTE teachers place on collaboration facilitated by technology and second to describe the likelihood that educators would use technology to enhance collaboration. Overall respondents valued technology (16.58/20) but seemed a bit reserved about the likelihood of implementing and using technology (15.07/20). Once again, when presented with a new or unfamiliar behavior, there appears to be some hesitance to embracing the behavior. When the qualitative statements are taken into consideration barriers emerge which may help explain the reservations observed in the likelihood construct. Statements such as “familiarity with technology” and “access to technology” indicate that not only does new technology create a barrier to carrying out a behavior, but easy access to technology may also be a challenge. In this day when the expectation is that every classroom has Internet access, the responses seem to indicate that other impediments, such as school internet filtering programs (firewalls) or a lack of access to computers, make it difficult for teachers to utilize existing technology. In addition, respondent age may be a factor, as over half of had been teaching for 11 years or longer ($n = 23$). Older teachers may not be as quick to explore new technologies as younger teachers.

Based on quantitative findings, it appears there is a good chance that the respondents would collaborate to embed the Math-in-CTE Model into their curriculum. Respondents saw value in the ideas presented and tended towards being likely to implement the ideas as well. Yet, the qualitative portion of the instrument revealed other barriers with which teacher educators and in-service program developers should be aware. Time was the most prevalent barrier acknowledged, especially not having coinciding planning periods with potential collaborators.

This is an important finding, as this issue is one that would have to be addressed by school administrators, hence the need for strong administrative support of these collaborative activities. Another barrier was “terminology/language” indicating the unfamiliarity with the vocabularies of the respective disciplines. CTE teachers need to be reminded of the mathematical terms used and math teachers will need to be introduced to the nomenclature of technical disciplines. Teacher educators can assist in the area by emphasizing common mathematical terms during teacher preparation and explaining to pre-service teachers the importance of sharing with math teachers the terminology commonly used in technical programs.. Others have also found a lack of sufficient preparation time to be a barrier to teacher collaboration (Enderlin & Osborne, 1992; Thompson, 1998).

When reflecting on the study it is interesting to note that if only the quantitative portion of the study were analyzed then the theory of planned behavior model would seem to indicate a high probability that teachers would implement the behaviors shared in the workshop. However, when examining the qualitative responses barriers emerge that were difficult to capture in the quantitative responses. Although respondents valued the information that was presented and even indicated their desire—i.e. likelihood—to apply the information, the barriers revealed may indicate that, regardless of a teacher’s desire to embrace a behavior or technology, there may be barriers which prohibit doing so, barriers that do not readily fit into the planned behavior model. A teacher can have a positive attitude towards a behavior, and self efficacy for the behavior, but without time or technology to implement the behavior then there is a high probability the behavior will not be performed.

Additional research to be conducted includes replicating this study with other groups of CTE, and specifically agricultural education teachers to determine if the findings of this study are similar to other populations. Also, future workshops should be developed to address barriers to collaboration and embedding the Math-in-CTE Model. Perhaps creating local or regional facilitators that can assist teachers to establish collaborative relationships and working with administrators will help to overcome perceived barriers. Finally, research should be conducted to determine if an additional variable should be added to the theory of planned behavior to accommodate barriers.

References

- Ajzen, I. (1991). The theory of planned behavior. *Organizational Behavior and Human Decision Processes*, 50(2), 179-211.
- Balschweid, M. A., Thompson, G. W., & Cole, R. L. (2000). Agriculture and science integration: A pre-service prescription for contextual learning. *Journal of Agricultural Education*, 41(2), 36-45.
- Bandura, A. (Ed.) (1995). *Self-efficacy in changing societies*. Cambridge: Cambridge University Press.
- Davis, L. E., Ajzen, I., Saunders, J., & Williams, T. (2002). The decision of African American students to complete high school: An application of the theory of planned behavior. *Journal of Educational Psychology*, 94, 810–819.

- Delnero, J., & Montgomery, D. (2001). Perceptions of work among California agriculture teachers. *Journal of Agricultural Education*, 42 (2), 56-67
- DeMoulin, D. F. (1993). Efficacy and educational effectiveness. In J. R. Hoyle & D. M. Estes (Eds.), *NCPEA: In a new voice* (pp. 155- 167). Lancaster, PA: Technomic Publishing Company, Inc.
- Enderlin, K. J., & Osborne, E. W. (1992). Student achievement, attitudes, and thinking skill attainment in an integrated science/agriculture course. *Proceedings of the 19th Annual National Agricultural Education Research Meeting* (pp. 37-44). St. Louis, MO.
- Fraenkel J. R. & Wallen, N. E. (2006). *How to design and evaluate research in education* (6th ed.) Boston: McGraw-Hill.
- Friedel, C. R., Rhoades, E. B., Morgan, A. C. (2009). Can Web 2.0 improve our collaboration? *Techniques* (84)1, 24-27. http://www.acteonline.org/uploadedFiles/Publications_and_E-Media/files/files-techniques-2009/Theme_3.pdf
- Garet, M. S., Porter, A. C., Desimone, L., Birman, B. F., & Yoon, K. S. (2001, Winter). What makes professional development effective? Results from a national sample of teachers. *American Educational Research Journal*, 38(4), 915- 945.
- Jennings, M., Brashears, T., Burriss, S., Davis, C. S., & Brashears, M. (2007). *A National Assessment of Beef Cattle Producers' Educational Needs Regarding Pre-Harvest Food Safety*. Paper presented at the AAAE National Research Conference, Minneapolis, MN.
- Morgan, C. & Parr, B. (2009). Using technology to increase collaboration between career tech and core subject teachers. *Techniques* (84)8, 48-52. http://www.acteonline.org/uploadedFiles/Publications_and_E-Media/files/files-techniques-2009/Research_Report%287%29.pdf
- National Center for Education Statistics. (2009). *National assessment of educational progress*. Retrieved from, <http://www.nces.ed.gov/nationsreportcard/naepdata>
- Osborne, E. W., & Dyer, J. E. (1998). Attitudes of Illinois high school science teachers toward educational programs in agriculture. *Journal of Agricultural Education*, 39 (1), 8-16
- Parr, B. A., Edwards, M. C., & Leising, J. G. (2006). Effects of a math-enhanced curriculum and instructional approach on the mathematics achievement of agricultural power and technology students: An experimental study. *Journal of Agricultural Education*, 47(3), 81-93.
- Parr, B. A., Edwards, M. C., & Leising, J. G. (2008). Does a curriculum integration intervention to improve the mathematics achievement of students diminish their acquisition of technical competence? An experimental study in agricultural mechanics. *Journal of Agricultural Education*, 49(1), 61-71

- Parr, B. A., Edwards, M. C., & Leising, J. G. (2009). Selected effects of a curriculum integration intervention on the mathematics performance of secondary students enrolled in an agricultural power and technology course: An experimental study. *Journal of Agricultural Education, 50*(1), 57-69
- Roegge, C. A., & Russell, E. B. (1990). Teaching applied biology in secondary agriculture: Effects on student achievement and attitudes. *Journal of Agricultural Education, 31*(1), 27-31.
- Smith, E. A., Park, T. D., & Sutton, M. (2007). *Effect of Location and Education on Perceptions and Knowledge about Agriculture*. Paper presented at the AAAE National Research Conference, Minneapolis, MN.
- Spradley, J. P. (1980). *Participant observation*. New York, NY: Holt, Rinehart, and Winston.
- Stephenson, L. G., Warnick, B. K., & Tarpley, R. S. (2008). Collaboration between science and agriculture teachers. *Journal of Agricultural Education, 49*(4), 106-119
- Stone, J. R., III, Alfeld, C., Pearson, D., Lewis, M. V., & Jensen, S. (2006). Building academic skills in context: Testing the value of enhanced math learning in CTE (Final study). St. Paul, MN: National Research Center for Career and Technical Education.
- Stone, J. R. III, Alfeld, C., & Pearson, D. (2008). Rigor “and” relevance: Enhancing high school students’ math skills through career and technical education. *American Educational Research Journal, 45*(3), 767- 795.
- Thompson, G. (1998). Implications of integrating science in secondary agricultural education programs. *Journal of Agricultural Education, 39*(4), 76-85.
- Warnick, B., & Thompson, G. (2002). Perceptions of Oregon science teachers regarding the integration of science into the agricultural education curriculum. *Proceedings of the 29th Annual National Agricultural Education Research Conference*. (CD-ROM, December 11, 2002 release, Las Vegas, NV.)

Animation: Friend or Foe in Today's Classrooms?

Ron D. Koch, Dr. Don W. Edgar, Dr. George W. Wardlow, University of Arkansas

Abstract

Agricultural Science classrooms hold a vast amount of knowledge for today's students. Through the advancement of technological devices, both hardware and software, the arsenal of today's teachers seems unlimited. Animation of intricate theories and processes has been touted to increase understanding of students and this study engaged in analyzing the effects of animation in purposively selected classrooms through a counterbalance design. Theories of operation and carburetion were taught to the selected participants. Regarding cognitive achievement of the selected participants towards principles and theories tested, no significant differences were found between technology enhanced and traditional means of education. Further variables of study including gender, time of instruction, and tinkering self-efficacy were not found to have significant effects. This study concurs with previous research that technology enhanced teaching does not significantly affect cognitive achievement.

Introduction

Technology has evolved society in recent decades. With technology becoming ever-more-important in today's economy, the workforce has also been affected (CORD, 1999). Just as technology has affected the way most jobs are addressed, technology has begun to play a huge role in education. The National Research Council (1988) called for instructors to seek out and share technology-enhanced instructional material for agricultural education to enhance student achievement. Based on the availability of technology related resources for today's teachers, it is paramount to understand the usage of these technologies in today's classroom. Furthermore, there are countless resources available for teachers which never before existed.

Digital technologies surround children growing up today. According to Phipps, Dyer, Osbourne, & Ball (2008), "students of the millennial generation spend an average of nearly 6.5 hours in front of some type of media each day" (p. 291). Coinciding with this premise, there leaves little time for physical activities like disassembling and troubleshooting mechanical devices as in previous generations. While the ways of teaching have begun to change, the students of today have changed. Learners are foundationally different from those who came before them in their methods of processing information and reasoning (Prensky, 2001).

The use of information and communication technology in a creative way as an alternative to lecture can bring more excitement and interest into the classroom (Clark, 2008). Through the technologies available, teachers can transform the classroom from a "teacher-centered" to a "learner-centered environment" in an effort to adapt to students' needs (Simonson & Thompson, 1997). With nearly all schools today having a computer in every classroom, technology can be associated with learning. "As agricultural education enters the twenty-first century, it must change with emerging trends in society and the agricultural industry," (Talbert, Vaughn, & Croom, 2005, p. 61). Agricultural education programs can thrive or die in any community based

solely upon the ability of the program to offer current, desirable, high-quality educational experiences in an affordable manner (Talbert et al., 2005).

A recognizable source of secondary level education in agricultural sciences is the classroom. Agricultural classroom instruction is a foundational basis for activities taking place in the laboratory and outside environment (Phipps et al., 2008). Activities in the agricultural laboratory require students to use their newly-gained knowledge from the classroom instruction while developing psychomotor skills (Phipps et al., 2008).

The mechanical technologies of agriculture require students to apply new principles in an even greater dimension. Students must take elements which are a challenge to see or visualize, moving too fast or slow, in an effort to apply and understand the mechanical processes taking place (McGregor, 2002). These are abstract concepts rather than concrete in the students' minds (Gagné, 1985). It is the instructor's role to help the students understand the theoretical processes (i.e., small gasoline engines) before students can utilize them in the laboratory. Many approaches have been used to address the vague concepts of agricultural mechanization: still images, drawings, focused demonstrations and aids, engine cutaways, and actual parts; however, these tools fail to show students the realistic motion of such machines (McGregor, 2002).

Agricultural teachers need to take advantage of the strengths and interests of today's students by using technology to develop the most effective means of educating their students (Phipps et al., 2008). By showing students mechanic technologies in an action-oriented, digital form, students can be exposed to views that are unattainable through traditional methods. Teachers of agriculture must look past the skills needed for the jobs of yesterday and today and begin preparing students for the jobs of the future (Talbert et al., 2005). Because of the emersion students in today's society undergo with technology, incorporating it in the classroom should benefit knowledge acquisition. The incorporation of technology has proven this in many other fields. Can technology-enhanced instruction benefit students in agricultural education? The use of digital technologies has begun to take hold in agricultural education; however, the question remains unanswered towards the benefit of this movement when compared to proven previous practices used in agricultural education classrooms.

Theoretical Framework

The theory of constructivism has been examined by many researchers as the framework more currently suited for education and more specifically, agricultural education (Doolittle & Camp, 1999). Constructivism is defined as the act of learners creating an understanding through an experience (Fosnot, 1996). Dewey (1938) stressed his view that "sound educational experience involves, above all, continuity and interaction between the learner and what is learned" (p. 10). "...While reality may exist separate from experience, it can only be known through experience, resulting in a personally unique reality" (Doolittle & Camp, 1999, p. 4).

Cognitive constructivism serves as the type of constructivism by which this study was framed. According to cognitive constructivism, in order for learning to take place, the student must have an accurate real world experience that corresponds to an internal conceptualization. Instructional technology can play a role in creating a more student-centered learning environment through the experience gained in a constructivist approach (Simonson &

Thompson, 1997). This study examines the use of technology-enhanced instruction on student cognitive achievement as a means to provide the real world experience for abstract concepts that cannot always be seen or conceptualized first-hand in areas of mechanical technologies.

For centuries imagery has been used to influence memory and other cognitive processes. The Dual Coding Theory (DCT) was introduced by Allan Paivio as an approach to cognitive thinking, using both language (verbal) and imagery (nonverbal), in *Imagery and Verbal Processes* in 1971. It is a multimodal theory comprised of structures and representational components of words and things on the behavioral and perceptual level instead of abstractions of the words and items (Paivio, 2007). “The representations are connected to sensory input and response output systems as well as to each other so that they can function independently or cooperatively to mediate nonverbal and verbal behavior” (Paivio, 2007, p. 13). Figure 1 is a visual depiction of the DCT. Both verbal and nonverbal stimuli are connected through sensory systems on the visual, auditory, and haptic level (Paivio, 2007). “When information is dually coded, the probability of retrieval is increased because if one memory trace is lost, another is still available” (Rieber, 1991, p. 319). The DCT was supported by Su’s (2008) study results with the enhancement of student learning through multimedia.

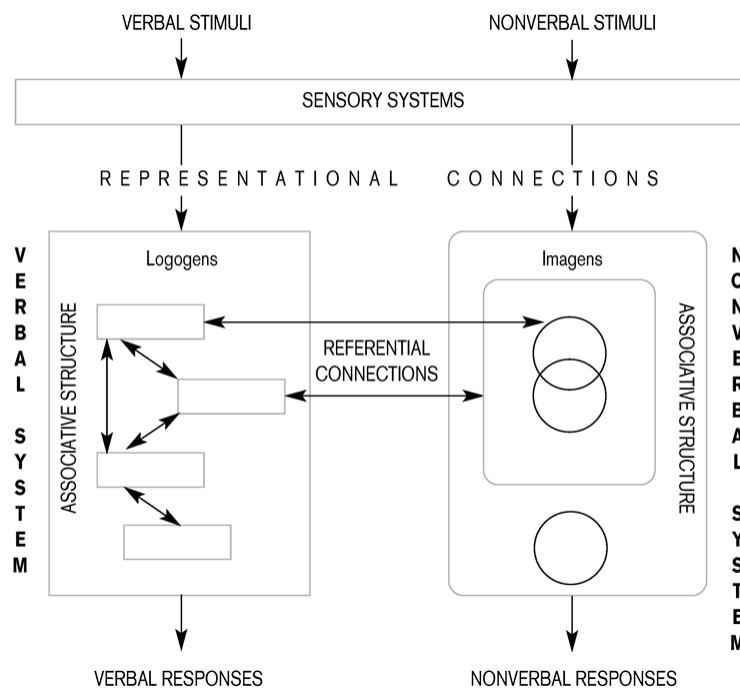

Figure 1. A dual coding model for adapting verbal and nonverbal information. Adapted from *Mind and Its Evolution: A Dual Coding Theoretical Approach*, Paivio, 2007.

With the influx of technologies in schools, many teachers fail to realize that technology should be used as a tool for enhancing instruction, rather than serve as the entire instruction, without guidance and direction from the teacher (Clark, 2008). Technologies in education can be both positive and negative, so how it is used, by whom, and for what purpose is key (Burbules &

Callister, 2000). Clark (2008) concluded that instructors still have a role in creating a positive instructional setting through constructivism; technology does not solely create one on its own.

Visualizations such as animations present opportunities for supportive scientific environments to be designed which can “stimulate learners to reconsider their prior knowledge” (Kali & Linn, 2008, p. 194). Animations help in the visualization of abstract concepts through concrete representations and events (Wouters, Pass, & van Merriënboer, 2008; McGregor, 2002; Su, 2008). They can be manipulated, distorted, and shaped to improve the visualization of a concept (Hegarty, 2004). Many actions that may take a long time to put together or facilitate can be shown successfully through animation in addition to a lecture in order to fill in the knowledge gap unanswered by static pictures (Larive, 2008). Increased student cognitive achievement when using animation over static images has been seen in many other studies covering a range of subject areas other than agriculture (Boucheix & Guignard, 2005; Höffler & Leutner, 2007; Su, 2008; Özmen, Demircioğlu, & Demircioğlu, 2009). Edgar (2006) expressed the challenge of teaching abstract concepts of agricultural mechanization all-inclusively using only pictures, diagrams, chalk boards, and verbal explanations. Technological forms of instruction, like animation, may offer students an increased understanding of mechanical powers and science principles in agriculture (Dooley, Stuessy, Magill, & Vasudevan, 2000; McGregor, 2002).

Teachers expressed their beliefs that increased use of educational technologies would pose great future benefits for their programs (Alston, Miller, & Williams, 2003). In a study analyzing agricultural power technology systems no significant differences were found in student achievement (McGregor, 2002). Conversely, students showed an increased level of understanding in verbal explanations to the researcher when animations were used in addition to the lecture in a study conducted by Edgar (2006). Students also vocalized support for the use of animations giving the researcher a sense of promise in aiding the future instruction of cognitive processes (Edgar, 2006).

Methodology

The purpose of this study was to determine if there was a significant difference ($p \leq .05$) in the cognitive achievement between students enrolled in Agricultural Science and Technology at the secondary level taught by technology-enhanced instruction compared with traditional lecture of four-stroke cycle small gasoline engines. In addition, this study looked to identify any differences in student perceptions of instruction, in gender specific achievement, in achievement based on time of day of the instruction, and in achievement based upon tinkering self-efficacy as measured via test instrumentation.

The following hypotheses were formulated to guide this study:

- Ho₁: There will be no significant difference in cognitive achievement between students taught by technology-enhanced instruction compared with traditional lecture in the principles of operation of four-stroke cycle small gasoline engines.
- Ho₂: There will be no significant difference in cognitive achievement between students taught by technology-enhanced instruction compared with traditional lecture in the principles of carburetion of four-stroke cycle small gasoline engines.

- Ho₃: There will be no significant difference in student perceptions between students taught by technology-enhanced instruction compared with traditional lecture in the principles of operation of four-stroke cycle small gasoline engines.
- Ho₄: There will be no significant difference in student perceptions between students taught by technology-enhanced instruction compared with traditional lecture in the principles of carburetion of four-stroke cycle small gasoline engines.
- Ho₅: There will be no significant difference in students' cognitive achievement based on gender, time of day of instruction, and/or tinkering self-efficacy between students taught by technology-enhanced instruction compared with traditional lecture in the principles of operation of four-stroke cycle small gasoline engines.
- Ho₆: There will be no significant difference in students' cognitive achievement based on gender, time of day of instruction, and/or tinkering self-efficacy between students taught by technology-enhanced instruction compared with traditional lecture in the principles of carburetion of four-stroke cycle small gasoline engines.

A quasi-experimental, modified counterbalanced design (#11) with internal replication from Campbell and Stanley (1963) was chosen for this study. Following Campbell and Stanley's (1963) outlining of a counterbalanced research design, Table 1 served as the design of this study.

Table 1

Modified Counterbalanced Research Design

Group	Pretest	Lesson 1	Posttest	Lesson 2	Posttest
1	O ₁	X _{C1}	O ₂	X _{T2}	O ₃
2	O ₁	X _{T1}	O ₂	X _{C2}	O ₃

Subjects were selected from two [state] public schools. Of these two schools, two intact classes of Agricultural Science and Technology were chosen from each school to participate in this study. This sample was chosen based upon the selected characteristic of attainable intact classes of students enrolled in agricultural science and technology. Generalizations from this study's results made outside of the subjects whom took part in the experiment should be cautioned (Oliver & Hinkle, 1982).

Each class was coded based on time of day of instruction. Of the four classes chosen, a total of 71 ($n = 71$) students completed the study. Two separate lessons on small gasoline engines were taught at each school. Of the two intact classes per school, one was randomly chosen to serve as the control for the first lesson with the other serving as the treatment group. The groups were exchanged for the second lesson, having each class serve as both a control and a treatment for separate lessons.

Students were given a pretest one week before the treatment was taught to measure their knowledge prior to the treatments and collect demographic data. The pretest consisted of 30 questions covering small gasoline engine theory, 15 from operation and 15 from carburetion, as

well as seven tinkering self-efficacy questions. The day following each lesson, an immediate posttest was administered. The posttest consisted of 15 questions addressing the lesson, as well as 20 Likert-style questions over student perceptions of the lesson.

The first lesson taught covered the principles of operation of four-stroke cycle small gasoline engines. The control group was taught the lesson content in the traditional lecture format. The experimental group was taught the same content, using PowerPoint® instead of the handout and white board. The researcher discussed the same principles while supporting his lesson with the technological-enhanced method of PowerPoint while also presenting animations and video of the engine operation components and theory. The second lesson taught covered principles of carburetion of four-stroke cycle small gasoline engines. The control group, which served as the experimental groups for the first lesson, was taught the lesson through traditional lecture. The experimental group, which served as the control group for the first lesson, was taught with the researcher using PowerPoint while also presenting animations and video of the engine carburetion components and theory.

The cognitive achievement instrument for the study was developed by the researcher. The student perceptions questions were adapted from an instrument by Silance and Remmers (1934) to fit each lesson. Twenty Likert-style questions were used ranging from 1 to 7. The tinkering self-efficacy questions were adapted from an instrument by Sallee (2010). It consisted of seven Likert-style questions. These questions sought to measure students' perceived ability of tinkering by requiring them to place themselves in a situation and answer each question as a result (Sallee, 2010). The instrument was reviewed for face and content validity using a panel of agricultural education and mechanization experts' familiar with instruction on the secondary level. Improvements were made to insure that the instrument could answer the hypotheses of this study. The instrument was pilot tested with a group of twenty-one students enrolled in Agricultural Science and Technology at a local [state] public school similar to the sample of study. Cronbach's Alpha was used to measure the instruments' consistency of subjects' answers for similar questions. The pretest resulted in a Cronbach's Alpha (α) value of .82 while the posttest obtained a value of .88. In testing reliability of the tinkering self-efficacy questions, Sallee (2010) reported $\alpha = .89$.

Data were organized and analyzed for each research hypotheses using SAS® 9.2 for Windows™ statistical package. Descriptive statistics were used to analyze the demographic variable data. Inferential statistics were used to analyze the instrument data for testing differences using independent *t*-tests. All data were also reexamined based on gender, time of day of instruction, and tinkering self-efficacy in order to reanalyze the group mean differences between the pretest and posttests from each lesson using the ANOVA procedure. Statistical power was also calculated for the instrument in order to detect the probability of detecting a meaningful difference if one truly did exist.

Findings

Demographics described for this study include gender, grade level, and time of day of instruction (AM/PM). Because all subjects served in both a control and treatment group, they will be represented as a whole sample. Of the original 94 students enrolled in classes that

participated in this study, 21 were removed from the data sample due to an absence on any one or more of the five days required for the study resulting in a usable sample size of 73 students. Two students were identified statistically through box plot analysis as outliers, removed from final data analysis, resulting in the final sample size ($n = 71$).

A majority of the participants' gender was recorded as male (90.14%) with the remaining indicating female (9.86%). Ninth graders comprised 78.87% of the sample, tenth graders 14.09%, eleventh graders 1.41%, and twelfth graders 5.63%. Subjects' time of day of instruction was similar with 54.93% of the sample being instructed in the AM and 45.07% of subjects receiving PM instruction.

Null hypothesis one stated that there would be no significant difference in cognitive achievement between students taught by technology-enhanced instruction compared with traditional lecture in the principles of operation of four-stroke cycle small gasoline engines. Mean scores for the pretest and posttest for both the traditional and technology-enhanced classes at both schools ($n = 71$). While the control groups at each school recorded pretest scores of 48.52 ($SD = 16.62$) and 37.95 ($SD = 13.71$), the treatment groups recorded scores of 41.40 ($SD = 19.45$) and 46.98 ($SD = 20.60$), respectively. Posttest scores for the control groups were 62.59 ($SD = 15.02$) and 54.36 ($SD = 13.57$) with the treatment groups recorded scores of 51.58 ($SD = 15.84$) and 58.41 ($SD = 17.88$). An independent t -test was used to test this hypothesis. Table 2 indicates no significant difference in cognitive achievement between the traditional and technology-enhanced classes of principles of operation scores, $t(69) = 1.12$; $p = .27$. The null hypothesis was held to be true.

Table 2

t-test for Cognitive Achievement in Principles of Operation ($n = 71$)

Instructional Method	<i>f</i>	<i>M</i>	<i>SD</i>	<i>t</i>	<i>p</i>
Traditional (C)	31	15.05 ¹	15.00	1.12	.27
Technology-Enhanced (T)	40	10.83 ¹	16.24		

Note. ¹ Derived from pretest score subtracted from posttest score.

Null hypothesis two stated that there will be no significant difference in cognitive achievement between students taught by technology-enhanced instruction compared with traditional lecture in the principles of carburetion of four-stroke cycle small gasoline engines. Mean scores for the pretest and posttest for both the traditional and technology-enhanced classes at both schools ($n = 71$). While the control groups at each school recorded pretest scores of 40.70 ($SD = 16.31$) and 38.09 ($SD = 12.32$), the treatment groups recorded scores of 44.07 ($SD = 20.98$) and 36.92 ($SD = 14.30$), respectively. Posttest scores for the control groups were 57.19 ($SD = 17.96$) and 67.94 ($SD = 20.18$) with the treatment groups recorded scores of 59.63 ($SD = 20.13$) and 59.49 ($SD = 20.99$). An independent t -test was used to test this hypothesis. Table 3 shows no significant difference in cognitive achievement between the traditional and technology-

enhanced classes of principles of carburetion scores, $t(69) = 1.09$; $p = .28$. This analysis resulted in the null hypothesis to be held true.

Table 3

t-test for Cognitive Achievement in Principles of Carburetion (n = 71)

Instructional Method	<i>n</i>	<i>M</i>	<i>SD</i>	<i>t</i>	<i>p</i>
Traditional (C)	40	23.50 ¹	20.14		
				1.09	.28
Technology-Enhanced(T)	31	18.50 ¹	18.03		

Note. ¹ Derived from pretest score subtracted from posttest score.

Null hypothesis three stated that there will be no significant difference in student perceptions between students taught by technology-enhanced instruction compared with traditional lecture in the principles of operation of four-stroke cycle small gasoline engines. The traditional groups recorded means of 3.01 ($SD = 1.03$) and 2.78 ($SD = 1.29$) with ranges from 1.35 to 5.65 while the technology-enhanced groups posted means of 2.96 ($SD = 1.21$) and 2.74 ($SD = 1.09$) with ranges from 1.05 to 6.30. An independent *t*-test revealed no significant (Table 4) difference between traditional lecture and technology-enhanced instruction perception scores in principles of operation, $t(69) = .25$; $p = .80$. The null hypothesis failed to be rejected.

Table 4

t-test for Student Perceptions in Principles of Operation (n = 71)

Instructional Method	<i>n</i>	<i>M</i>	<i>SD</i>	<i>t</i>	<i>p</i>
Traditional (C)	31	2.91 ¹	1.13		
				.25	.80
Technology-Enhanced(T)	40	2.84 ¹	1.14		

Note. Likert Scale of 1 to 7 with 1 representing *strongly agree* and 7 representing *strongly disagree*.

No significant difference in student perceptions between students taught by technology-enhanced instruction compared with traditional lecture in the principles of carburetion of four-stroke cycle small gasoline engines was the stated null hypothesis four. Perceptions were measured using a Likert Scale from 1 to 7: 1 = *strongly agree* to 7 = *strongly disagree*. The traditional groups recorded means of 3.47 ($SD = .96$) and 2.78 ($SD = 1.02$) with ranges from 1.55 to 5.90 while the technology-enhanced groups posted means of 2.93 ($SD = .50$) and 2.57 ($SD = 1.21$) with ranges from 1.45 to 5.95. This hypothesis was not found to be significant when analyzed using an independent *t*-test, $t(69) = 1.40$; $p = .17$. This finding resulted in the null hypothesis being held true (Table 5).

Table 5

t-test for Student Perceptions in Principles of Carburetion (n = 71)

Instructional Method	<i>n</i>	<i>M</i>	<i>SD</i>	<i>t</i>	<i>p</i>
Traditional (C)	40	3.11 ¹	1.04		
				1.40	.17
Technology-Enhanced(T)	31	2.78 ¹	0.87		

Note. Likert Scale of 1 to 7 with 1 representing *strongly agree* to 7 representing *strongly disagree*.

Null hypothesis five stated that there will be no significant difference in students' cognitive achievement based on gender, time of day of instruction, and/or tinkering self-efficacy between students taught by technology-enhanced instruction compared with traditional lecture in the principles of operation of four-stroke cycle small gasoline engines. An overall mean score of 4.14 (.70) was recorded for the classes with a range from 2.00 to 5.00. Mean tinkering self-efficacy scores for classes one through four were 3.97 ($SD = .81$), 4.11 ($SD = .86$), 4.08 ($SD = .57$), and 4.52 ($SD = .38$). Null hypothesis five was tested using a factorial Analysis of Variance (ANOVA) procedure. Table 6 reveals no significant difference in the cognitive achievement for principles of operation through the interaction of the main effects ($F = .96, p = .44$). Additionally, no significance was found through any of the main effects of gender ($F = .03, p = .86$), time of instruction ($F = .06, p = .81$), or tinkering self-efficacy ($F = .00, p = .99$).

Table 6

Cognitive Achievement Mean Comparison in Principles of Operation (n = 71)

Source	<i>df</i>	<i>SS</i>	<i>MS</i>	<i>F</i>	<i>p</i>
Model	7	998.08	142.58	.55	.79
Gender	1	8.41	8.41	.03	.86
Time of Instruction	1	15.10	15.10	.06	.81
Tinkering Self-Efficacy	1	.02	.02	.00	.99
Main Effect Interactions	4	996.93	249.23	.96	.44
Error	63	16347.41	259.48		
Total	70	17345.49			

Null hypothesis six stated that there will be no significant difference in students' cognitive achievement based on gender, time of day of instruction, and/or tinkering self-efficacy between students taught by technology-enhanced instruction compared with traditional lecture in the principles of carburetion of four-stroke cycle small gasoline engines. The ANOVA procedure

was used to test this hypothesis. Table 7 reveals no significant difference in the cognitive achievement for principles of carburetion through the interaction of the main effects ($F = .30$, $p = .87$). Additionally, no significance differences were found through any of the main effects of gender ($F = 2.94$, $p = .09$), time of instruction ($F = .23$, $p = .63$), or tinkering self-efficacy ($F = .08$, $p = .78$).

Table 7

Cognitive Achievement Mean Comparison in Principles of Carburetion (n = 71)

Source	<i>df</i>	<i>SS</i>	<i>MS</i>	<i>F</i>	<i>p</i>
Model	7	2205.77	315.11	.83	.56
Gender	1	1112.43	1112.43	2.94	.09
Time of Instruction	1	86.70	86.70	.23	.63
Tinkering Self-Efficacy	1	29.05	29.05	.08	.78
Main Effect Interactions	4	458.83	458.83	.30	.87
Error	63	23804.38	377.85		
Total	70	26010.15			

Conclusions, Discussion and Implications

Fosnot (1996) explained constructivism in learning as when learners create an understanding through an experience. Alston, Miller, and Williams (2003) strongly suggested that educational theory should guide any adoption of instructional technology within agricultural education. This study utilized technology, in verbal and nonverbal descriptions of the four-stroke cycle small gasoline engine, as a means of providing students with the accurate real world experience needed for developing an internal understanding set in DCT and cognitive constructivism. Although no significant differences were seen through this study, conclusions about the findings should be explored to further develop the answer towards animation being either a friend or foe to educators.

Given the setting in which this study was conducted, it is presumed that traditional lecture and technology-enhanced instruction served the participants equally well when learning principles of operation and carburetion of four-stroke cycle small gasoline engines. Although many people have called for the use of technology in education (Darling-Hammond & Bransford, 2005; National Research Council, 1988; Phipps et al., 2008), this study revealed that technology-enhanced instruction served no greater benefit at producing cognitive achievement than did traditional lecture for the lessons of principles of operation and carburetion of four-stroke cycle small gasoline engines. If in fact no significant difference actually exists (Type II error), the field of agricultural education should reexamine the push for technology-enhanced instruction in order to establish a better understanding of its advantages and disadvantages for

future recommendations. However, it is surmised based on the findings of this study that when students are exposed to mechanical concepts for the first time at a young age, they could be distracted by the animations and video contained within the PowerPoint® countering any possible positive effect of the technology. Additionally, the question arises towards the effective use of technology-enhanced instruction with first-time learners lacking any basic knowledge of the content presented in this study. The findings from hypotheses one and two add to the varying results involving technology-enhanced instruction in education.

With the weak calculated statistical powers of the design for measuring cognitive achievement for principles of operation and carburetion (.06 and .20), it is possible that a significant difference could truly exist but was not found in this study due to the small sample size, possibility of a Type II error being committed, strength of the instrument, and/or design of this study. If the study were to be replicated in the future, a larger sample size should be utilized, in addition to reexamining the instrument and design of the study, in order to maximize the difference between the independent variables, minimize the error, and control for extraneous variables at a higher level than previously attained.

These results mirror some others' results of no significant difference in cognitive achievement when various forms of technology-enhanced instructions in a range of educational areas, including post-secondary agriculture, were utilized (Daniels, 1999; Marrison & Frick, 1993; McGregor, 2002). However, the findings of the first two hypotheses are inconsistent with the results of previous studies which found a significant effect on student cognitive achievement through various forms of technology-enhanced instructions (Lowry, 1999; Mantei, 2000; Boucheix & Guignard, 2005; Höffler & Leutner, 2007; Özmen, et al., 2009; Su, 2008). This issue appears to be far from settled and deserves further study.

Clark (2008) stated that the innovative use of technology can increase interest and enthusiasm in the classroom. Technology may be the difference in restoring student interest from years of dull lectures (Gilroy, 1998). Both positive and negative results can arise from educational technologies; therefore, the who, what, and how surrounding the use of technologies is important (Burbles & Callister, 2000). No significant difference in student perceptions of the principles of operation lesson between traditional lecture and technology-enhanced instruction was evident. Student perceptions of the principles of carburetion lesson were also found to have no significant difference.

Furthermore, no significant difference between student perceptions among the control and treatment groups within each lesson; therefore, it is presumed that students view each type of instruction as equal means of instruction. The research posits, based on previous research (Edgar, 2006), if participants had been asked to qualitatively compare and contrast the traditional lecture and technology-enhanced instruction, more insight towards personal perceptions might occur and this should be further studied.

Results parallel Kask (2000) which found computer presentations having no significant effect on male cognitive achievement but disagree with Kask's (2000) finding on an impact of female cognitive achievement. It should be noted that females only represented less than 10 percent of the sample for this study, with all of those subjects originating from school 1.

Although Sallee (2010) found a significant correlation between tinkering self-efficacy and cognitive achievement with a similar sample, the results of this study did not coincide.

Implications and Recommendations

Agricultural education instructors have been urged to seek out and share technological materials in order to enhance student achievement (National Research Council, 1988). The survival of agricultural education programs rely heavily on their ability to supply current, desirable, high-quality educational experiences to the students of their respective communities (Talbert et al., 2005). According to Phipps et al. (2008), with the interests current students hold in technology, agricultural teachers should utilize technology in developing the most effective means of educating their students. The fundamental purpose of this study was to identify any differences between traditional lecture and technology-enhanced instruction in lessons of four-stroke cycle small gasoline engines.

The results of this study reveal no significant impact on student cognitive achievement or student perceptions of teaching methods when technology is adopted for instructional methods of principles of operation and carburetion of four-stroke cycle small gasoline engines. Both forms of instruction were positively perceived while the demographic characteristics of gender, time of instruction, and tinkering self-efficacy were found to hold no significant impact on cognitive achievement.

Although differences due to the primary independent variable were not found in this study possibly due to design limitations, future replications of this study should be done to determine if a significant difference actually exists between technology-enhanced instruction and traditional lecture at producing gains in student cognitive achievement. If differences were found the field of agricultural education could have a stronger foundational standing for implementing technology-enhanced instruction in the classroom. Such findings could impact the methods used in current and future classroom settings.

When replicating this study in the future, researchers should include larger samples to ensure a more uniform, representative sample is measured. Future studies should examine the implementation of more in-depth and/or expansive lessons with more specific instruments of varying difficulties. More expansive lessons would also allow the researcher to separately analyze low-level and high-level question achievement between traditional and technology-enhanced groups. Although the principles of operation and carburetion cognitive achievement instruments were composed of questions of various difficulties, data were not analyzed within these constructs. A qualitative approach to gathering student perceptions may reveal the subjects' detailed perceptions when comparing traditional lecture to technology-enhanced instruction. Consistent findings on student interest in technology-enhanced instruction help to govern teachers' investment of time and the educational finances required in supplying technology in the classroom.

REFERENCES

- Alston, A. J., Miller, W. W., & Williams, D. L. (2003). The future role of instructional technology in agricultural education in North Carolina and Virginia. *Journal of Agricultural Education, 44*(2), 38-49.
- Boucheix, J., & Guignard, H. (2005). What animated illustrations conditions can improve technical document comprehension in young students? Format, signaling and control of the presentation. *European Journal of Psychology of Education, 20*(4), 369-388.
- Burbules, N., & Callister, T., Jr. (2000). *Watch IT: The risks and promises of new information technologies for education*. Boulder, CO: Westview Press.
- Campbell, D. T., & Stanley, J. C. (1963). *Experimental and quasi-experimental designs for research*. Boston: Houghton Mifflin Company.
- Clark, J. (2008). PowerPoint and pedagogy: Maintaining student interest in university lectures. *College Teaching, 56* (1), 39-44.
- CARD. (1999). *The ABCs of tech prep*. Waco, TX: The Cornerstone of Tech Prep.
- Daniels, L. (1999). Introducing technology in the classroom: PowerPoint as a first step. *Journal of Computing Higher Education, 10*, 42-56.
- Darling-Hammond, L., & Bransford, J. (2005). *Preparing teachers for a changing world: What teachers should learn and be able to do*. San Francisco: Jossey-Bass.
- Dewey, J. (1938). *Experience & education*. New York: Touchstone.
- Dooley, K. E., Stuessy, C. L., Magill, J., Vasudevan, P. (2000). Cognitive and affective outcomes of animation on asynchronous learning of agricultural science concepts. *Proceedings of the 27th Annual National Agricultural Education Research Conference, 27*, San Diego, CA.
- Doolittle, P. E., & Camp, W. G. (1999). Constructivism: The career and technical education perspective [Electronic version]. *Journal of Vocational and Technical Education, 16*(1), 1-15.
- Edgar, D. (2006). The effects of computer-animated instruction upon understanding of high school students. *Proceedings of the 2006 Southern Region Conference of the American Association for Agricultural Education*, Orlando, FL.
- Fosnot, C. T. (1996). *Constructivism: Theory, perspective, and practice*. New York: Teachers College Press.

- Gilroy, M., & Princeton Univ., N. (1998). Using technology to revitalize the lecture: A model for the future. (ERIC Document Reproduction Service No. ED437123) Retrieved March 12, 2009, from ERIC database.
- Hegarty, M. (2004). Mechanical reasoning as mental simulation. *Trends in Cognitive Sciences*, 8, 280-285.
- Höffler, T. N., & Leutner, D. (2007). Instructional animation versus static pictures: A meta-analysis. *Learning and Instruction*, 17(6), 722-738.
- Kali, Y., & Linn, M.C. (2008). Designing effective visualizations for elementary school science. *The elementary school journal*, 109(2), 181-198.
- Kask, S. (2000, January). *The impact of using computer presentations (CAP) on student learning in the microeconomics principles course*. Paper presented at the meeting of the American Economic Association, Boston.
- Larive, C. K. (2008). A picture is worth a thousand words: Animations and simulations in the teaching of analytical science. *Anal Bioanal Chem*, 390, 71-75.
- Lowry, R. B. (1999). Electronic presentation of lectures – effect upon student performance. *University Chemistry Education*, 3, 18-21.
- Mantei, E. J. (2000). Using internet class notes and powerpoint in physical geology lecture: Comparing the success of computer technology with traditional teaching techniques. *Journal of College Science Teaching*, 29, 301-305.
- Marrison, D. L., & Frick, M. J. (1993). Computer multimedia instruction versus traditional instruction in post-secondary agricultural education. *Journal of Agricultural Education*, 34(4), 31-38.
- McGregor, K. W. (2002). *Effects of computer-animated instruction upon cognition of undergraduates in an agricultural power technology course*. Retrieved from ProQuest Digital Dissertations. (AAT 3069183)
- National Research Council. (1988). *Understanding agriculture: New directions for education*. Washington, D.C.: National Academy Press.
- Özmen, H., Demircioğlu, H., & Demircioğlu, G. (2009). The effects of conceptual change texts accompanied with animations on overcoming 11th grade students' alternative conceptions of chemical bonding. *Computers & Education*, 52(3), 681-695.
- Phipps, L. J., Osborne, E. W., Dyer, J. E., & Ball, A. (2008). *Handbook on agricultural education in public schools* (6th ed.). Clifton Park, NY: Thomson Delmar Learning.
- Prensky, M. (2001). Digital natives, digital immigrants. *On the Horizon*, 9(5), 1-6.

- Rieber, L. P. (1991). Animation, incidental learning, and continuing motivation. *Journal of Educational Psychology*, 83(3), 318-328.
- Sallee, C. W. (2010). *The effects of alternative fuel education program on knowledge acquisition in secondary agricultural settings*. Unpublished master's thesis, University of Arkansas.
- Simonson, M. R., & Thompson, A. (1997). *Educational computing foundations*. Upper Saddle River, NJ: Merrill.
- Su, K. (2008). An integrated science course designed with information communication technologies to enhance university students' learning performance. *Computers & Education*, 51(3), 1365-1374.
- Talbert, B. A., Vaughn, R., & Croom, D. B. (2005). *Foundations of agricultural education* (1st ed.). Catlin, IL: Professional Educators Publications.
- Wouters, P., Paas, F., & van Merriënboer, J. J. G. (2008). How to optimize learning from animated models: A review of guidelines based on cognitive load. *Review of Educational Research*, 78(3), 645-675.

Teachers' Use of Interactive Whiteboards in the Secondary Agricultural Education Classroom: Measures of Self-efficacy, Outcome Expectations, Interest and Selected Relationships

J.C. Bunch, Graduate Assistant
J. Shane Robinson, Assistant Professor
M. Craig Edwards, Professor

Oklahoma State University

Abstract

The purpose of this descriptive-correlational study was to examine the level of self-efficacy of Oklahoma secondary agricultural education teachers regarding their use of the interactive whiteboard (IWB) in classroom teaching. The study also sought to determine if relationships existed between teachers' IWB self-efficacy scores, outcome expectation scores, interest scores, and selected personal and professional characteristics. The findings of this study revealed that as age and years of teaching experience increased, levels of self-efficacy and outcome expectations decreased. Therefore, younger and less experienced teachers were more efficacious and had higher expectations regarding the use of IWBs. Further, this study showed that teachers who perceived they used IWBs more frequently demonstrated higher levels of self-efficacy and outcome expectation. Recommendations and implications point to the creation of professional development opportunities for "digital immigrant" teachers to learn how to use IWBs more effectively and engage students better. In addition, future research should examine how "digital native" teachers are using IWBs as well as other interactive technologies they may be using in their classrooms.

Introduction

"Here and across the country, the traditional chalkboards that have been teachers' primary tool for presenting content for more than two centuries are quickly being erased from classrooms" (Manzo, 2010, para. 3). This phenomenon is due partly to meet the needs of the digital generation (Manzo, 2010). Students of today have changed drastically and are not the students our current educational system was intended to teach (Oblinger, 2003; Prensky, 2001; Tapscott, 1998). Contemporary students spend numerous hours interacting with computers, cellular phones, MP3 players, and a variety of other technologies (Bennett, Maton, & Kervin 2008; Prensky, 2001). As a result of this digital environment, and the absolute quantity of student interaction with technologies, students think and process information differently than previous generations (Brown, 2000; Frand, 2000; Prensky, 2001; Tapscott, 1999).

Prensky (2001) identified these modern day students as *digital natives* because students are "native speakers" of the "language" of digital technologies. Moreover, technological advances unfamiliar to prior generations of learners are routine with today's "computer savvy" generation (Bunch, Haynes, Ramsey, Edwards, & Robertson, 2010). Digital natives perceive that the educational system has brought in "outsiders" to instruct them. These students speak a "different

language” than their pre-digital instructors (Prensky, 2001). Brown (2000) described this phenomenon as a shift in learning. He contributed this shift to differences in learning medium, i.e., Internet versus books. Digital natives have been engrossed with digital libraries and endless amounts of information via the Internet. As such, digital natives have also shifted from an authority-based learning style (i.e., behaviorist) to a more discovery-based learning style (i.e., constructivist) (Brown, 2000). Digital natives favor learning through investigation and trial. This is contrary to their pre-digital instructors who have a propensity to be authority-based. Prensky (2001) defined these “pre-digital instructors” as *digital immigrants*. A digital immigrant is someone who was not immersed in the digital world while growing up but has taken up using some aspects of digital technologies later in life.

As instructors who are digital immigrants confront the challenges that accompany “a newfangled” generation of students, they must reevaluate their approaches to instruction and recognize practices that are pertinent to today’s digital natives (McAlister, 2009). One new technology being used in today’s classrooms is the Interactive Whiteboard (IWB). Lewin, Somekh, and Steadman (2008) described IWBs as oversized, touch screen whiteboards coupled to a classroom computer, which allow teachers to access motionless and moving imagery accompanied by sound. IWBs offer a multi-media approach that addresses the needs of entire classes or individual learners, and are being used to challenge students to think by using an assortment of stimuli (i.e., audio, visual, and kinesthetic) (Glover, Miller, Averis, & Door, 2007).

Haldane (2007) noted that several interactivities were observed when teachers used IWBs. These interactivities included,

Verbal interpersonal [communication] between the pupils and their teacher; Visual interaction between the pupils and the pictorial symbols on the IWB; Cognitive interaction between the pictorial symbols on the IWB; Teacher interaction with the content (verbal and on the IWB) and the pupil responses; Interactions with the content via the technological facility of the medium zoom in, to move parts of a plant around, to illustrate points by introducing short animations showing how a shoot grows up and a root grows down. (p. 269)

To that end, Hodge and Anderson (2007) asserted that student engagement (interactivity) is a positive element of teachers using IWBs.

The use of IWBs in the agricultural education classroom, due to its potential for stimulating interactivity, can be associated with experiential learning. Rufus Stimson (1919) surmised that, “neither skill nor business ability can be learned from books alone, nor merely from observation of the work and management of others. Both require active participation during the learning period . . .” (p. 32). More recent, Roberts (2006) noted that experiential learning has been a hallmark of secondary agricultural education. So, can IWBs be used as a tool to enrich experiential learning in secondary agricultural education?

Few studies have examined how agricultural education teachers are incorporating technology into their pedagogical practices (Kotrlik, Redmann, & Douglas, 2003). Given that little research has been conducted on how teachers are using IWBs, especially in the agricultural education

classroom, a study examining agricultural education teachers' use of IWBs was warranted (Bunch, Whisenhunt, Edwards, Robinson, & Ramsey, 2010). In particular, studies to describe teachers' self-efficacy regarding their use of IWBs could add value to the scholarly literature with implications for teacher professional development.

Theoretical Framework

The theoretical framework undergirding this study was Bandura's (1977) self-efficacy theory. According to Bandura, two main influences on human behavior operate concurrently: an individual's personal characteristics and his or her environment. How the two interact independently with an individual's behavior, and with one another, influences a person's future behavior choices (Bandura, 1986). To change a behavior, the person needs to believe he or she is capable of performing the desired change and concomitant action (Bandura, 1989). Bandura referred to this concept as self-efficacy. Bandura (1993) noted that, efficacy influences the way in which individuals feel, think, are motivated, and behave. Further, Bandura (1997) asserted that perceived self-efficacy is an individual's belief in his or her ability to systematize and perform the sequence of actions necessary to complete a specific task or achieve a prescribed outcome.

Additionally, Bandura (1977) described the concept of outcome expectancy as a person's belief that a specific behavior will presage a definite outcome. Outcome expectations play a vital role in human motivation (Niederhauser & Perlunan, 2008). If individuals do not believe their actions will have the preferred outcomes, they will be less likely to perform those actions (Pajares, 2006). Further, outcome expectations could make an individual maintain behaviors over time if they perceive their actions will produce the preferred outcome ultimately (Niederhauser & Perkman, 2008).

Self-efficacy and outcome expectations have a prevailing influence on interest (Lent et al., 2005; Smith, 2002). Demonstrations of interest replicate "a person's patterns of likes, dislikes, and indifferences regarding . . . career relevant activities" (as cited in Niederhauser & Perkman, 2008, p. 101). According to Bandura (1986), people build interests in which they believe themselves to be self-efficacious and envision more positive outcomes. Likewise, in a study conducted by Fouad and Smith (1996), interest was a significant mechanism in career psychology, and a strong predictor of intentions.

Based on Bandura's self-efficacy theory, Tschannen-Moran, Hoy, and Hoy (1998) defined teacher self-efficacy as "the teacher's belief in his or her capability to organize and execute courses of action required to successfully accomplish a specific teaching task in a particular context" (p. 233). In addition, the combination of a teachers' perceptions of his or her teaching capability and beliefs about the task requirements contribute to teacher efficacy (Tschannen-Moran et al., 1998). Tschannen-Moran et al. also posited that higher levels of efficacy presages more effort and perseverance, resulting in higher efficacy levels, and lower efficacy foretells less effort and perseverance, leading to lower efficacy levels and poor teaching outcomes. This "fulfilling" or concomitant nature of self-efficacy in teaching also has been found in agricultural education (Knobloch, 2001; Roberts, Harlin, & Briers, 2008; Roberts, Harlin, & Ricketts, 2006; Stripling, Ricketts, Roberts, & Harlin, 2008; Whittington, McConnell, & Knobloch, 2006).

However, the amount of research featuring teacher self-efficacy and its relationship to teachers' use of educational technologies in agricultural education is limited.

Purpose and Objectives

The purpose of this descriptive-correlational study was to assess selected perceptions (i.e., level of self-efficacy, outcome expectation, and interest) of Oklahoma secondary agricultural education teachers regarding their use of the IWB in classroom teaching. The study also sought to determine if relationships existed between teachers' IWB self-efficacy scores, outcome expectation scores, interest scores, and selected personal and professional characteristics.

The following research objectives guided this study: 1) Describe selected personal and professional characteristics of Oklahoma agricultural education teachers, i.e., age, years of completed teaching experience, size of school where employed, access to IWBs, access to school-employed Information Technology (IT) personnel, and frequency of IWB use per week; 2) Describe Oklahoma agricultural education teachers' level of self-efficacy, outcome expectation, and interest regarding the use of IWBs; 3) Describe relationships between Oklahoma agricultural education teachers' self-efficacy, outcome expectation, and interest; 4) Describe selected relationships between Oklahoma agricultural education teachers' level of self-efficacy, outcome expectation, and interest with selected personal and professional characteristics.

Methods

The study presented here was descriptive and correlational; its target population consisted of Oklahoma secondary agricultural education teachers ($N = 437$) during the 2010-2011 academic year. The study's sample ($n = 205$) was selected randomly from the target population (Krejcie & Morgan, 1970). Data were collected through an Internet questionnaire using the Tailored Design Method developed by Dillman, Smyth, and Christian (2009). This process included four contacts by electronic mail during the fall semester of the 2010-2011 academic year. To address frame error, i.e., teachers no longer in the profession and teacher relocation, 18 participants were removed from the sample. In addition, 18 participants had unusable electronic mail addresses, resulting in their removal from the sample. As a result, the sample of 205 teachers was adjusted to an accessible sample of 169 teachers. Completed questionnaires were received from 81 of the 169 teachers for a 48% response rate.

Instrumentation

The Interpersonal Technology Integration Scale (ITIS) developed by Niederhauser and Perkmen (2008) was used in this study. The 21-item ITIS asked respondents to signify their level of agreement with each statement using a five-point, summated-rating scale: "1" = "strongly disagree," "2" = "disagree," "3" = "neutral," "4" = "agree," and "5" = "strongly agree." The ITIS consisted of three constructs: Self-Efficacy (SE) to determine teachers' confidence for using IWBs (six items); Outcome Expectation (OE) to determine teachers' expected benefits from using IWBs (nine items); and Interest (INT) to determine teachers' interest in using IWBs (six items).

The ITIS was adjusted to meet the objectives of this study. Items were combined into a single instrument which employed a five-point, summated-rating scale. Additionally, 18 professional and personal characteristics questions were added to describe the sample and make selected correlational analyses possible. The instrument was reviewed by a panel of four agricultural education experts at Oklahoma State University to establish content and face validity. Per the recommendations of the panel, minor revisions were made to the final instrument. The ITIS was then pilot-tested with 36 Oklahoma agricultural education teachers to determine reliability estimates by construct. Reliability analysis of the pilot instrument yielded acceptable Cronbach's alpha coefficients for the three constructs: SE = 0.93; OE = 0.91; INT = 0.89. The overall reliability estimate of the instrument was 0.73.

Data Analysis

The data collected were analyzed using SPSS® version 17.0 for Windows™. Responses were coded for computer analysis. Research objectives one and two were analyzed using descriptive statistics (i.e., frequencies, percentages, means, and standard deviations). Research objectives three and four were achieved by computing Spearman rho and Pearson Product-Moment Correlation Coefficients, where appropriate. According to Ary, Jacobs, and Razavieh (2002), Pearson *r* offers a significant index for demonstrating relationships. The strength of relationships was described using Davis' (1971) coefficient conventions: $.01 \geq r \geq .09$ = "Negligible," $.10 \geq r \geq .29$ = "Low," $.30 \geq r \geq .49$ = "Moderate," $.50 \geq r \geq .69$ = "Substantial," and $r \geq .70$ = "Very Strong."

To ensure that results were representative of the target population, an independent samples *t*-test was used to compare early and late respondents (Lindner, Murphy, & Briers, 2001). The first one-half of respondents, as determined by the date of return of the instrument, were considered "early" and the later one-half of respondents formed the "late" group. Level of significance was set at $p < .05$ *a priori*. No statistically significant differences were found between early and late respondents for constructs representing the study's dependent variables (i.e., SE, OE, and INT) (Table 1). So, assuming the late respondents were similar to non-respondents, the results of this study were deemed representative of the target population regarding the variables of interest.

Table 1

Comparison of Early and Late Respondents Regarding Oklahoma Agricultural Education Teachers' Levels of Self-Efficacy, Outcome Expectation, and Interest

Construct	Early Respondents		Late Respondents		<i>p</i> -value
	<i>M</i>	<i>SD</i>	<i>M</i>	<i>SD</i>	
Self-Efficacy	3.85	.65	3.68	.87	.32
Outcome Expectation	3.79	.70	3.68	.73	.49
Interest	3.81	.60	3.66	.76	.33

Note. The "real limits" of the scale were 1.00 to 1.49 = *strongly disagree*, 1.50 to 2.49 = *disagree*, 2.50 to 3.49 = *neutral*, 3.50 to 4.49 = *agree*, and 4.50 to 5.00 = *strongly agree*; $p < .05$

Findings/Results

Objective one sought to describe selected personal and professional characteristics of Oklahoma agricultural education teachers. Seventy-three (90%) of the participants were male, eight (6%) were female, and three (4%) failed to respond (Table 2). Five (6%) of the teachers were between 21 and 25 years of age, 18 (22%) of the respondents were between 26 and 30 years of age, 12 (15%) were between 31 and 35 years of age, and 14 (17%) were 51 years of age or older.

Regarding level of education attainment, a majority (70%) of the participants had earned only a bachelor's degree, 25% had earned a master's degree (Table 2). Concerning years of teaching experience, 21 (26%) of the respondents indicated they had between zero and five years of teaching experience, 14 (17%) had taught between 6 and 10 years, and 16 (20%) had taught between 11 and 15 years. Seventy-four teachers (91%) had received traditional teaching certification, and five (6%) indicated they had received their teaching certification via an alternative route. As for the size of school, most of the respondents indicated they were employed at either 1A schools (150 to 199 students), 2A schools (200 to 320 students), or B schools (86 to 149 students). The class size with the fewest respondents was class 5A (688 to 1242 students), where only two teachers (3%) reported being employed (Table 2).

In all, 59 (73%) participants indicated having access to IWBs. Thirty-three (41%) participants reported having "full access" to school-employed IT personnel, 30 (37%) indicated having access to school-employed IT personnel "sometimes," and 10 teachers (12%) had no access to school-employed IT personnel (Table 2).

Table 2

Selected Personal and Professional Characteristics of Oklahoma Agricultural Education Teachers (n = 81)

Variable	<i>f</i>	%
Age		
21 to 25 years	5	6.2
26 to 30 years	18	22.2
31 to 35 years	12	14.8
36 to 40 years	11	13.6
41 to 45 years	7	8.6
46 to 50 years	11	13.6
51 or older	14	17.3
No Response	3	3.7
Gender		
Male	73	90.1
Female	8	6.2
No Response	3	3.7
Highest level of educational attainment		
Bachelor's	57	70.4
Master's	20	24.7

Doctorate	1	1.2
No Response	2	2.5

Table 2 (Continued).

Selected Personal and Professional Characteristics of Oklahoma Agricultural Education Teachers (n = 81)

Variable	<i>f</i>	%
Years of teaching experience		
0 to 5 years	21	25.9
6 to 10 years	14	17.3
11 to 15 years	16	19.8
16 to 20 years	4	4.9
21 to 25 years	6	7.4
26 to 30 years	12	14.8
31 or more years	4	4.9
No Response	4	4.9
Teaching certification type		
Traditional	74	91.4
Alternative	5	6.2
No Response	2	2.5
School size		
Class C = < 86 students	4	4.9
Class B = 86 to 149 students	17	21.0
Class 1A = 150 to 199 students	18	22.2
Class 2A = 200 to 320 students	16	19.8
Class 3A = 321 to 482 students	7	8.6
Class 4A = 483 to 687 students	7	8.6
Class 5A = 688 to 1242 students	2	2.5
Class 6A = 1243 to 4461 students	8	9.9
No Response	2	2.5
Reported having access to IWBs	59	72.8
Reported having no access to IWBs	21	25.9
Reported having full access to school-employed IT	33	40.7
Reported having access to school-employed IT some of the time	30	37.0
Reported having no access to school-employed IT	10	12.3

Objective two sought to describe Oklahoma agricultural education teachers' level of self-efficacy, outcome expectation, and interest regarding the use of IWBs. Data are reported using summated means by item and construct (Table 3).

Table 3

Oklahoma Agricultural Education Teachers' Level of Self-Efficacy, Outcome Expectation, and Interest Regarding the Use of IWBs (n = 81)

Item	<i>M</i>	<i>SD</i>
Construct 1: Self-Efficacy		
I feel confident that I can regularly incorporate appropriate IWBs into my lessons to enhance student learning.	3.93	.83
I feel confident that I can teach relevant subject matter with appropriate use of IWBs.	3.90	.88
I feel confident that I can effectively use IWBs in my teaching.	3.89	.82
I feel confident that I can select appropriate IWBs for instruction based on curriculum standards-based pedagogy.	3.74	.95
I feel confident that I have the necessary skills to use IWBs for instruction.	3.62	.92
I feel confident that I can help students when they have difficulty with IWBs.	3.49	.94
Composite Mean	3.76	.76
Construct 2: Outcome Expectation		
Using IWBs in the classroom will increase my effectiveness as a teacher.	4.17	.83
Using IWBs in the classroom will make my teaching more exciting.	4.11	1.00
Using IWBs in the classroom will increase my productivity.	4.02	.88
Using IWBs in the classroom will make it easier for me to teach.	3.99	.92
Using IWBs in the classroom will make my teaching more satisfying.	3.93	.83
Effectively using IWBs in the classroom will increase my sense of accomplishment.	3.60	.90
Effectively using IWBs in the classroom will increase my colleagues' respect of my teaching ability.	3.30	.99
My colleagues will see me as competent if I effectively use IWBs in the classroom.	3.25	1.00
Effectively using IWBs in the classroom will increase my status among my colleagues.	3.23	.94
Composite Mean	3.73	.72
Construct 3: Interest		
I am interested in learning about new educational software.	4.11	.76
I am interested in working with IWB tools.	4.07	.70

Table 3 (continued).

Oklahoma Agricultural Education Teachers' Level of Self-Efficacy, Outcome Expectation, and Interest Regarding the Use of IWBs (n = 81)

Item	<i>M</i>	<i>SD</i>
I have an interest in attending IWB workshops during my teaching career.	3.88	.87
I have an interest in listening to a famous instructional technologist speaking about effective use of IWBs.	3.74	.95
I have an interest in working on a project involving IWB concepts.	3.47	.88
I have an interest in reading articles or books about IWBs.	3.16	.94
Composite Mean	3.74	.68

Note. The “real limits” of the scale were 1.00 to 1.49 = *strongly disagree*, 1.50 to 2.49 = *disagree*, 2.50 to 3.49 = *neutral*, 3.50 to 4.49 = *agree*, and 4.50 to 5.00 = *strongly agree*.

When self-efficacy items were analyzed, respondents “agreed” that they were confident incorporating IWBs appropriately into lessons to enhance student learning ($M = 3.93$, $SD = .83$), and they “agreed” they were confident teaching relevant subject matter with appropriate use of IWBs ($M = 3.90$, $SD = .88$) (Table 3). In addition, respondents “agreed” they could use IWBs effectively in their teaching ($M = 3.89$, $SD = .82$). Respondents reported having the lowest level of agreement in being confident about helping students when they have difficulties with IWBs ($M = 3.49$, $SD = .94$). In addition, responses to all self-efficacy items were summed and averaged to yield an overall self-efficacy score of 3.76 ($SD = .76$), indicating that teachers “agreed” to being self-efficacious at using IWBs (Table 3).

As for teachers’ levels of agreement regarding outcome expectation, respondents rated “using IWBs in the classroom will increase their effectiveness as a teacher” highest ($M = 4.17$, $SD = .83$) (Table 3). Teachers expressed the second highest level of agreement with the item “using IWBs in the classroom will make their teaching more exciting” ($M = 4.11$, $SD = 1.00$), and the third highest level of agreement was with the item “using IWBs in the classroom will increase my productivity” ($M = 4.02$, $SD = .88$). However, respondents were “neutral” regarding the item “effectively using IWBs in the classroom will increase their status among colleagues” ($M = 3.23$, $SD = .94$). Responses to all outcome expectation items were summed and averaged, which yielded an overall outcome expectation score of 3.73 ($SD = .72$), indicating the teachers “agreed” that using IWBs would result in the preferred learning outcome they intended to attain (Table 3).

Regarding interest, respondents’ highest levels of agreement were with the items “I am interested in learning about new educational software” ($M = 4.11$, $SD = .76$), and “I am interested in working with IWB tools” ($M = 4.07$, $SD = .70$) (Table 3). Respondents indicated they were least interested in the item “I have an interest in reading articles or books about IWBs” ($M = 3.16$, $SD = .94$). Responses to all interest items were summed and averaged, which yielded an overall interest score of 3.74 ($SD = .68$), indicating the teachers “agreed” that they were interested in using IWBs in their classroom teaching (Table 3).

Objective three sought to describe selected relationships between Oklahoma agricultural education teachers' self-efficacy, outcome expectation, and interest regarding the use of IWBs. Outcome expectation and interest were moderately and positively related ($r = .61$), and had the highest correlation coefficient for the associations measured (Table 4).

Table 4

Relationships^a between Teachers' Self-Efficacy, Outcome Expectation, and Interest Regarding Use of IWBs (n = 81)

Construct	Outcome Expectation	Interest
Self-efficacy	.54*	.26*
Outcome Expectation		.61*

Note. ^aPearson-Product Moment Correlation Coefficient; * $p < .05$

In addition, teachers' self-efficacy and outcome expectation regarding their use of IWBs was also moderately and positively related ($r = .54$). Teachers' self-efficacy and interest regarding IWB use revealed a low and positive relationship ($r = .26$) (Table 4).

Objective four sought to describe relationships between Oklahoma agricultural education teachers' level of self-efficacy, outcome expectation, and interest with selected personal and professional characteristics (i.e., age, years of completed teaching experience, size of school where employed, access to IWBs, access to school-employed IT personnel, and frequency of IWB use per week).

The analyses revealed that teacher age, years of teaching experience, and size of school all had an inverse relationship with the variables self-efficacy, outcome expectation, and interest (Table 5). However, only the relationships between age, years of teaching experience, self-efficacy, and outcome expectation were statistically significant ($p < .05$). Self-efficacy and outcome expectation had a low and negative relationship with teacher age ($r = -.29$). Self-efficacy ($r = -.26$) and outcome expectation ($r = -.24$) both demonstrated a negative and low relationship with a respondent's years of teaching experience (Table 5). Teachers who were younger and had fewer years of teaching experience perceived they were more efficacious regarding their use of IWBs and held a higher outcome expectation for that practice.

Table 5

Relationships^a between Oklahoma Teachers' Self-Efficacy, Outcome Expectation, Interest and Their Age, Years of Teaching Experience, and Size of School

Construct	Age	Year of Teaching Experience	Size of School
Self-Efficacy	-.29*	-.26*	-.11
Outcome Expectation	-.29*	-.24*	-.09
Interest	-.09	-.11	-.13

Note. ^aSpearman rho Correlation Coefficient; * $p < .05$

In addition, teacher self-efficacy was found to be moderately and positively related with their access to IWBs ($r = .32$), access to IT personnel ($r = .46$), and IWB use per week ($r = .42$) (Table 6). The variable outcome expectation had a low and positive relationship with teachers' access to IT personnel ($r = .25$) and their IWB use per week ($r = .23$). However, teacher interest was not related significantly with the variables measured. The variable self-efficacy and access to IT personnel revealed the strongest relationship ($r = .46$) (Table 6).

Table 6

Relationships^a between Oklahoma Teachers' Self-Efficacy, Outcome Expectation, Interest with Their Access to IWBs, Access to School-Employed IT Personnel, and Frequency of IWB Use per Week

Construct	Access to IWBs	Access to IT Personnel	IWB Use per Week
Self-Efficacy	.32*	.46*	.42*
Outcome Expectation	.16	.25*	.23*
Interest	-.06	-.02	.15

Note. ^aSpearman rho Correlation Coefficient; * $p < .05$

Conclusions

The most frequent age category reported by the respondents was 26 to 30 years of age. As such, it can be concluded that the teachers in this group were born between 1980 and 1984. According to Bennett, Maton, and Kervin (2008), individuals born during or after 1980 are considered digital natives who prefer to use digital technology. Of the 81 respondents involved in this study, more than 90% were male. This finding is consistent with the Oklahoma agricultural education teacher population (G. Shoulders, personal communications, September 22, 2010). A majority of teachers had taught between zero (i.e., a first year teacher) and 15 years, and 63% were employed at smaller, more rural schools, ranging from class C (< 86 students) to class 2A (200 to 320 students). Nearly, three-fourths of the respondents had access to IWBs, and almost 80% had access to school-employed IT personnel at least "sometimes" (Table 2).

This study revealed the responding teachers were confident using IWBs to teach and they perceived that IWBs enhanced student learning. In addition, the teachers indicated that IWBs made them more effective and their teaching more exciting. The findings also revealed teachers had an interest in learning about other educational technologies.

Only very small differences existed in the composite mean scores for the study's major constructs. The teachers "agreed" with the self-efficacy items ($M = 3.76$) regarding their use of IWBs. Teachers also "agreed" that IWBs would assist them in obtaining their outcome expectations regarding its use ($M = 3.73$). Finally, the teachers "agreed" they were interested in IWBs ($M = 3.74$).

The findings of this study suggest that as a teacher's age and years of teaching experience increased, his or her levels of self-efficacy and outcome expectation regarding IWB use

decreased. Therefore, younger and less experienced teachers were more efficacious and had higher expectations regarding their use of IWBs. This finding resonates with Prensky (2001) who claimed that most teachers, i.e., those who are older and more experienced, are digital immigrants and lack technological confidence. In addition, teachers who had access to IWBs agreed they were more efficacious because of opportunities to practice using the IWB. This finding is consistent with Bandura's (1977) self-efficacy theory, which posits the more an individual attempts a task, the more self-efficacious that person becomes regarding the behavior.

Further, this study showed that teachers who used IWBs more frequently perceived they held higher levels of self-efficacy and outcome expectation. This finding also supports research by Bandura (1989) who stated that to change a behavior (i.e., increased use of IWBs), an individual must believe he or she is capable of performing the task. Additionally, this finding supports research by Pajares (2006) who claimed that if an individual perceives his or her actions will result in the preferred outcome; he or she is more likely to perform said actions. It should be noted that teacher interest was not found to be related significantly with any of the selected personal and professional characteristics tested. This finding contradicts research by Lent et al. (2005) and Smith (2002) who stated that self-efficacy and outcome expectation is likely to influence an individual's interest significantly.

Discussion and Implications

In this study, teachers' age and years of teaching experience were negatively related to outcome expectation for using IWBs. Perhaps, veteran teachers (i.e., digital immigrants) are too established and "set in their ways" to adopt interactive technologies and, as such, fail to perceive the value of using IWBs in their classroom instruction. Further, it can be implied that because these veteran teachers are pre-digital (Prensky, 2001), it will take them longer to develop confidence in using IWBs, teaching with IWBs, and perceiving the relevance of IWBs, as indicated by their lower self-efficacy scores. Although the more experienced teachers did not use IWBs as frequently as less experienced teachers, Prensky (2001) noted digital immigrants use some aspects of digital technologies. The findings of this study supported Bandura's (1977) self-efficacy theory which posits the more an individual attempts a task the more self-efficacious that person becomes.

Further, according to Bandura (1986), people develop interest in tasks for which they believe themselves to be self-efficacious. However, this study did not support that contention: Why is that? Teachers indicated having the highest level of agreement in learning about new educational technologies. So, could it be that they have lost interest in using IWBs because new classroom technologies have been implemented? In addition, interest mirrors activities that an individual likes, dislikes, or is indifferent about according to Lent, Brown, and Hackett (as cited in Niederhauser & Perkman, 2008).

Recommendations for Practice

Professional development opportunities should be created for teachers to learn how to use IWBs effectively to engage students better. In addition, providers of professional development should consider delivering workshops or in-service sessions designed to meet the needs of the two

teacher groups: digital natives and digital immigrants. Opportunities should also exist in which digital native and digital immigrant teachers could be paired together to develop a Community of Practice (CoP) (Lave & Wenger, 1991), for example, a CoP devoted to learning about the use of IWBs and other instructional technologies. Teacher educators might consider using digital immigrants as cooperating teachers during the student teaching internship. Student teachers who are confident using IWBs could be placed purposefully with digital immigrant cooperators to create an environment where IWBs are used more frequently (Understandably, teacher educators must consider other important variables regarding a student teacher's placement, and in some cases, the fact that a potential cooperator may excel the intern in his or her instructional technology acumen).

Recommendations for Future Research

Future research should be conducted to determine which interactive technologies experienced and early-career teachers are using in their classrooms. This would provide insight on these teachers' needs regarding their use of instructional technologies. For example, are younger, less experienced teachers using IWBs in behavioral or constructivist ways (Brown, 2002)? In addition, future research should examine teachers' different types of interest more thoroughly in regard to an array of educational technologies, including IWBs. Finally, future inquires should be conducted to determine how the use of IWBs affects student learning and achievement in secondary agricultural education.

References

- Ary, D., Jacobs, L. C., & Razavieh, A. (2002). *Introduction to research in education*. Belmont, CA: Wadsworth/Thomson Learning.
- Bandura, A. (1977). Self-efficacy: Toward a unifying theory of behavioral change. *Psychological Review*, *84*, 191–215.
- Bandura, A. (1986). *Social foundations of thought and action: A social cognitive theory*. Englewood Cliffs, NJ: Prentice-Hall.
- Bandura, A. (1989). Human agency in social cognitive theory. *American Psychologist*, *44*, 1175–1184.
- Bandura, A. 1993. Perceived self-efficacy in cognitive development and functioning. *Educational Psychologist*, *28*(2), 117–148.
- Bandura, A. (1997). *Self-efficacy: The exercise of control*. New York, NY: W.H. Freeman and Company.
- Bennett, S., Maton, M., & Kervin, L. (2008). The 'digital natives' debate: A critical review of the evidence. *British Journal of Educational Technology*, *39*(5), 775–786. doi: 10.1111/j.1467-8535.2007.00793.x

- Brown, J. S. (2000). Growing up digital: How the web changes work, education, and the ways people learn. *United States Distance Learning Association Journal*, 16(2). Retrieved from http://www.usdla.org/html/journal/FEB02_Issue/article01.html
- Bunch, J. C., Whisenhunt, J. H., Edwards, M. C., Robinson, J. S., & Ramsey J. W. (2010). *Using interactive whiteboards in the agricultural education classroom: How student teachers are using this technology—Potential implications for teacher educators*. Poster presented at the 2010 AAAE Southern Education Research Conference, Orlando, FL. Abstract retrieved from http://aaaeonline.org/uploads/allconferences/2-5-2010_130_Final_Proceedings.pdf
- Bunch, J. C., Whisenhunt, J. H., Ramsey J. W., Edwards, M. C., & Robertson, T. (2010). *Making learning meaningful for the millennials: Podcasting with a purpose in agricultural education*. Poster presented at the 2010 AAAE Western Education Research Conference, Great Falls, MT. Abstract retrieved from http://aaaeonline.org/uploads/allconferences/4-1-2010_796_2010_WR_AAAE_Poster_Proceedings2.pdf
- Davis, J. A. (1971). *Elementary survey analysis*. Englewood Cliffs, NJ: Prentice-Hall.
- Dillman, D. A., Smyth, J. D., & Christian, L. M. (2009). *Internet, mail, and mixed-mode surveys: The tailored design method*. Hoboken, NJ: John Wiley & Sons, Inc.
- Fouad, N. A., & Smith, P. L. (1996). A test of a social cognitive model for middle school students: Math and science. *Journal of Counseling Psychology*, 43(3), 338–346.
- Frاند, J. (2000). The information-age mindset: Changes in students and implications for higher education. *EDUCAUSE Review*, 35, September-October, 14–24.
- Glover, D., Miller, D., Averis, D., & Door, V. (2007). The evolution of an effective pedagogy for teachers using the interactive whiteboard in mathematics and modern languages: An empirical analysis from the secondary sector. *Learning, Media and Technology*, 32(1), 5–20. doi: 10.1080/17439880601141146
- Haldane, H. (2007). Interactivity and the digital whiteboard: Weaving the fabric of learning. *Learning, Media and Technology*, 32(3), 257–270. doi: 10.1080/17439880701511107
- Hodge, S., & Anderson, B. (2007). Teaching and learning with an interactive whiteboard: A teacher's journey. *Learning, Media and Technology*, 32(3), 271–282. doi: 10.1080/17439880701511123
- Knobloch, N. A. (2001). The influence of peer teaching and early field experience on teaching efficacy beliefs of preservice educators in agriculture. *Proceedings of the 28th Annual National Agricultural Educational Research Conference*, 28, 119-131.

- Kotrlik, J. W., Redmann, D. H., & Douglas, B. B. (2003). Technology integration by agriscience teachers in the teaching/learning process. *Journal of Agricultural Education*, 44(3), 78–90.
- Krejcie, R. V., & Morgan, D. W. (1970). Determining sample size for research activities. *Educational and Psychological Measurement*, 30, 607–610.
- Lave, J., & Wenger, E. (1991). *Situated learning: Legitimate peripheral participation*. New York, NY: Cambridge Press.
- Lent, R. W., Brown, S. D., Sheu, H., Schmidt, J., Brenner, B. R., Gloster, C. S., . . . Treistman, D. (2005). Social cognitive predictors of academic interests and goals in engineering: Utility for woman and students at historically black universities. *Journal of Counseling Psychology*, 52(1), 84–92.
- Lewin, C., Somekh, B., & Steadman, S. (2008). Embedding interactive whiteboards in teaching and learning: The process of change in pedagogic practice. *Education Information Technology*, 13, 291-303. doi: 10.1007/s10639-008-9070-z
- Lindner, J. R., Murphy, T. H., & Briers, G. E. (2001). Handling nonresponse in social science research. *Journal of Agricultural Education*, 42(4), 43–53. doi: 10.5032/jae.2001.0443
- Manzo, K. (2010). Whiteboards' impact on teaching seen as uneven *Beyond Teacher Chalk Talk: Education Week's Digital Directions*. Retrieved from <http://www.edweek.org/dd/articles/2010/01/08/02whiteboards.h03.html>
- McAlister, A. (2009). Teaching the millennial generation. *American Music Teacher*, 59(1), 13–15. Retrieved from <http://search.ebscohost.com.ezproxy.osu-uls.okstate.edu/login.aspx?direct=true&db=aph&AN=43802552&site=ehost-live>
- Niederhauser, D. S., & Perkman, S. (2008). Validation of the intrapersonal technology scale: Assessing the influence of intrapersonal factors that influence technology integration. *Computers in the Schools*, 25(1), 98–111. doi: 10.1080/07380560802157956
- Oblinger, D. (2003). Boomers, Gen-Xers and Millennials: Understanding the new students. *EDUCAUSE Review*, 38, 4, July/August, 37–47.
- Pajares, F. (2006). *Overview of social cognitive theory and of self-efficacy*. Retrieved from <http://www.des.emory.edu/mfp/eff.html>
- Prensky, M. (2001). Digital natives, digital immigrants. *NCB University Press*, 9(5), 1–6.
- Roberts, T. G. (2006). A philosophical examination of experiential learning theory for agricultural educators. *Journal of Agricultural Education*, 47(1), 17–29. doi: 10.5032/jae.2006.01017

- Roberts, T. G., Harlin, J. F., & Briers, G. E. (2008). Peer modeling and teaching efficacy: The influence of two student teachers at the same time. *Journal of Agricultural Education*, 49(2), 13-26. doi: 10.5032/jae.2008.02013
- Roberts, T. G., Harlin, J. F., & Ricketts, J. C. (2006). A longitudinal examination of teaching efficacy of agricultural science student teachers. *Journal of Agricultural Education*, 47(2), 81-92. doi: 10.5032/jae.2006.02081
- Smith, S. M. (2002). Using the social cognitive model to explain vocational interest in information technology. *Information Technology, Learning, and Performance*, 20(1), 1-9.
- Stimson, R. W. (1919). *Vocational agricultural education by home projects*. New York, NY: MacMillan.
- Stripling, C., Ricketts, J. C., Roberts, T. G., & Harlin, J. F. (2008). Preservice agricultural education teachers' sense of teaching self-efficacy. *Journal of Agricultural Education*, 49(4), 120-130. doi: 10.5032/jae.2008.04120
- Tapscott, D. (1998). *Growing up digital: The rise of the Net generation*. New York, NY: McGraw-Hill.
- Tapscott, D. (1999). Educating the Net generation. *Educational Leadership*, 56(5), 6-11.
- Tschannen-Moran, M., Woolfolk Hoy, A., & Hoy, W. K. (1998). Teacher efficacy: Its meaning and measure. *Review of Educational Research*, 68(2), 202-248.
- Whittington, M. S., McConnell, E., & Knobloch, N. A. (2006). Teacher efficacy of novice teachers in agricultural education in Ohio at the end of the school year. *Journal of Agricultural Education*, 47(4), 26-38. doi: 10.5032/jae.2006.04026

Florida Preservice Agricultural Education Teachers' Mathematics Ability and Efficacy

Christopher T. Stripling, Graduate Assistant
T. Grady Roberts, Associate Professor
University of Florida

The purpose of this study was to examine the mathematics ability and efficacy of Florida preservice agricultural education teachers. The target population for this descriptive study was preservice agriculture teachers in Florida. The accessible population or sample was a census of the preservice teachers (n = 25) in their final year of the agricultural education program at the main campus of the University of Florida. Results indicated that the preservice teachers were not proficient in solving agricultural related mathematics problems. On the other hand, the preservice teachers were very efficacious in personal teaching efficacy and personal mathematics efficacy, and moderately efficacious in their mathematics teaching efficacy. Additionally, the associations between mathematics ability and mathematics coursework suggest that preservice teachers that completed an advanced mathematics course in high school and/or college scored higher on the mathematics assessment than preservice teachers that completed a basic or intermediate mathematics course in high school and/or college. However, only a small percentage of the preservice teachers completed an advanced mathematics course in high school and/or college. Based on the data collected in this study, the teacher education program at the University of Florida may need to further evaluate its mathematics coursework requirements.

Introduction

Why are 66% of Florida 9th grade students experiencing little to partial success in mathematics (Florida Department of Education, 2010)? Additionally, why do 35% of college freshmen at two year public institutions and 16% at four year public institutions participate in remedial mathematics courses (National Center for Educational Statistics, 2004)? During the past decade, the lack of mathematics proficiency among Florida students is well documented (Florida Department of Education, 2010), and according to the Michigan State University Center for Research in Mathematics and Science Education (2010), a lack of mathematics proficiency has created a troubling cycle in which teachers that are not proficient in mathematics are producing students with mathematical deficiencies, who then become the next generation of mathematics deficient teachers.

However, the solution may not fall just on mathematics teachers. To that end, Shinn et al. (2003) called for the agricultural education profession to embrace the role of improving mathematics achievement of secondary students. Before Shinn et al.'s call, the National Research Council (1988) called for secondary agricultural education to become more than vocational agriculture, to prepare students for careers that require competencies in science and mathematics, and to help students to effectively use new technologies. The National Research Council also posited that "teacher preparation and in-service education programs must be revised and expanded to develop more competent teachers" (p. 6-7). Similarly, Jansen and Thompson (2008) called for a "closer examination of [preservice agricultural teacher education] program requirements related to the level of mathematics exposure and proficiency in mathematics" (p.

26). Jansen and Thompson also purported that “as agricultural education becomes a viable avenue for increasing the rigor and relevance of core-academic connections, pre-service teaching requirements in mathematics may need to be increased to meet the demands of interdisciplinary instruction” (p. 26).

Based on the aforementioned findings, the fundamental problem this study investigated is the lack of mathematics success among Florida’s secondary students and potentially, Florida’s preservice agricultural teachers. It is possible, and perhaps probable that Florida’s preservice agriculture teachers may be ill prepared to effectively teach agricultural mathematics concepts. This study will examine this issue.

Theoretical Framework

Dunkin and Biddle’s (1974) model for the study of classroom teaching, which is based on the original work of Mitzel (1960), was used to frame this study. The aforementioned authors differentiate between four categories of variable: presage, context, process, and product. Dunkin and Biddle theorized that presage and context variables have a causative relationship with process variables and process variables have a causative relationship with product variables (Figure 1).

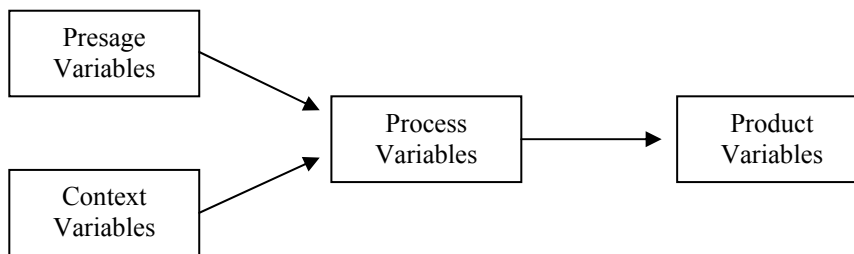

Figure 1. Adapted model for the study of classroom teaching.

According to Dunkin and Biddle (1974), presage variables “concern the characteristics of teachers that may be examined for their effects on the teaching process—thus, teacher formative experiences, teacher-training experiences, and teacher properties” (p. 39). Context variables are “characteristics of the environment about which teachers, school administrators, and teacher-educators can do very little” (p. 41). Examples of context variables are community, school, and classroom contexts, student populations, student formative experiences, and school and classroom budgets. Process variables are “the actual activities of classroom teaching— what teachers and pupils do in the classroom” (p. 44), and the interaction of teacher and student classroom behaviors yield observable positive or negative changes in a student’s academic learning. Changes in student learning that result from the interaction of the student with classroom activities, the teachers, and other students comprise the final category of variables, product variables.

Furthermore, Dunkin and Biddle (1974) purported that decisions made by teacher education programs concerning the “relationship between presage conditions and teaching processes” (p. 49) should be based on evidence. With that in mind, this study focused on the following presage variables of preservice agricultural education teachers: mathematical ability,

mathematics teaching efficacy, personal mathematics efficacy, and personal teaching efficacy (Figure 2).

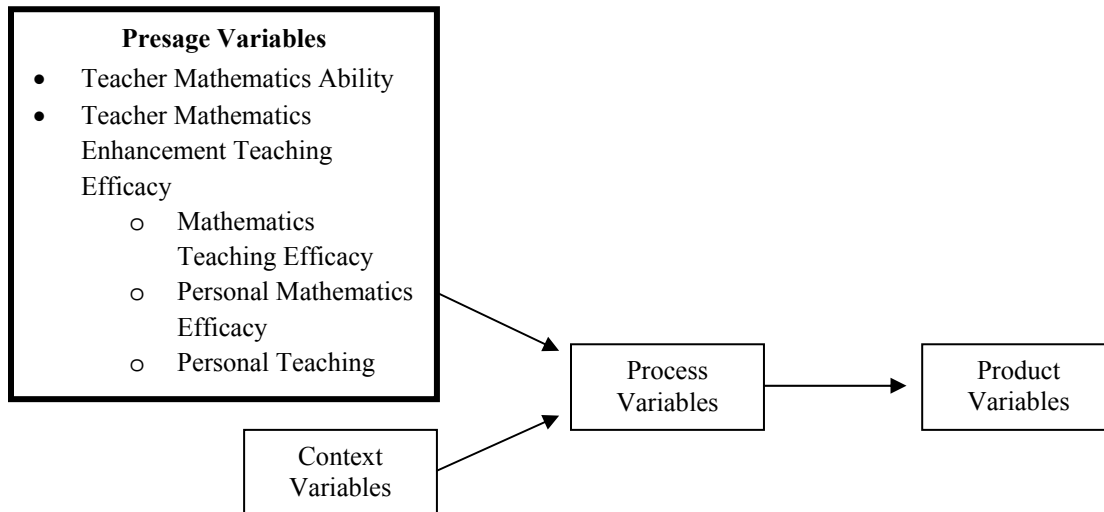

Figure 2. Conceptual framework of presage variables under investigation.

Literature Review

Agricultural Educators' Mathematics Ability

A comprehensive literature search revealed only a few studies that investigated the mathematical ability of agricultural education teachers or preservice teachers. Miller and Gliem (1994) sought to explain the variance in the mathematical ability of agricultural education teachers. A 15 item mathematical problem-solving test was developed by the researchers to test mathematical problem solving ability. The highest level of mathematics needed to solve the problems on the instrument was algebra. Based on the mean score of 66.47%, Miller and Gliem concluded that the teachers in the study were not proficient in solving agriculturally related mathematical problems. Additionally, the researchers reported that the relationships between mathematical problem-solving ability and the following variables were not significant: age and highest level of college mathematics coursework completed. However, the relationships between mathematical problem-solving ability, and years of teaching experience, final college grade point average, ACT math score and attitude toward including mathematics concepts in the curriculum and instruction of secondary agriculture programs were significant.

A similar study was conducted by Miller and Gliem (1996), but the participants in the study consisted of 49 preservice agricultural education teachers from The Ohio State University. The study used the same instrument as Miller and Gliem (1994), and the range of scores was 0% to 87.8%. Miller and Gliem reported that the preservice teachers averaged 37% and that 87.8% of the preservice teachers scored lower than 60%. Grade point average, level of mathematics courses taken, and gender were found to have negligible relationships with mathematical problem solving ability. A moderate relationship was found between mathematics ability and the number of mathematics courses completed. A substantial positive relationship was found between mathematics ability and ACT math score. Miller and Gliem also reported that preservice teachers with higher scores had completed advanced mathematics courses, completed a fewer number of mathematics courses, and possessed higher ACT math scores. The

researchers concluded that the “preservice agriculture educators were not capable of applying basic mathematics skills to agricultural problems” (p. 19).

Before Miller and Gliem (1994, 1996), Persinger and Gliem (1987) investigated the mathematical ability of secondary agriculture teachers and their students. The sample consisted of 54 teachers and 656 students. The agriculture teachers mean score on the 20 question mathematics ability test was 61.75%. The researchers reported that 28% of the teachers solved 50% or less of the problems correctly. Students of the mathematics deficient teachers were also shown to not be competent in mathematics, which supports the findings of Michigan State University Center for Research in Mathematics and Science Education (2010). The average score for the secondary students was 28%. Persinger and Gliem also reported that 82% of the students scored lower than 50%, and that the teacher’s test score was significantly related to the scores of their students.

Agricultural Educators’ Mathematics Enhancement Teaching Efficacy

Mathematics enhancement teaching efficacy is defined by the following three constructs: mathematics teaching efficacy, personal mathematics efficacy, and personal teaching efficacy (Jansen, 2007). Personal teaching efficacy or teacher efficacy is the “belief that one can bring about desired outcomes in one’s student” (Soodak & Podell, 1996, p. 401). According to Tschannen-Moran, Woolfolk Hoy, and Hoy (1998), “teacher efficacy is the teacher’s belief in his or her capability to organize and execute courses of action required to successfully accomplish a specific teaching task in a particular context” (p. 233). Guskey and Passaro (1994) defined teacher efficacy as a teacher’s belief in their ability to have an effect on student learning for all types of students. Moreover, teachers with high teaching efficacy exert more effort in planning and organization (Allinder, 1994) and persevere through challenges and undesired results (Goddard, Hoy, & Woolfolk Hoy, 2004). According to Tschannen-Moran et al. (1998), teacher efficacy is cyclical in nature with either a positive or negative effect.

Greater efficacy leads to greater effort and persistence, which leads to better performance, which in turn leads to greater efficacy. The reverse is also true. Lower efficacy leads to less effort and giving up easily, which leads to poor teaching outcomes, which then produce decreased efficacy. Thus, a teaching performance that was accomplished with a level of effort and persistence influenced by the performer’s sense of efficacy, when completed, becomes the past and a source of future efficacy beliefs. (p. 234)

Once teaching efficacy beliefs stabilize, they are difficult to change (Bandura, 1997; Tschannen-Moran et al., 1998). Bandura (1993) stated, “teachers’ beliefs in their personal efficacy to motivate and promote learning affect the types of learning environments they create and the level of academic progress their students achieve” (p. 1).

Furthermore, there is a plethora of recent research in agricultural education investigating teaching efficacy. Knobloch (2006) compared student teachers from the University of Illinois and The Ohio State University and reported that students at each institution were similarly efficacious, and their teacher efficacy did not change from the beginning to the end of the student teaching experience. Furthering the research of Knobloch (2006), Roberts, Harlin, and Ricketts (2006) examined the teaching efficacy of 33 preservice agricultural education teachers from Texas A&M University at different points during the student teaching experience. Roberts et al.

reported that a general trend emerged from the data for all three constructs (student engagement, instructional strategies, and classroom management) and overall teaching efficacy. The scores “increased during the four week block, then decreased by the mid-point of the student teaching experience, and finally increased again by the conclusion of the experience” (p 89). Harlin, Roberts, Briers, Mowen, and Edgar (2007) replicated the study conducted by Roberts et al. (2006) with a sample consisting of 99 preservice agricultural education teachers from the following four institutions: Tarleton State University, Texas A&M University, Texas Tech University, and Oklahoma State University. Consistent with Roberts et al. (2006), the data of Harlin et al. (2007) revealed the same general aforementioned trend.

Stripling, Ricketts, Roberts, and Harlin (2008) extended the research of Roberts et al. (2006) and Harlin et al. (2007) to include examining the impact of the teaching methods course on teaching efficacy. Data were collected for two years at the University of Georgia and Texas A&M University, and the sample consisted of 102 preservice agricultural education teachers. The overall teaching efficacy mean increased at each of the following data collection points: before the teaching methods course, after-the-methods course/before student teaching, and after-student-teaching. Likewise, the instructional strategies, student engagement, and classroom management scores increased at each data collection point. Stripling et al. reported that a significant difference existed for mean student engagement and classroom management scores over time and the effect sizes were medium. Significant differences were also reported for the mean instructional strategies scores over time and the effect size was large. Post hoc analysis revealed a significant difference for student engagement from before the methods course to after the methods course/before student teaching. Stripling et al. also reported a significant difference between the instructional strategies score from before the methods course and after the methods course/before student teaching. The classroom management scores did not reveal a significant difference except for the aforementioned classroom management overall teaching efficacy score.

Research that specifically investigates the mathematics teaching efficacy and mathematics efficacy of secondary and preservice agricultural education teachers is limited. Jansen and Thompson (2008) investigated the teacher efficacy beliefs that Oregon and Washington secondary agricultural teachers have toward enhancing mathematics in their curricula and reported that the participants in the study perceived themselves as very efficacious in personal mathematics (3.72 on a 4-point scale) and teaching ability (7.30 on a 9 point scale). The teachers were also very confident with teaching mathematics (3.71 on a 5 point scale). Jansen and Thompson purported that “content knowledge specifically related to mathematics seems to have a greater influence on mathematics teaching than pedagogical techniques and strategies...[and this] should influence the selection of programming for future professional development activities aimed to enhance mathematics in agricultural education lessons” (p. 26).

Similarly, Swan, Moore, and Echevarria (2008) sought to assess the confidence of Idaho agricultural mechanics teachers ($n = 54$) “in their own mathematics skills and their ability to teach mathematics skills” (p. 29). The researchers reported that

Basic College Mathematics was the only course in which the respondents indicated they had complete confidence to pass with an A or B. Respondents had much confidence to pass 11 of the courses listed, some confidence to pass 3 of the courses, and very little confidence to pass Advanced Calculus with a grade of A or B (p. 35).

However, the participants indicated that “they had complete confidence in their own ability to complete mathematics related tasks” (p. 36). The mean score was 8.21 ($SD = .82$) on a confidence scale of 0-9 from no confidence to complete confidence. Using the same confidence scale, Swan et al. found that the mean score in their ability to teach mathematics was 8.09 ($SD = .64$), which indicated that the agriculture mechanics teachers were completely confident in their ability to teach mathematics found within agricultural mechanics courses. Swan et al. also reported that a strong relationship ($r = .72$) was found “between teacher’s confidence in their own mathematic skills and their confidence to teach mathematic skills” (p. 38).

Secondary Mathematics Integration

The mathematics integration literature specific to agricultural education is limited. However, several studies have been conducted to test the effectiveness of a seven step model for enhancing mathematics in career and technical education curricula, known as the Math-in-CTE model (Stone, Alfeld, Pearson, Lewis, & Jensen, 2006), on various product variables (Dunkin & Biddle, 1974).

In a study of 38 secondary agricultural classes, Parr, Edwards, and Leising (2006) sought to determine if students that participated in a contextualized, mathematics-enhanced high school agricultural power and technology curriculum and aligned instructional approach would develop a deeper and more sustained understanding of selected mathematical concepts than students who participated in the traditional curriculum, thus resulting in less need for postsecondary mathematics remediation (p. 84).

Results indicated that students who took part in the math-enhanced curriculum were less likely to need postsecondary remediation. The practical significance of the finding was reported to be a large effect. In a similar study published in 2008, Parr, Edwards, and Leising investigated if students in a math-enhanced agricultural power and technology course would differ significantly from students in a traditional agricultural power and technology course in their technical skill acquisition. The findings revealed no significant difference, thus the math-enhanced agriculture power and technology curriculum did not lessen technical skills. In a third study investigating the effects of a math-enhanced agricultural power and technology curriculum, Parr, Edwards, and Leising (2009) did not find a significant difference in the mathematics ability of the secondary students. Parr et al. (2009) hypothesized that this may have been due to the fact “of incomplete implementation of the treatment as reported by some experimental teachers coupled with an intervention time frame of only one semester” (p. 1).

The Young, Edwards, and Leising (2008, 2009) inquiries were very similar to the studies of Parr et al.(2006, 2008, 2009). Young et al. (2008) sought to determine if mathematics enhanced agricultural power and technology curriculum would significantly increase the mathematical ability of the participants compared to a traditional mathematics agricultural power and technology curriculum. The study consisted of 32 Oklahoma high school classes, but the results did not show a significant statistical difference in mathematics ability between the experimental and control groups. However, the results revealed practical significance. In 2009, Young et al. published a second study that mirrored Parr et al. (2008). However, this investigation was a one year analysis versus a semester long analysis. The results also mirrored

the results of Parr et al. (2008) in which technical competence was not diminished by the mathematics enhanced curriculum.

Purpose and Objectives

The purpose of this study was to examine the mathematical ability, mathematics teaching efficacy, personal mathematics efficacy, and personal teaching efficacy of preservice agricultural teachers during the final year of an agricultural education program at the University of Florida. The following objectives framed this study:

1. Determine the highest category of mathematics completed in high school and college by preservice teachers at the University of Florida.
2. Describe the mathematics ability of preservice teachers at the University of Florida.
3. Describe the mathematics teaching efficacy, personal mathematics efficacy, and personal teaching efficacy of preservice teachers at the University of Florida.
4. Determine the magnitudes of the associations between mathematics ability of University of Florida preservice teachers and the type of mathematics the preservice teachers completed in high school and college.

Methods and Procedures

Research Design and Sample

The research design of this study was a one shot case study (Campbell & Stanley, 1963). The target population for this descriptive study was preservice agriculture teachers in Florida. For this study, the accessible population was a census of the preservice teachers in their final year of the agricultural education program at the main campus of the University of Florida. This purposive convenience sample was conceptualized as a slice in time (Oliver & Hinkle, 1981). Gall, Borg, and Gall (1996) stated that convenience sampling is appropriate as long as the researcher provides a detailed description of the sample used and the reasons for selection.

Thus, the purposive sample was selected because of the need to assess the mathematics ability and mathematics teaching efficacy of Florida preservice agricultural education teachers. The sample consisted of 25 preservice agricultural education teachers, 19 females and 6 males. The average age of the sample was 22 years old ($SD = 1.41$) with a range of 20 to 27. Twenty-three of the participants described their ethnicity as white, one as African American, and one as other. The majority of the participants were seniors in an undergraduate program ($n = 23, 92\%$), and the remaining two students were completing a graduate program. Twenty-three participants provided their college grade point average, and the mean GPA was 3.54 ($SD = 0.44$) on a 4-point scale. The number of college level mathematics courses completed by the participants ranged from 1 to 6 with a mean of 3.08 ($SD = 1.17$). The timing when the participants took their last math course ranged from the previous semester to 6 years ago. In their last math course, 39.1% received an A, 8.7% a B+, 26.1% a B, 4.3% a B-, 17.4% a C, and 4.3% a D.

Instrumentation

Participants consented to take the *Mathematics Ability Test* and the *Mathematics Enhancement Teaching Efficacy Instrument* (Jansen, 2007) by signing an informed consent approved by the University of Florida's IRB, and the instruments were administered during the

Fall 2010 teaching methods course. The teaching methods students were asked to complete the instruments during instructional time. To avoid coercion, participants were informed that participation in the study would not have an impact on their course grades.

The *Mathematics Ability Test* is a researcher-developed instrument and took approximately 45 to 60 minutes to complete. Face and content validity of the instrument was established by a panel of experts consisting of agricultural education faculty and mathematics faculty from three universities and two secondary mathematics experts. The reliability of the instrument was assessed using Cronbach’s alpha coefficient, and the alpha coefficient was found to be .80. In addition, one scorer was utilized to score the *Mathematics Ability Test*, and items were scored incorrect, partially correct (students set the problem up correctly but made a calculation error), and correct. Furthermore, the scorer used a rubric that was developed by two secondary mathematics experts to score each item. The *Mathematics Ability Test* was developed based on the 13 National Council of Teachers of Mathematics (NCTM) sub-standards (Carpenter & Gorg, 2000) that are cross-referenced with the National Agriculture, Food and Natural Resources Career Cluster Content Standards (National Council for Agricultural Education, 2009). Shinn (2003) hypothesized “that the integration of curricular materials that meet state and national standards, including NCTM Curriculum and Evaluation Standards for School Mathematics, into an agricultural education curriculum will result in higher student achievement in mathematics” (p. 29). The 13 cross-referenced NCTM sub-standards and the corresponding content or process area are provided in Table 1.

Table 1
Cross-referenced NCTM Sub-standards for Grades 9-12

Content/Process Area	NCTM Sub-standards
Number & Operations	1A. Understand numbers, ways of representing numbers, relationships among numbers, and number systems. 1B. Understand meanings of operations and how they relate to one another. 1C. Compute fluently and make reasonable estimates.
Algebra	2C. Use mathematical models to represent and understand quantitative relationships. 2D. Analyze change in various contexts.
Geometry	3A. Analyze characteristics and properties of two- and three dimensional geometric shapes and develop mathematical arguments about geometric relationships.
Measurement	4A. Understand measurable attributes of objects and the units, systems, and processes of measurement. 4B. Apply appropriate techniques, tools, and formulas to determine measurements.
Data Analysis & Probability	5A. Formulate questions that can be addressed with data and collect, organize, and display relevant data to answer them. 5B. Select and use appropriate statistical methods to analyze data. 5C. Develop and evaluate inferences and predictions that are based on data.
Problem Solving	6B. Solve problems that arise in mathematics in other contexts. 6C. Apply and adapt a variety of appropriate strategies to solve problems.

The *Mathematics Enhancement Teaching Efficacy Instrument* (Jansen, 2007) was developed and validated during a doctoral dissertation at Oregon State University and is divided into the following three constructs: mathematics teaching efficacy, personal mathematics efficacy, and personal teaching efficacy. Scores for each construct were calculated by averaging the corresponding items after reverse coding items 2, 4, 5, 7, 9, 10, 11, and 13. Jansen reported that face and content validity was established by a panel of experts. Jansen stated that the Cronbach's alpha coefficients for the mathematics teaching efficacy, personal mathematics efficacy, and personal teaching efficacy constructs to be .88, .84, and .91, respectively. The *Mathematics Enhancement Teaching Efficacy Instrument* took approximately 8-12 minutes to complete.

Data Analysis

Descriptive statistics were used to summarize demographics, mathematics teaching efficacy, personal mathematics efficacy, personal teaching efficacy, and mathematics ability of the preservice agricultural education teachers. Point Biserial correlation coefficients were used to determine the magnitude of the associations between mathematics ability and types of courses completed in high school and college. Also, Point Biserial correlation coefficients were used because the types of mathematics courses were coded as not completed (0) or completed (1). The types of mathematics courses completed in high school and college by the preservice agricultural teachers were categorized into basic, intermediate, and advanced mathematics by a mathematics expert. The mathematics expert categorized algebra, algebra II, and college algebra as basic mathematics, trigonometry, pre-calculus, and statistics as intermediate mathematics, and calculus as advanced mathematics. Also, the following terms were operationally defined for this study:

- *Mathematics ability* is defined as the students' scores on the *Mathematics Ability Test*.
- *Personal mathematics efficacy* is a person's self beliefs about their capabilities to solve mathematics problems. Personal mathematics efficacy was defined as the student's score on 8 items contained in the *Mathematics Enhancement Teaching Efficacy Instrument* by Jansen (2007).
- *Mathematics teaching efficacy* is a person's self belief about their capabilities to teach mathematics. Mathematics teaching efficacy was defined as the student's score on 13 items contained in the *Mathematics Enhancement Teaching Efficacy Instrument* by Jansen (2007).
- *Personal teaching efficacy* is a person's self belief about their capabilities to teach. Personal teaching efficacy was defined as the student's score on 12 items contained in the *Mathematics Enhancement Teaching Efficacy Instrument* by Jansen (2007).

Findings

Objective 1. Determine the Highest Category of Mathematics Completed in High School and College by Preservice Teachers at the University of Florida

Results revealed that preservice teachers most commonly completed an intermediate mathematics course as their highest level of mathematics in high school (45.8%) and college (58.3%) (Table 2). A basic mathematics course was completed as the highest level of mathematics by 33.3% in high school and 25% in college. An advanced mathematics course was completed as the highest level of mathematics by 20.8% in high school and 16.7% in college.

Table 2

Highest Category of Mathematics Courses Completed by the Preservice Agricultural Teachers

Type	<i>f</i>	Percent
<i>High School Mathematics Courses Completed</i>		
Basic High School	8	33.3
Intermediate High School	11	45.8
Advanced High School	5	20.8
<i>College Mathematics Courses Completed</i>		
Basic College	6	25.0
Intermediate College	14	58.3
Advanced College	4	16.7

Note. $n = 24$. One participant did not provide the mathematics course data.

Objective 2. Describe the Mathematics Ability of Preservice Teachers at the University of Florida

The preservice agricultural education teachers' scores on the 26 item *Mathematics Ability Test* ranged from 2.5 (9.6%) to 16.5 (63.5%), and a majority of the students (80%) answered less than 50% of the problems correctly. The mean number of correct responses was 9.26 ($SD = 3.74$) or 35.6%. Table 3 shows the distribution of scores on the *Mathematics Ability Test*.

Table 3

Preservice Agricultural Teachers' Scores on the Mathematics Ability Test

Score Range	Percent Correct Range	Frequency	Percentage of Students
2.5 to 5.0	9.6 to 19.2	5	20
6.0 to 9.0	23.1 to 34.6	9	36
9.5 to 12.5	36.5 to 48.1	6	24
13.0 to 16.5	50.0 to 63.5	5	20

Note. Mean Score 9.26 ($SD = 3.74$), out of 26 possible.

Objective 3. Describe the Mathematics Teaching Efficacy, Personal Mathematics Efficacy, and Personal Teaching Efficacy of Preservice Teachers at the University of Florida

As depicted in Table 4, the preservice teachers in this study were confident in their personal mathematics efficacy ($M = 3.45$, $SD = .28$). The preservice teachers also perceived themselves as having "Quite a Bit" of influence in affecting student learning (personal teaching efficacy $M = 7.35$, $SD = .43$). In addition, the preservice teachers were moderately efficacious in their mathematics teaching efficacy ($M = 3.32$, $SD = .55$).

Table 4

Means for Scales of the Mathematics Enhancement Teaching Efficacy Instrument

Measurement	<i>M</i>	<i>SD</i>	Scale
Personal Mathematics Efficacy (PME)	3.45	.28	1 = Not Confident to 4 = Very Confident
Mathematics Teaching Efficacy (MTE)	3.32	.55	1 = Strongly Disagree to 5 = Strongly Agree
Personal Teaching Efficacy (PTE)	7.35	.43	1 = Nothing to 9 = A Great Deal

Note. $n = 24$. One participant did not provide the mathematics course data.

Objective 4. Determine the Magnitudes of the Associations Between Mathematics Ability of University of Florida Preservice Teachers and the Type of Mathematics the Preservice Teachers Completed in High School and College

As seen in Table 5, moderate correlations were discovered between mathematics ability and basic high school mathematics ($r = -.43$), advanced high school mathematics ($r = .47$), basic college mathematics ($r = -.46$), and advanced college mathematics ($r = .40$). A low correlation was observed between mathematics ability and intermediate college mathematics ($r = .10$) and a negligible correlation was observed between mathematics ability and intermediate high school mathematics ($r = .03$). The magnitudes of the correlations were described using guidelines from Davis (1971).

Table 5

Point Biserial Correlations Between Highest Math Course Completed and Math Ability

	Basic High School	Intermediate High School	Advanced High School	Basic College	Intermediate College	Advanced College
Math Ability	-.43	.03	.47	-.46	.10	.40

Note. Mathematics level variables were coded as 0 = not highest type of mathematics completed; 1 = highest type of mathematics completed

Conclusions

Objective one sought to determine the highest category of mathematics completed in high school and college by preservice teachers at the University of Florida. More preservice teachers completed an intermediate mathematics course as their highest level of mathematics than basic or advanced mathematics in high school and/or college, which was consistent with Miller and Gliem (1996). Additionally, only a small percentage of the preservice teachers completed an advanced mathematics course in high school and/or college. Objective two sought to describe the mathematics ability of preservice teachers at the University of Florida. The preservice teachers were not proficient in solving agricultural related mathematics problems that were based on the 13 cross-referenced NCTM sub-standards, and this lack of proficiency was also consistent with Miller and Gliem (1996). Objective three sought to describe the mathematics teaching efficacy, personal mathematics efficacy, and personal teaching efficacy of preservice teachers at the University of Florida. The preservice teachers were very efficacious in personal teaching efficacy and personal mathematics efficacy, and moderately efficacious in their mathematics

teaching efficacy, thus mirroring the results of Jansen and Thompson (2008). Objective four sought to determine the magnitude of association between mathematics ability of University of Florida preservice teachers and the type of mathematics the preservice teachers completed in high school and college. The associations between mathematics ability and mathematics coursework suggest that preservice teachers that completed an advanced mathematics course in high school and/or college scored higher on the mathematics assessment than preservice teachers that completed a basic or intermediate mathematics course in high school and/or college, which supports Miller and Gliem (1996).

Recommendations and Implications

Based on the results of this study, there is a disconnect between preservice agricultural education teachers' mathematics ability and mathematics efficacy. The *Mathematics Ability Test* revealed that preservice teachers were not proficient in a substantial number of high school mathematics competencies. Yet, the preservice teachers in this study felt competent in their mathematics ability and efficacy. Bandura's (1986) social cognitive theory and Bandura's (1997) self-efficacy theory posited that personal factors influence behavior. So, in this case, mathematics ability and mathematics teaching efficacy should impact a teacher's ability to teach mathematics. If preservice teachers have low ability, why are they efficacious about teaching mathematics? Future research should seek to explain this disconnect between mathematics ability and efficacy. Furthermore, why do preservice teachers have such low mathematics ability? This is troubling since Dunkin and Biddle (1974) theorized that presage variables (e.g. teacher mathematics ability) influence process variables or classroom activities which affect product variables or student achievement. Therefore, future research should seek to determine factors that can improve the mathematics ability of preservice teachers.

To that end, the moderate association found between mathematics ability and advanced mathematics coursework may suggest that the teacher education program at the University of Florida should evaluate its mathematics coursework requirements. To meet the minimum requirements at the University of Florida a preservice teacher could complete college algebra and an introductory statistics course. Based on the data collected in this study, a majority of the students are not exceeding the minimum requirements. In addition, it is interesting to note that a portion of the preservice teachers had not completed a mathematics course since their freshman year of college. Furthermore, if high school mathematics and agricultural standards require secondary students to develop competencies beyond basic mathematics, it would seem reasonable to expect preservice teachers to complete higher levels of mathematics. What is more, how can one expect preservice teachers to teach higher level mathematics that are embedded in the high school agriscience curricula, when they are not proficient in high school mathematics or completing higher level mathematics coursework in college?

That being said, is the agricultural education profession willing to require preservice teachers to complete higher levels of mathematics? If the agricultural education profession is not willing to require preservice teachers to complete higher levels of mathematics, the profession may need to reconsider the mathematics requirements for our secondary agricultural

education students. However, lowering the mathematics requirements for secondary students would prevent the profession from answering the numerous calls for agricultural education to support core academic coursework and from welcoming the role of improving mathematics competences of secondary students. Based on the aforementioned implications and literature review, future research should seek to determine the amount of variance in mathematics ability that can be explained by the level of mathematics coursework in college. Additionally, future research should build upon the results of this study and seek to determine the mathematics ability and efficacy of the nation's preservice agricultural education teachers. Moreover, future research should seek to develop an intervention to increase the mathematics ability and efficacy of preservice agricultural education teachers. What is more, there is a gap in the literature on the extent to which secondary agricultural education teachers are providing instruction on mathematics concepts or the cross-referenced NCTM sub-standards. Future research should seek to fill the aforementioned gap.

References

- Allinder, R. M. (1994). The relationship between efficacy and the instructional practices of special education teachers and consultants. *Teacher Education and Special Education, 17*, 86-95.
- Bandura, A. (1986). *Social foundations of thought and action: A social cognitive theory*. Englewood Cliffs, NJ: Prentice Hall.
- Bandura, A. (1993). Perceived self-efficacy in cognitive development and functioning. *Educational Psychologist, 28*(2), 117-148.
- Bandura, A. (1997). *Self-efficacy: The exercise of control*. New York, NY: Freeman.
- Campbell, D. T., & Stanley, J. C. (1963). *Experimental and quasi-experimental designs for research*. Boston, MA: Houghton Mifflin.
- Carpenter, J., & Gorg, S. (Eds.). (2000). *Principles and standards for school mathematics*. Reston, VA: The National Council of Teachers of Mathematics.
- Davis, J. A. (1971). *Elementary survey analysis*. Englewood, NJ: Prentice-Hall.
- Dunkin, M. J., & Biddle, B. J. (1974). *The study of teaching*. Washington, D.C.: University Press of America.
- Florida Department of Education. (2010). Mathematics scores statewide comparison for 2001 to 2010. Retrieved from <http://fcats.fldoe.org/mediapacket/2010/pdf/2010MathComparison.pdf>
- Gall, M. D., Borg, W. R., & Gall, J. P. (1996). *Educational research: An introduction* (6th ed.). New York, NY: Longman.

- Goddard, R. D., Hoy, W. K., & Woolfolk Hoy A. (2004). Collective efficacy beliefs: Theoretical developments, empirical evidence, and future directions. *Educational Researchers*, 33(3), 3-13.
- Gusky, T. R., & Passaro, P.D. (1994). Teacher efficacy: A study of construct dimensions. *American Educational Research Journal*, 31, 627-643.
- Harlin, J. F., Roberts, T. G., Briers, G. E., Mowen, D. L., & Edgar, D. W. (2007). A longitudinal examination of teaching efficacy of agricultural science student teachers at four different institutions. *Journal of Agricultural Education*, 48(3), 78-90. doi: 10.5032/jae.2007.03078
- Jansen, D. J. (2007). *Validation of an instrument for mathematics teaching efficacy of pacific northwest agricultural educators* (Doctoral dissertation). Retrieved from <http://ir.library.oregonstate.edu/jspui/handle/1957/7689>
- Jansen, D. J., & Thompson, G. W. (2008). Pacific Northwest Agricultural Educators' Perceived Teacher Efficacy toward Enhancing Mathematics. *Proceedings of the 2008 Western Region American Association of Agricultural Educators Research Conference*, 27, 16-28. Retrieved from <http://aaaeonline.org/uploads/allconferences/35902008Proceedings.pdf>
- Knobloch, N. A. (2006). Exploring relationships of teachers' sense of efficacy in two student teaching programs. *Journal of Agricultural Education*, 47(2), 36-47. doi: 10.5032/jae.2006.02036
- Michigan State University Center for Research in Mathematics and Science Education. (2010). *Breaking the cycle: An international comparison of U. S. mathematics teacher preparation*. Retrieved from <http://www.educ.msu.edu/content/sites/usteds/documents/Breaking-the-Cycle.pdf>
- Miller, G., & Gliem, J. A. (1994). Agricultural education teachers' ability to solve agriculturally related mathematics problems. *Journal of Agricultural Education*, 35(4), 25-30. doi: 10.5032/jae.1994.04025
- Miller, G., & Gliem, J. A. (1996). Preservice agricultural educators' ability to solve agriculturally related mathematics problems. *Journal of Agricultural Education*, 37(1), 15-21. doi: 10.5032/jae.1996.01015
- Mitzel, H. E. (1960). Teacher effectiveness. In C. E. Harris (Ed.), *Encyclopedia of Educational Research* (3rd ed.). New York, NY: Macmillan.
- National Center for Education Statistics. (2004). *The condition of education 2004* (NCES 2004-077). Retrieved from <http://nces.ed.gov/programs/coe/>

- National Council for Agricultural Education. (2009). *National agriculture, food and natural resource career cluster content standards*. Retrieved from <http://www.teamaged.org/council/>
- National Research Council. (1988) *Understanding agriculture: New directions for Education*. Washington, D.C: National Academy Press.
- Oliver, J. D., & Hinkle, D. E. (1981, December). *Selecting statistical procedures for agricultural education research*. Paper presented at the 8th Annual National Agricultural Education Research Meeting, Atlanta, GA.
- Parr, B. A., Edwards, M. C., & Leising, J. G. (2006). Effects of a math-enhanced curriculum and instructional approach on the mathematics achievement of agricultural power and technology students: An experimental study. *Journal of Agricultural Education*, 47(3), 81-93. doi: 10.5032/jae.2006.03081
- Parr, B. A., Edwards, M. C., & Leising, J. G. (2008). Does a curriculum integration intervention to improve the mathematics achievement of students diminish their acquisition of technical competence? An experimental study in agricultural mechanics. *Journal of Agricultural Education*, 49(1), 61-71. doi: 10.5032/jae.2008.01061
- Parr, B. A., Edwards, M. C., & Leising, J. G. (2009). Selected effects of a curriculum integration intervention on the mathematics performance of secondary students enrolled in an agricultural power and technology course: An experimental study. *Journal of Agricultural Education*, 50(1), 57-69. doi: 10.5032/jae.2009.01057
- Persinger, K. M., & Gliem, J. A. (1987). Mathematical problem-solving skills of high school vocational agriculture teachers and students (ERIC No. 289975). Proceedings of the 14th Annual National Agricultural Education Research Meeting, 14, 200-207. Retrieved from <http://www.eric.ed.gov/ERICWebPortal/contentdelivery/servlet/ERICServlet?accno=ED289975>
- Roberts, T. G., Harlin, J. F., & Ricketts, J. C. (2006). A longitudinal examination of teaching efficacy of agricultural science student teachers. *Journal of Agricultural Education*, 47(2), 81-92. doi: 10.5032/jae.2006.02081
- Shinn, G. C., Briers, G. E., Christiansen, J. E., Edwards, M. C., Harlin, J. F., Lawver, D. E., Lindner, J. R., Murphy, T. H., & Parr, B.A. (2003). *Improving student achievement in mathematics: An important role for secondary agricultural education in the 21st Century*. Unpublished manuscript. Texas A&M University. College Station, TX
- Soodak, L. C., & Podell, D. (1996). Teacher efficacy: Toward the understanding of a multi-faceted construct. *Teaching and Teacher Education*, 12(4), 401-411.

- Stripling, C., Ricketts, J. C., Roberts, T. G., & Harlin, J. F. (2008). Preservice agricultural education teachers' sense of teaching self-efficacy. *Journal of Agricultural Education*, 49(4), 120-130. doi: 10.5032/jae.2008.04120
- Stone, J. R. III, Alfeld, C., Pearson, D., Lewis, M. V., & Jensen, S. (2006). *Building academic skills in context: Testing the value of enhance math learning in CTE*. Retrieved from <http://136.165.122.102/UserFiles/File/Math-in-CTE/MathLearningFinalStudy.pdf>
- Swan, B. G., Moore, L.L., & Echevarria, C. J. (2008). The Relationship of Agricultural Mechanics Teachers' Confidence in their Mathematic Skills and Confidence in their Ability to Teach Mathematic Skills. *Proceedings of the 2008 Western Region American Association of Agricultural Educators Research Conference*, 27, 29-41. Retrieved from <http://aaaeonline.org/uploads/allconferences/35902008Proceedings.pdf>
- Tschannen-Moran, M., Woolfolk Hoy, A., & Hoy K.W. (1998). *Teacher efficacy: Its meaning and measure*. *Review of Educational Research*, 68, 202-248.
- Young, R. B., Edwards, M. C., & Leising, J. G. (2008). Effects of a math enhanced curriculum and instructional approach on students' achievement in mathematics: A year-long experimental study in agricultural power and technology. *Journal of Southern Agricultural Education Research*, 58(1), 4-17.
- Young, R. B., Edwards, M. C., & Leising, J. G. (2009). Does a math-enhanced curriculum and instructional approach diminish students' attainment of teaching skills? A year-long experimental study in agricultural power and technology. *Journal of Agricultural Education*, 50(1), 116-126. doi: 10.5032/jae.2009.01116

Determining the Effect of a Science-Enhanced Curriculum on Agricultural Content Knowledge: A Causal Comparative Study

J. Chris Haynes

J. Shane Robinson, Assistant Professor

M. Craig Edwards, Professor

James P. Key, Professor Emeritus

Oklahoma State University

Abstract

In the next 20 years, a deficit of workers will exist in the United States which will necessitate the need for an additional 20 million skilled laborers in the workplace. Fortunately, agricultural education exists in part, to develop competencies of students for successful employment in the agricultural industry. The purpose of this causal comparative study was to determine the effect that a science-enhanced curriculum would have on students' agricultural content knowledge. The purposeful sample population for this study consisted of students whose secondary agricultural education instructors held a science credential in Oklahoma, and were selected by Agricultural Education Division staff to use the curriculum. Additionally, 10 equally credentialed instructors forming a purposeful comparison group were selected according to specific variables (i.e., EOI scores, API scores, and SES status) for equivalency purposes. The findings of this study revealed a statistically significant difference in agricultural technical competence in animal science and horticulture as a result of the treatment. Recommendations point to the need for study replication to ensure the accuracy of the findings. Additionally, comparison of the treatment and comparison curriculums should be completed to determine where deficiencies may exist in the "traditional" curriculum.

Introduction

It has been projected that in the next 20 years a deficit of workers will exist in the United States which will require an additional 20 million skilled laborers in the workforce (Carnevale & Desrochers, 2003; Eldredge & Johnson, 2008). These additional employees will be needed to fill positions vacated by the retirement of the "baby boomer" generation. The shortage of skilled workers positioned to replace the retiring "baby boomer" generation is deficient and is considered to be an increasing dilemma in our Nation (Slusher, Robinson, & Edwards, 2010). Fortunately, one purpose of agricultural education is to develop competencies of students for successful employment in the agricultural industry (Phipps & Osborne, 1988). Therefore, career and technical instructors (e.g., agricultural educators) must continue to prepare secondary students for the workforce (Lynch, 2000).

A more technologically driven workplace has necessitated the need for a trained workforce acclimatized to the needs of a global society and an economy positioned for transitional change (Friedman, 2005). The Smith-Hughes Act, along with multiple reauthorizations of the Carl D. Perkins Vocational and Technical Education Act, has been responsible for educational reform over the years and has amplified the call for increased rigor and career opportunities in career and technical education (CTE) to meet industry needs (Ruffing, 2006) and academic expectations.

As a response to this call and a way to become more career-focused, career clusters were instituted in agriculture curriculums (Ruffing, 2006) in which development of academic skills

and industry needs became the focus (2006). In Oklahoma, the Agriculture, Food, and Natural Resources career cluster is divided into seven pathways, two of which include animal science and plant and soil science (i.e., horticulture) courses (ODCTE, 2010). These pathways aid in the teaching of curriculum aimed at increasing competencies necessary for post secondary employment and higher education (Slusher et al., 2010).

Wilmer (2008) stated that the majority of America's high school students are not prepared adequately for the workforce or post-secondary education. Research suggests that expectations of higher education and preparation of secondary students are not aligned and is thus creating a potential block toward student success in post-secondary education (Breneman, Ewell, McCluskey, Reindl, & Volkwein, 2004). This hindrance to post-secondary educational access is evident where enrollment in developmental coursework (i.e., remediation) exceeds 40% for freshman students enrolled in two-year colleges and encompasses almost one fourth of all freshman enrolled in four-year institutions (Stephens, 2001). Wilmer (2008) opined that, "... when students need developmental coursework in reading, basic arithmetic or a combination of subjects, their risk factor of not achieving their academic goals significantly increases" (p. 6). Cavanagh (2004) opined that perhaps the reason students' academic skills are diminishing is because of the overemphasis on stringent testing requirements. Provasnik, Gonzales, and Miller (2009) compared the average science scale scores of students in the United States to international students and found that Oklahoma ranked 28th in the nation out of the 45 states who reported science achievement scores. These figures are discouraging and serve as an indicator of the lack of preparedness of students for higher education and the real world. Cavanagh (2004) stated that, according to American College Testing Program (ACT), 78% of students who took a college entrance examination were deficient in the areas of mathematics, science, and English. Thus, it was determined that these students were ill-prepared for college-level coursework, justifying further the need for improvements at the secondary level. Additionally, it was noted in the latest Program for International Student Assessment (PISA) report that, "U.S. 15-year-olds are not able to apply scientific knowledge and skills to real world tasks as well as their peers . . ." (Provasnik et al., 2009, p. 45).

Because it has long been lauded as the world's oldest science (Ricketts, Duncan, & Peake, 2006), agricultural education strives to help students understand scientific principles and concepts better in the context of agriculture (Thompson & Balschweid, 2000) and exists, in part, to prepare people for college and careers (Roberts & Ball, 2009). As such, agricultural education serves as the ideal medium to convey scientific principles, which should be viewed positively, especially in a time when increased graduation requirements and other constraints mandated by No Child Left Behind (NCLB) eliminates many options for students considering elective coursework during their high school experience (Luft, 2004).

To help convey scientific principles in the context of agriculture, the Center for Agricultural and Environmental Research and Training (CAERT) curriculum was developed. CAERT provides agriculturally based, science-enhanced materials for use in agricultural and environmental instruction at the secondary level. Specializing in activities that are collaborative, students of agricultural education are provided with a technologically-enhanced curriculum where they are actively involved and engaged in the learning process (CAERT, 2010).

Prensky (2001a) stated that, "Today's students are no longer the people our educational system was designed to teach" (p. 1). Rather they are more adept at using cellular phones, compact disc players, computers, and video games because they have spent the majority of their lives exposed to these forms of technology (McAlister, 2009; Prensky, 2001a). Prensky estimated that today's

college graduate has spent in excess of 30,000 hours immersed in playing video games and watching television, compared to 5,000 hours of their lives engaged in reading. Therefore, Prensky (2001b) opined that the millennial's brain is in fact "hardwired" differently than those of the "baby boomer" generation. Previous research has identified that the brain is organized according to the sensory inputs and the way it makes meaning of its surroundings (Caine & Caine, 1989; Caine & Caine, 1990). As such, these "digital natives" have lost touch with traditional pedagogical methods of instruction (i.e., lecture, reading passages, and paper and pencil tasks) (Prensky, 2001a).

Similar to previous generations, digital natives must also be literate in agriculture because understanding agriculture is imperative for the survival of humankind. The National Research Council (1988) identified the need for agricultural literacy instruction for all students from kindergarten to graduation. Knobloch and Martin (2002) emphasized the need for agricultural awareness in the classroom by exploring teacher characteristics toward implementing and integrating agriculture into their curriculum. They found that teachers had positive perceptions about incorporating agricultural content in their curriculum. Moreover, Bottoms (1998) posited that higher learning and greater achievement can be realized through an integrated curriculum. This was supported by Bottoms and Sharp (1996) who stated that academic and vocational integration of "real world" concepts holds the key to enhancing student learning. Too often, concepts, ideas, and other scenarios with no connection to the "real world" prohibit true transfer of learning to occur.

A study by Parr, Edwards, and Leising (2009) identified the effects of a curricular integration on mathematics performance. When evaluated according to secondary students in an agricultural power and technology course (APT), it was determined there was not a reduction in students' mathematical knowledge as a result of the integration. A similar study was conducted by Young, Edwards, and Leising (2009) on students' technical competence in agriculture, after a mathematical curricular integration in an APT course. The researchers found that an "aligned instructional approach could be a practical method of increasing students' academic skills in mathematics without diminishing their acquisition of technical skills (p. 123)."

Because agriculture is the largest employer in the United States (National FFA Organization, 2010), an emphasis on agricultural literacy provides an essential contextual learning opportunity in today's classrooms (Knobloch & Martin, 2002). According to Balschweid, Thompson, and Cole (2000), "the integration of science into the agriculture curricula is a more effective way to teach science" (p. 37). But, what effect, if any, does a science-enhanced curriculum have on the students' ability to learn the agriculture content?

Theoretical Framework

This study was undergirded by the constructivism and brain-based learning (BBL) theories whereby people learn in authentic environments by connecting their learning to prior knowledge (Doolittle & Camp, 1999). The constructivist theory, according to Brown (1998) as cited in Parr et al. (2009), relies on strategies of implementation such as, "student-centered teaching, project-oriented instruction, problem-based learning, and contextual teaching and learning (p. 59)."

Specifically, Caine and Caine (1995) stated that the brain is a parallel processor, capable of performing functions and activities simultaneously making the most of learning. The brain factors "thoughts, emotions, imagination, and predispositions" (Caine & Caine, 1990, p. 66) in a seamless fashion; therefore, the concept of contextual teaching and learning is promising (Parr et al., 2006). Connections must be made in education between the acquisition of knowledge and its practical application in the "real world" (Parr et al., 2009). Regardless, for effective construction

to occur, learning must be meaningful and relevant to students (Caine & Caine, 1989). As a result, educators should take advantage of the academic possibilities of brain-based learning and develop lessons and curriculum suitable for this modality of learning (Caine & Caine, 1995). These contextual experiences are unique, but contain relevant points of continuity that transfer from each distinctive learning experience (Caine & Caine, 1994). Specifically, it is evident that the primary goal should be for educators, as well as learners is to move away from the concept of memorization and toward the embrace of meaningful learning (Bellah et al., 2007). For this to occur, the brain must be relaxed, immersed, and active (Caine & Caine, 1989).

Statement of the Problem

The demand for workers who are agriculturally literate and capable of applying their understanding of agriculture in the workplace is imperative. Agricultural education, at the secondary level, including animal science and horticulture curricula's, is inherently based on fundamental science principles and concepts. But, how would teaching a science-enhanced curriculum in the context of animal science or horticulture courses affect students' agricultural content knowledge, generally? Does a science-enhanced curriculum diminish or enhance students' abilities to learn agriculture?

Purpose and Objectives

The purpose of this causal comparative study was to determine the effect that a science-enhanced CAERT curriculum would have on students' agricultural knowledge when compared to students who were instructed using a traditional curriculum. The following research questions guided the study.

1. What were the personal characteristics (i.e., gender, age, grade classification, and race/ethnicity) of students enrolled in selected animal science or horticulture courses in Oklahoma during spring semester 2010?
2. What effect did the science-enhanced CAERT curriculum, designed for animal science or horticulture courses, have on students' agricultural technical skill competence, as determined by state competency examinations for animal science and horticulture?

Null Hypothesis

H₀1: The agricultural technical competence of students who received the science-enhanced CAERT animal science or horticulture curriculum will not differ significantly (i.e., $p < .05$) from those students who received a traditional animal science or horticulture curriculum, as measured by a technical competency test in animal science or horticulture ($H_0: \mu_1 \text{ treatment group} = \mu_2 \text{ comparison group}$).

Methods

The population for this study consisted of students whose secondary agricultural education instructors held a science credential in Oklahoma during the 2008-2009 school year. The purposeful sample consisted of 10 treatment group teachers who were selected by Agricultural Education Division staff of the Oklahoma Department of Career and Technology Education to use the science-enhanced CAERT curriculum developed for the instruction of animal science and horticulture courses during the 2009-2010 school year. In addition, 10 different instructors formed a purposeful comparison group. These teachers also held a science credential and were selected according to specific demographic data obtained from the 2008-2009 Computerized Enrollment System for Instructors (CESI) report. The CESI report is used by the ODCTE, Information Management Division to collect student demographic information of Oklahoma

secondary agricultural education programs and their students. Therefore, schools that “matched” the treatment group based on review of established criteria were selected to provide an appropriate counterfactual group for the comparison of results. The criteria were established by the National Research Center for Career and Technical Education (NRCCTE), who also provided partial funding for the study. As such, all students ($N = 179$), whose teachers were selected to participate in the study, were administered competency examinations. The instructors’ classrooms served as the study’s “units of analysis” for purposes of comparisons. The design of the study was *ex post facto*, causal comparative because no random assignment of the treatment group occurred. The treatment group was “pre-determined” through selection of instructors by ODCTE staff, i.e., agricultural education teachers who received access to the CAERT curriculum. The curriculum was designed to explicate and reinforce scientific principles through the instruction of select agricultural education courses, including modules supported by downloadable lesson plans, aligned learning standards, summary reports, PowerPoint® files, and E-Units (K. Murray, personal communication, October 1, 2009). The CAERT curriculum was selected for use because it was developed according to standards in agricultural education for Oklahoma, acceptable for science credit for college entrance purposes, and consisted of an online delivery method. As a result of the state alignment, the animal science curriculum included 28 units with 160 instructional lessons, and the horticulture curriculum included 29 units with 148 lessons (CAERT, 2010). The unique purpose of CAERT is that it is a science-enhanced curriculum not otherwise offered by curriculum providers currently in use in Oklahoma. (K. Murry, personal communication, October 1, 2009)

The treatment group teachers were provided access to the CAERT curriculum via passwords and user names in summer 2009. These teachers were instructed to become familiar with the modules pertaining to animal science and horticulture prior to the beginning of the fall semester.

Additionally, this group of teachers was brought onto the ODCTE campus for a one-half day training seminar during September 2009 for an overview of the curriculum (i.e., the functions of the curriculum and how to use its teaching resources).

For the purpose of testing this study’s intervention (i.e., CAERT curriculum), a purposeful comparison group was selected from the same list of agricultural education teachers who had achieved science certification in Oklahoma ($N = \sim 40$). This group was instructed to teach their courses (i.e., animal science or horticulture) as they had in the past.

Measures were instituted to ensure a reliable assessment of fidelity for the study. During the research period, both treatment and control group instructors were requested to complete a weekly measure of fidelity through an online weekly report protocol. Specifically, teachers were asked to identify the courses, units of instruction, instructional topics, types of curriculum sources, and types of instructional techniques used to teach the curriculum.

The assumption was made that students’ agricultural technical competency in animal science or horticulture would remain at the same level in both the treatment and comparison groups after the treatment was administered. Further, it was assumed that both of these groups (treatment and comparison) were equivalent. To determine equivalency of the treatment and comparison groups, students were compared on their performance of the Oklahoma Department of Education’s End of Instruction (EOI) examination in science, as well as district academic performance index and accountability data (API), and the schools percentage of low income clientele served by the free and reduced lunch program.

The Oklahoma Department of Education’s EOI examination in science is a part of a larger statewide testing program known as the Oklahoma School Testing Program (OSTP) (Oklahoma

State Department of Education, 2010a). Students completing an area of instruction are expected to pass the corresponding standardized assessment. EOI examinations are designed to assess a students' level of competency relative to the Priority Academic Student Skills (PASS), which are Oklahoma content standards (Oklahoma State Department of Education, 2010b).

The Academic Performance Index for Oklahoma was developed based on the need to compare school performance to meet requirements established by Oklahoma law, as well as legislation pursuant to Public Law 107-110, commonly referred to as No Child Left Behind (Oklahoma State Department of Education, 2010c). API scores range from 0 to 1500, with the most recent reported state average being 1279 (2010c). Components of a schools' API include EOI scores, Academic Excellence as measured by students' participation on the ACT college entrance examination, remediation rates for college students in reading and mathematics, and school completion as determined by student attendance coupled with graduation and dropout rates (2010c). To ensure equivalency of the treatment and comparison groups, schools were compared on the basis of EOI scores, API, as well as socio economic status (SES).

When comparing these variables for equivalency, the treatment group had an EOI group mean score of 2.67 ($SD = 1.12$). The mean score for the comparison group was 2.88 ($SD = .93$). The treatment group had an API group mean score of 1387.00 ($SD = 57.42$); the mean score for the comparison group was 1295.86 ($SD = 74.40$). The treatment group had an SES group mean score of 44.85 ($SD = 13.94$); mean score for the comparison group was 43.53 ($SD = 9.40$) (Table 1). An independent samples *t*-test was used to compare the treatment and comparison group participants on the EOI, API, and SES factors. It was revealed that a statistically significant difference in API scores existed between the two groups ($p = .045$) at an *a priori* alpha level of .05. Therefore, the reader is cautioned on making generalizations beyond this sample.

Table 1

Treatment and Comparison Group Equivalency According to EOI, API, and Socio-Economic Status

Groups	Min. & Max.	<i>M</i>	<i>SD</i>	<i>t</i> -value	<i>p</i> -value
EOI ^a	1 - 4	2.67	1.12	-.561	.579
EOI ^b		2.88	.93		
API ^a	0 - 1500	1387.00	57.42	2.290	.045*
API ^b		1295.86	74.40		
SES ^a	0 - 100%	44.85	13.94	.197	.848
SES ^b		43.53	9.40		

* $p < .05$

^a = Treatment

^b = Comparison

To measure the effect of a science-enhanced CAERT curriculum on students' agricultural knowledge, the ODCTE's online agricultural education competency-testing program was used. Students in Oklahoma have the opportunity to complete a competency examination in their

particular curriculum area (ODCTE, 2010d). Students who complete the examination successfully with a score of 70% or better receive a competency certificate and are recognized at the Oklahoma FFA Convention. The agricultural competency examination is designed to serve as a guide for instruction of the curriculum by the instructor, and to identify student mastery of competencies and skill objectives needed for employment in industry. As such, this examination could serve as a potential form of accountability for course credit (2010d). To achieve this study's purpose, competency examinations in the areas of animal science and horticulture were used.

School district testing liaisons arranged for and proctored the examinations. The examination is aligned with Oklahoma skill standards that address a wide range of precise areas specific to curriculum in agricultural education. Business and industry representatives in Oklahoma coupled with agricultural educators evaluate the skills, knowledge, and competencies needed for successful completion of the subject matter and develop questions accordingly. These competency examinations were conducted at the end of the 2010 spring semester (~ late April). The examination scores needed to determine the level of students' agricultural technical competency were obtained through the ODCTE's assessment specialist who facilitates the examination procedure.

Data Analysis

Statistical analysis for the study was completed with the *Predictive Analytics Software (PASW) 18.0* and *Microsoft Excel 2007*. To assess research question one, students selected for the study were asked to identify characteristics pertaining to their gender, age, grade classification, and race/ethnicity. To summarize trends and tendencies relating to the personal characteristics data, descriptive statistics (i.e., mean, median, mode, frequency, and percentages) were computed. To assess research question two, an independent *t*-test was used. Ary, Jacobs, and Razavieh (2002) identified that a *t*-test for independent samples serves as an ideal statistical procedure for determining statistically significant differences between groups.

Effect sizes were also calculated to determine what practical effect the treatment had on the post-treatment measures of the study (i.e., animal science and horticulture agricultural competency examinations). The effect size was calculated according to Cohen (1988). According to Cohen, effect size is calculated and compared to three benchmark standards: "small" effect size ($d = .20$), "medium" effect size ($d = .50$), and "large" effect size ($d = .80$). Research by Thompson (2002) indicated that adherence to this standard may be too stringent for Cohen and that the effect itself has to do with what has been studied. Therefore, "large" effect sizes can be considered trivial when applied to outcomes that are in fact trivial (Trusty, Thompson, & Petrocelli, 2004). As such, the distribution of Cohen's *d* effect sizes for this study were compared to standards developed by Thalheimer and Cook (2002) (Table 2).

Table 2

Relative Size of Cohen's d According to Thalheimer and Cook (2002)

Effect Size Classification	Relative Size
Negligible Effect	$> = - 0.15$ and $< .15$
Small Effect	$> = .15$ and $< .40$
Medium Effect	$> = .40$ and $< .75$

Large Effect
 Very Large Effect
 Huge Effect

$\geq .75$ and < 1.10
 ≥ 1.10 and < 1.45
 > 1.45

Results/Findings

Research question one sought to determine the personal characteristics (i.e., gender, age, grade classification, and race/ethnicity) of students enrolled in animal science or horticulture courses in Oklahoma during the study ($N = 80$). The students who were involved in the study were asked for their personal characteristics information in conjunction with their post-test administration. A total of 69 students completed the questionnaire (treatment $n = 29$; comparison $n = 40$). These data were analyzed using frequencies and percentages.

The treatment group respondents consisted of 16 females (55%) and 13 males (45%) (Table 3). Of those students none were 14 years of age, one was 15 (3%), nine were 16 (31%), six (21%) were 17, and 13 respondents (45%) were 18 years of age or older (Table 3).

Twenty-four respondents (83%) self-selected their race/ethnicity as "White/Caucasian." Four respondents (14%) self-selected their race/ethnicity as "American Indian/Alaskan Native/Pacific Islander," and one respondent (3%) identified his/her race/ethnicity as "other."

Eleven (38%) were in the tenth grade, four of the respondents (14%) were in the eleventh grade, and 14 (48 %) were in the twelfth grade.

Table 3

Selected Personal Characteristics of Treatment ($N= 29$) and Comparison ($N= 40$) Group Secondary Agricultural Education Students

Variable	Treatment		Comparison	
	<i>f</i>	%	<i>f</i>	%
Gender				
Male	13	44.8	18	45.0
Female	16	55.2	22	55.0
Age				
14	0	0.0	1	2.5
15	1	3.4	5	12.5
16	9	31.0	15	37.5
17	6	20.7	11	27.5
18+	13	44.8	8	20.0
Race/Ethnicity				
White/Caucasian	24	82.8	34	85.0
American Indian/Alaskan Native/Pacific Islander	4	13.8	5	12.5
Other	1	3.4	1	2.5
Grade Classification				

9 th	0	0.0	6	15.0
10 th	11	37.9	17	42.5
11 th	4	13.8	7	17.5
12 th	14	48.2	10	25.0

The comparison group consisted of 22 (55%) females and 18 (45%) males. One student (3%) was 14 years old and five (13%) were 15. Fifteen students (38%) were 16 years of age, eleven (28%) were 17, and eight (20%) were 18 years of age or older.

Thirty-four respondents (85%) self-selected their race/ethnicity as “White/Caucasian.” Five (13%) were “American Indian/Alaskan Native/Pacific Islander.” One student (3%) identified the “other” classification.

Regarding grade classification of the comparison group, the bulk of the sample was evenly distributed across four grade classification levels: Six respondents (15%) were ninth graders, 17 (43%) were tenth graders, seven (18%) were in the eleventh grade, and 10 (25%) were in the twelfth grade.

Research question two sought to determine what effect the science-enhanced CAERT curriculum, designed for animal science or horticulture courses, had on students’ agricultural technical skill competence, as determined by state competency examinations for animal science and horticulture. Students’ technical competence was evaluated through the ODCTEs agricultural competency examinations in animal science and horticulture.

The treatment group ($N = 47$) that participated in the horticulture competency examination had a group mean score of 37.47 ($SD = 6.62$) (Table 4). The mean score for the comparison group ($N = 75$) was 31.48 ($SD = 6.55$). The treatment group ($N = 13$) that participated in the animal science competency examination had a group mean score of 40.85 ($SD = 7.05$). The mean score for the comparison group students ($N = 44$) was 32.05 ($SD = 7.70$).

Table 4

Agricultural Competency Examination Scores of Horticulture and Animal Science Treatment and Comparison Groups

Competency Examination	<i>f</i>	Min. & Max.	<i>M</i>	<i>SD</i>	<i>t</i> -value	<i>p</i> -value*
Horticulture	Treatment	0-55	37.47	6.62	4.89	.000 ^a
	Comparison		31.48	6.55		
ANSI	Treatment	0-55	40.85	7.05	3.69	.001 ^b
	Comparison		32.05	7.70		

* $p < .05$

^aEffect size = “Large” (.92 per Cohen’s *d*)

^bEffect size = “Very Large” (1.18 per Cohen’s *d*) (Thalheimer & Cook, 2002)

An independent samples *t*-test comparison of the treatment and counterfactual groups for horticulture revealed a statistically significant difference in technical competence as a result of the treatment ($p = .000$) at an *a priori* alpha level of .05 (Table 4). In order to ensure the equality of variances, Levene's test for equality of variances was conducted ($\alpha = .764$). Further, the effect size, calculated according to Thalheimer and Cook (2002), resulted in a "large" effect ($d = .92$). Additionally, it was revealed that a statistically significant difference in technical competence among the two groups regarding the competency examination in animal science ($p = .001$) existed. In order to ensure the equality of variances, Levene's test for equality of variances was conducted ($\alpha = .506$). Effect size for the animal science competency examination was calculated, which resulted in a "very large" effect ($d = 1.18$). As a result of the *t*-test comparisons for both the horticulture and animal science courses, it was determined that a positive effect, statistically and practically, existed regarding the agricultural competency (i.e., animal science and horticulture) of those students who received the treatment. As such, the null hypothesis (H_0) was rejected, indicating that the science-enhanced CAERT curriculum had a positive and statistically significant effect on students' technical competency.

Conclusions

The purpose of this study was to determine the effect of a science-enhanced curriculum on students' technical competence when compared to students who were instructed using a traditional curriculum in animal science or horticulture. It was concluded that the science-enhanced CAERT curriculum had a positive and statistically significant effect on students' ability to learn agriculture. This finding is consistent with research by Parr et al. (2006) and Young et al. (2009) who found that agricultural content knowledge did not diminish when the integration of mathematics occurred.

Specifically, students in the treatment group scored nearly six points higher on the horticulture competency examination than did students in the comparison group. Likewise, students in the treatment group scored nearly nine points higher on the animal science competency examination than did the students in the comparison group. This finding is especially intriguing because the comparison group students had higher EOI scores (pre-test) as compared to the treatment group students. The effect sizes for the animal science and horticulture curricula were "large" and "very large," respectively, supporting research by Bottoms (1998) who concluded that greater achievement can be realized through an integrated curriculum.

Limitations

As a result of variables outside of the control of the researcher, certain limitations existed. For example, treatment teachers were selected purposefully by ODCTE state staff. Because randomization did not occur with teacher selection, the generalizability of the study suffered. Additionally, EOI data were not accessible on each student who participated in the study. The researchers attempted to acquire EOI scores on multiple occasions. However, in Oklahoma, each school district "houses" its own student database (i.e., EOI results). As such, some schools were reluctant to release those data for the purpose of the study. Moreover, API scores used for school comparison were found to be statistically significant indicating a higher degree of aptitude in the treatment group schools overall. Further, no incentives were provided for the teachers. As such, some teachers chose not to provide fidelity reports, use the curriculum in its entirety, or test their students accordingly.

Implications

Implications exist per curriculum enhancement. Why did the CAERT curriculum have a positive effect on students? Is the “traditional” curriculum outdated and in need of revision? Because the teachers in the treatment group knew they had been selected by state staff (ODCTE) to receive special treatment per acceptance of the CAERT curriculum, did they teach with more focus or intent? Or, maybe because of its digital mode of delivery, the intervention (i.e., CAERT curriculum) was more meaningful and relevant to these digital native students because it was technologically-based (Prensky, 2001a). Prensky noted that today’s students have changed drastically and are not “in tune” with traditional pedagogical methods of instruction. Maybe those teachers comprising the comparative group were more “traditional” in their mode of delivering content. If so, this would support Brazen and Clark (2005) assertion that teachers who continue to solely rely on the lecture format of instruction are deemed to be less effective in the classroom.

Recommendations for Research

Future research should be conducted to determine which mode of delivery students like best. From a pedagogical perspective (Brazen & Clark, 2005), it is important to determine which teaching methods have the most impact on student learning. This study should be replicated with additional teachers and students to confirm or refute the findings of the present study to ensure the accuracy that this science-enhanced CAERT curriculum treatment is capable of significantly affecting students’ ability to learn agriculture. In future studies, randomization should occur with teachers in an effort to generalize the findings more widely. Finally, it would be important to re-test these same students on their agricultural competencies again to determine how much learning was retained. In other words, does the treatment group retain knowledge related to agricultural technical competencies longer than the comparison group? Future research should examine this phenomenon.

Recommendations for Practice

The science-enhanced CAERT curriculum should be compared to the “traditional” curriculum used currently in Oklahoma to determine where differences or deficiencies exist. Once identified, the “traditional” curriculum could be revised and enriched. Further, the agricultural technical competency examination should be crosswalked with both curriculums (i.e., CAERT and “traditional”) to determine how many of the test items are represented in the curriculums. It could be that the CAERT curriculum is more aligned “naturally” to the agricultural technical competency examination than is the “traditional” curriculum.

References

- Apple, M. W. (2006). What can we learn from Texas about no child left behind? *Educational Policy*, 20(3), 551–560. doi: 10.1177/0895904805284113
- Ary, D., Jacobs, L. C., & Razavieh, A. (2002). *Introduction to research in education*. Belmont, CA: Wadsworth/Thomson Learning.
- Balschweid, M. A., Thompson, G. W., & Cole, R. L. (2000). Agriculture and science integration: A pre-service prescription for contextual learning. *Journal of Agricultural Education*, 41(2), 36–45. Retrieved from <http://www.jae-online.org/> doi: 10.5032/jae.2000.02036

- Bellah, K. A., Robinson, J. S., Kaufman, E. K., Akers, C., Hasse-Wittler, P., & Martindale, L. (2008). Brain-based learning: A synthesis of research. *NACTA Journal*, 52(2), 15–22.
- Bottoms, G. (1998). *Things that matter most in improving student learning*. Atlanta, GA: Southern Regional Education Board.
- Bottoms, G. & Sharp, D. (1996). *Teaching for understanding through integration of academic and technical education*. Atlanta, GA: Southern Regional Education Board.
- Brazen, E. F., & Clark, C. D. (2005). Promoting interactive learning with an electronic student response system. *NACTA Journal*, 49(3), 11–16.
- Breneman, D. W., Ewell, P. T., McCluskey, N. P., Reindl, T., & Volkwein, F. (2004). Grading the higher-education report card. [Article]. *Chronicle of Higher Education*, 51(8), B9–B11.
- Brown, B. A. (1998). *Integration of academic and vocational education myths and realities*. Retrieved from http://eric.ed.gov/ERICDocs/data/ericdocs2sql/content_storage_01/0000019b/80/15/32/71.pdf
- Center for Agricultural and Environmental Research and Training (2010). Facts and mission. Retrieved from <http://www.caert.net/mission.asp>
- Caine, G., & Caine, R. N. (1989). Learning about accelerated learning. *Training & Development Journal*, 43(5), 64–73.
- Caine, R., & Caine, G. (1994). *Making connections: Teaching and the human brain*. Menlo Park, CA: Addison-Wesley Pub. Co.
- Caine, R. N., & Caine, G. (1990). Understanding a brain-based approach to learning and teaching. *Educational Leadership*, 48(2), 66–70. Retrieved from <http://www.coe.iup.edu/grbieger/classes/curr910/readings/brainbasedlearning.pdf>
- Caine, R. N., & Caine, G. (1995). Reinventing schools through brain-based learning. *Educational Leadership*, 52(7), 43–47.
- Carnevale, A. P., & Desrochers, D. M. (2003). Preparing students for the knowledge economy: What school counselors need to know. *Professional School Counseling*, 6(4), 228–237.
- Cavanagh, S. (2004). Students ill-prepared for college, ACT Warns. *Education Week*, 24(8), 5–5.
- Chipongian, L. (2007). *What is “brain-based learning”?* Oakland, CA: Scientific Learning Corporation. Retrieved from <http://stemrc.aihec.org/computers/BPC2/Shared%20Documents/brainbasedlearning.pdf>

- Cohen, J. (1988). *Statistical power analysis for the behavioral sciences* (2nd ed.). Hillsdale, NJ: Lawrence Erlbaum Associates.
- Creswell, J. W. (2008). *Educational research : Planning, conducting, and evaluating quantitative and qualitative research* (3rd ed.). Upper Saddle River, NJ: Pearson/Merrill Prentice Hall.
- Doolittle, P.E., & Camp, W.G. (1999). Constructivism: The career and technical education perspective. *Journal of Vocational and Technical Education*, 16(1), 23-46. Retrieved from <http://scholar.lib.vt.edu/ejournals/jvte/v16n1/doolittle.html>
- Eldredge, B., & Johnson, P. R. (2008). *Cycling boomers a new retirement ideal*. Paper presented at the Academy of Organizational Culture, Tunica.
- Friedman, T. L. (2005). *The world is flat: A brief history of the twenty-first century*. New York, NY: Farrar, Straus and Giroux.
- Knobloch, N. A., & Martin, R. A. (2002). Teacher characteristics explaining the extent of agricultural awareness activities integrated into the elementary curriculum. *Journal of Agricultural Education*, 43(4), 12–23. Retrieved from <http://www.jae-online.org/> doi: 10.5032/jae.2002.04012
- Luft, V. D. (2004). Accountability: Not a destination, but a never ending journey. *Journal of Agricultural Education*, 45(1), 1–9. doi: 10.5032/jae.2004.01001
- Lynch, R. L. (2000). High school career and technical education for the first decade of the 21st century. *Journal of Vocational Education Research*, 25(2), 155–198. Retrieved from <http://search.ebscohost.com/login.aspx?direct=true&db=eric&AN=EJ625954&site=ehost-live>
- Martin, M. J., Fritzsche, J. A., & Ball, A. L. (2006). A Delphi study of teachers' and professionals' perceptions regarding the impact of the No Child Left Behind legislation on secondary agricultural education programs. *Journal of Agricultural Education*, 47(1), 100–109. doi: 10.5032/jae.2006.01101
- McAlister, A. (2009). Teaching the millennial generation. *American Music Teacher*, 59(1), 13–15. Retrieved from <http://search.ebscohost.com.ezproxy.osu-tulsa.okstate.edu/login.aspx?direct=true&db=aph&AN=43802552&site=ehost-live>
- National Commission on Excellence in Education. (1983). A nation at risk: The imperative for educational reform. *The Elementary School Journal*, 84(2), 113–130.
- National FFA Organization (2010). *FFA & agriculture statistics*. Retrieved from http://www.ffa.org/index.cfm?method=c_about.stats

- National Research Council. (1988). *Understanding agriculture: New directions for education*. Danville, IL: The Interstate Printers and Publishers.
- Newcomb, L. H., McCracken, J. D., Warmbrod, J. R., & Whittington, M. S. (2004). *Methods of teaching agriculture* (3rd ed.). Upper Saddle River, NJ: Pearson/Prentice Hall.
- Parr, B. A., Edwards, M. C., & Leising, J. G. (2006). Effects of a math-enhanced curriculum and instructional approach on the mathematics achievement of agricultural power and technology students: An experimental study. *Journal of Agricultural Education*, 47(3), 81–93. Retrieved from <http://www.jae-online.org/> doi: 10.5032/jae.2006.03081
- Parr, B. A., Edwards, M. C., & Leising, J. G. (2009). Selected effects of a curriculum integration intervention on the mathematics performance of secondary students enrolled in an agricultural power and technology course: An experimental study. *Journal of Agricultural Education*, 50(1), 57–69. Retrieved from <http://www.jae-online.org/> doi: 10.5032/jae.2009.01057
- Phipps, L. J., & Osborne, E. W. (1988). *Handbook on agricultural education in public schools* (5th ed.). Danville, Ill.: Interstate Printers & Publishers.
- Prensky, M. (2001a). Digital natives, digital immigrants part 1. *On the Horizon*, 9(5), 1–6. doi:10.1108/10748120110424816
- Prensky, M. (2001b). Digital natives, digital immigrants part 2: Do they really think differently? *On the Horizon*, 9(6), 1–10. doi:10.1108/10748120110424843
- Provasnik, S., Gonzales, P., & Miller, D. (2009). U.S. performance across international assessments of student achievement: Special supplement to the condition of education 2009. NCES 2009–083: National Center for Education Statistics.
- Ricketts, J. C., Duncan, D. D., & Peake, J. B. (2006). Science achievement of high school students in complete programs of agriscience education. *Journal of Agricultural Education*, 47(2), 48–55. doi: 10.5032/jae.2006.02048
- Roberts, T. G., & Ball, A. L. (2009). Secondary agricultural science as content and context for teaching. *Journal of Agricultural Education*, 50(1), 81–91. doi: 10.5032/jae.2009.01081
- Ruffing, K. (2006). The history of career clusters [Electronic version]. *Association of Career and Technical Education*. Retrieved from www.careerclusters.org/resources/publications/TheHistoryofCareerClusters2006.pdf
- Slusher, W. L., Robinson, J. S., & Edwards, M. C. (2010). *An assessment of the animal science technical skills secondary agricultural education graduates need for employment in the*

animal science industry: A Delphi study. Paper presented at the 2010 Annual Southern Region Research Conference in Agricultural Education, Orlando, FL.

Oklahoma Department of Career and Technology Education. (2010a). *Divisions*. Retrieved from <http://www.okcareertech.org/main/division.htm>

Oklahoma Department of Career and Technology Education. (2010b). *Ag standards*. Retrieved from <http://www.okcareertech.org/aged/ag%20standards1.htm>

Oklahoma Department of Career and Technology Education. (2010c). *CareerTech Glossary*. Retrieved from <http://cms.okcareertech.org/glossary>

Oklahoma Department of Career and Technology Education. (2010d). *Agricultural education competency testing*. Retrieved from http://www.okcareertech.org/aged/ag_education_competency_testing.htm

Oklahoma State Department of Education. (2010a). *Accountability and Assessment*. Retrieved from <http://sde.state.ok.us/acctassess/core.html>

Oklahoma State Department of Education. (2010b). *Priority academic student skills (PASS)*. Retrieved from <http://sde.state.ok.us/Curriculum/PASS/default.html>

Oklahoma State Department of Education. (2010c). *Measuring success in Oklahoma schools*. Retrieved from <http://sde.state.ok.us/AcctAssess/pdf/API/Brochure.pdf>

Stephens, D. (2001). Increasing access: Educating underprepared students in U.S. colleges and universities past, present, and future. Retrieved from <http://faculty.etsu.edu/Stephen/increasingaccess.htm>

Thalheimer, W., & Cook, S. (2002, August). *How to calculate effect sizes from published research articles: A simplified methodology*. Retrieved from http://work-learning.com/effect_sizes.htm

Thompson, B. (2002). What future quantitative social science research could look like: Confidence intervals for effect sizes. *Educational Researcher*, 31(3), 25–32.

Thompson, G. W., & Balschweid, M. M. (2000). Integrating science into agriculture programs: Implications for addressing state standards and teacher preparation programs. *Journal of Agricultural Education*, 41(2), 73–80. Retrieved from <http://www.jae-online.org/> doi: 10.5032/jae.2000.02073

Trusty, J., Thompson, B., & Petrocelli, J. V. (2004). Practical guide for reporting effect size in quantitative research in the journal of counseling & development. *Journal of Counseling & Development*, 82(1), 107–110.

- Wilmer, E. (2008). Student support services for the underprepared student. *Inquiry*, 13(1), 5–19. Retrieved from <http://www.vccaedu.org/inquiry>
- Young, R. B., Edwards, M. C., & Leising, J. G. (2009). Does a math-enhanced curriculum and instructional approach diminish students' attainment of technical skills? A year-long experimental study in agricultural power and technology. *Journal of Agricultural Education*, 50(1), 116-126. Retrieved from <http://www.jae-online.org/> doi: 10.5032/jae.2009.01116

Practical Implications for the Experiential Learning Theory in Agricultural Education: A Conversation with Dr. David A. Kolb

*Marshall A. Baker, Graduate Assistant
J. Shane Robinson, Assistant Professor
Oklahoma State University*

Abstract

Experiential learning has been a foundational tenant of agricultural education since its inception. However, the theory of experiential education has received limited attention in the permanent agricultural education literature base. As such, this philosophical manuscript examined Kolb's experiential learning process further, and considered the implications for experiential learning theory (ELT) in secondary agricultural education through a triangulated approach. Specifically, the researchers outlined Kolb's ELT and conducted a telephone interview with Dr. David A. Kolb. Results of this study indicated that experiential learning is a critical component of a comprehensive agricultural education model (i.e., three-circle model). It was found that experiential learning builds meta-cognitive skills and can be goal-oriented and assessed. However, agricultural educators must be present and purposeful when providing experiences for students. Additionally, they must ask reflection questions (i.e., "What happened?" "Now what?" "So what?") during each phase of ELT throughout the comprehensive agricultural education model. Based on these results, an enriched model of agricultural education was proposed to include the role of experiential learning more intentionally.

Introduction

John Dewey (1938) stated, "amid all uncertainties there is one permanent frame of reference: namely, the organic connection between education and personal experience" (p. 25). Agricultural education has been experiential in nature since its inception (Cheek, Arrington, Carter, & Randell, 1994; Hughes & Barrick, 1993; Knobloch, 2003; Roberts, 2006; Stewart & Birkenholz, 1991) as made evident by supervised agricultural experience programs (SAE), field trips, student teaching experiences, problem solving methods and service based learning (Roberts, 2006). McLean and Camp (2000) examined the curricula of ten prominent agricultural teacher education programs and found that experiential education was a critical component of each program through SAE training and teacher field experiences.

Dewey (1938) explained that, "A primary responsibility of educators is that they not only be aware of the general principle of the shaping of actual experience by environing conditions, but that they also recognize in the concrete what surroundings are conducive to having experiences that lead to growth" (p. 40). However, Roberts (2006) asserted that despite the robust use of experiential learning in agricultural education, "the theory behind the practice of experiential learning has had limited attention in the permanent agricultural education literature" (p. 18). Therefore, it is vital that the agricultural education profession focus on the theory of experiential learning in order to facilitate positive growth through experiential education.

Specifically, Roberts (2006) noted that the *practice* of experiential learning has received considerable attention in the agricultural education literature, but deficiencies exist in terms of

the examination of the *theory* of experiential education. Kayes (2002) posited, “Although a number of variants of experiential learning theory have been proposed, Kolb’s experiential learning theory continues to be one of the most influential” (p. 137). Therefore, a need exists to synthesize Kolb’s Experiential Learning Theory (ELT; D. Kolb, 1984) and determine how it can be implemented in secondary agricultural education programs more purposefully. The paucity of research regarding the theory of experiential learning, in the context of agricultural education, as well as the call to add “breadth and depth” to research “priority areas” (Edgar, Briers & Rutherford, 2008), led the researchers to examine this phenomenon more closely.

Purpose and Objectives

The purpose of this philosophical study was to examine Kolb’s experiential learning process further, and consider the implications for ELT in secondary agricultural education. The objectives were to: 1) outline the theoretical tenants of Kolb’s ELT, 2) apply Kolb’s ELT in the context of agricultural education, and 3) enrich the current model of agricultural education to include the role of experiential learning more intentionally.

Methodology

Merriam (1995) asserted that triangulation, or the use of multiple methods or sources of information, confirmed emerging themes and provided confidence that the “reality” is being reported. Thus, this philosophical study employed three different methods in order to triangulate the data. Specifically, for objective one, the researchers examined publications within Kolb’s comprehensive ELT bibliography (Kolb & Kolb, 2005) in order to glean an in-depth theoretical framework of ELT that is relevant to agricultural education. Then, per objective two, researchers contacted David A. Kolb, via email, requesting a phone interview in order to clarify and expand the role ELT has in the context of agricultural education. The researchers developed an interview protocol guided by the purpose and theoretical framework for the study. Prior to the interview, David A. Kolb was provided an informational document outlining a comprehensive agricultural education model (i.e., three-circles – classroom, FFA, SAE). The interview was recorded, transcribed, and analyzed for consistent themes. Specifically, data were analyzed and coded line-by-line “to identify core consistencies and meanings” (Patton, 2002, p. 453). Similar words, sentences, phrases and paragraphs were grouped into categories, known as themes (Dooley, 2007). The data were collected from only one participant, David A. Kolb. However, Merriam (1995) stated that, “quite a bit can be learned from an N of 1” (p. 59).

To provide an audit trail through rich, thick descriptions, the researchers used direct quotes from the interviews including the corresponding line numbers from the transcription. Finally, per objective three, researchers sought to synthesize the results from the previous two objectives by visually integrating ELT into the existing comprehensive agricultural education model (i.e., three-circle model).

Results/Findings

Objective 1: Outline the theoretical framework of Kolb’s ELT.

Kolb’s experiential learning theory (ELT; Kolb, 1984) asserted that, “Learning is the process whereby knowledge is created through the transformation of experience.” (p. 38). This perspective of the learning process originated through the work of foundational theorists of

experiential learning—William James, John Dewey, Kurt Lewin, Carl Rogers, and Paulo Freire—who placed intentional action based on subjective experience at the center of learning (Kolb & Kolb, 2008).

Kolb and Kolb, (2005b) noted six propositions shared by the above-mentioned scholars that served as the foundation for ELT. First, learning is conceived best as a process instead of a product. To improve learning, the focus must be primarily on engaging students in a process that facilitates learning best. This includes feedback on the effectiveness of students’ learning efforts. As Dewey (1897) noted, “education must be conceived as a continuing reconstruction of experience” (p. 79). Next, all learning is relearning. So, a student’s beliefs and ideas on a topic must be considered so they can be drawn out, tested, examined, and integrated into the new concepts. Third, learning requires the resolution of conflicts between dialectically opposed modes of adaption to the world. Conflict, dissonance, and disagreement drive learning. In the process of learning, an individual is called to maneuver back and forth between opposing modes of reflection and action. Fourth, learning is a holistic process of adaptation to the world. It is more than simple cognition – it involves the person as a whole and includes thinking, feeling, perceiving, and behaving. Fifth, learning results from synergetic transactions between the learner and experiences. Using Piaget’s language, learning occurs through equilibration of the dialectic processes of assimilating new experiences into existing concepts and accommodating existing concepts into new experiences. Finally, learning is the process of creating knowledge. ELT follows constructivist views of learning in that it is the process of connecting new experiences and knowledge to the learner’s pre-existing personal knowledge. This idea contrasts the majority of educational practices today, which involves the transmission of previously fixed ideas.

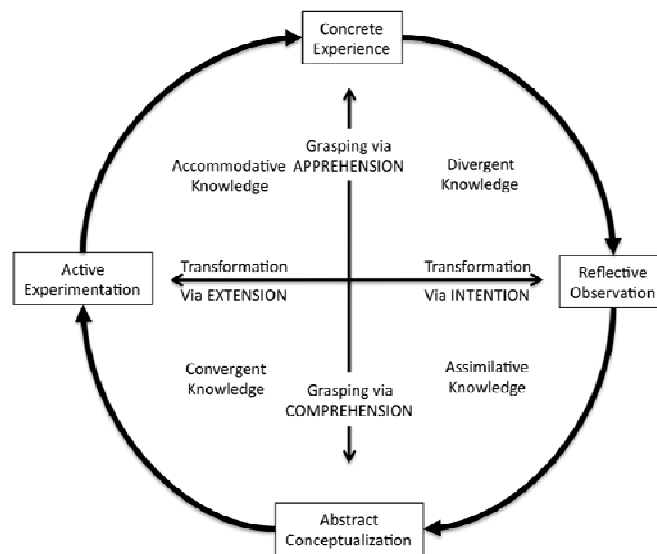

Figure 1. Model of Experiential Learning Process. Reprinted from *Experiential Learning: Experience as the Source of Learning and Development* (p. 42), by David A. Kolb, 1984, Englewood Cliffs, NJ: Prentice-Hall, Inc. Copyright 1984 by Prentice-Hall, Inc. Reprinted with permission.

These six principles provide the foundation of Kolb’s (1984) ELT Model (Figure 1). ELT explains that knowledge results from experiences that have been grasped and transformed (Kolb,

1984). The ELT puts forth two dialectically related modes of grasping experience—Concrete Experience (CE) and Abstract Conceptualization (AC)—as well as two dialectically related modes of transforming experience—Reflective Observation (RO) and Active Experimentation (AE) (Kolb & Kolb, 2008). The result of these two dimensions of learning, prehension and transformation, is four different elementary forms of knowledge—divergent knowledge, assimilative knowledge, convergent knowledge, and convergent knowledge (Kolb, 1984).

Kolb (1984) explained that an experience grasped through apprehension and then transformed through intention results in divergent knowledge. An experience grasped through apprehension and transformed through extension is accommodative knowledge. An experience grasped through comprehension and transformed through intention yields assimilative knowledge. Finally, an experience grasped through comprehension and transformed through extension leads to convergent knowledge. In order to facilitate learning, not only must the experience be grasped, but it must also be meaningful and relevant (Knapp & Benton, 2006; Ramsden, 1997), because students remember knowledge longer when they have experienced it actively (Knapp & Benton).

Experiential learning occurs through a creative tension between the four learning modes—CE, RO, AC, and AE—that is responsive to certain contexts. Thus, this process is portrayed as a learning cycle where the learner assumes each of the four domains—experiencing, reflecting, thinking, and acting (Kolb & Kolb, 2005b). This recursive process is responsive to each learner, learning experience, and content learned. Immediate or concrete experiences are the impetus for observations and reflection. Reflections are then assimilated and deduced into abstract concepts from which new implications for action are drawn. These new implications are then used through active experimentation leading to new concrete experiences (Kolb & Kolb, 2005b).

Kolb (1984) suggested that, “the learning process is not identical for all human beings. Rather, the physiological structures that govern learning allow for the emergence of unique individual adaptive processes that tend to emphasize some adaptive orientations over others” (p. 62). The idea of learning styles describes the individual difference in learning based on the person’s preference for the different modes of learning—CE, RO, AC, and AE. Each individual’s “hereditary equipment,” particular life experiences, and the current demands of any situation catalyze the development of a preferred way of choosing among the four learning modes.

ELT argues that an individual’s learning style is, “not a psychological trait, but a dynamic state resulting from synergistic transactions between the person and the environment . . .” (Kolb, 2009, p.315). Kolb (1984) stated that,

The stability and endurance of these states in individuals comes not solely from fixed genetic qualities or characteristics of human beings: nor, for that matter, does it come from the stable fixed demands of environmental circumstances. Rather, stable and enduring patterns of human individuality arise from consistent patterns of transaction between the individual and his or her environment. (p. 63)

Research on ELT has focused on the concept of learning styles, specifically Kolb’s Learning Style Instrument (KLSI) (Kolb, 2007). Though only four learning styles were proposed originally (Kolb, 1984), the instrument has now been expanded to nine to better describe various learning preferences (Kolb & Kolb, 2005b; Kolb & Kolb, 2009; Figure 2). Four of these style

types emphasize one of the four learning modes: Experiencing (CE), Reflecting (RO), Thinking (AC), and Acting (AE). Four other learning styles emphasize two of the learning modes, one from the grasping dimension and one from the transforming dimension: Diverging (CE and RO), Assimilating (AC and RO), Converging (AC and AE), Accommodating (CE and AE). The final style type represents a balance of each learning mode – Balancing (CE, RO, AC, and AE).

In 1991, Boyatzis and Kolb made a distinction between learning styles and learning skills. Though studies show that learning styles vary over short periods of time (Sims & Veres, 1989), data (Kagan, 1989) suggests that learning styles maintain a longer, more stable nature. In contrast, skills are developed by learning from experience and, as a result, are more variable and subject to intentional personal development. A learning skill is defined as, “a combination of ability, knowledge, and experience that enables a person to do something well within a specific situation and is subject to intentional development” (Boyatzis & Kolb, 1995, p. 2). The focus on learning skills led to the development of the Learning Skills Profile (LSP) instrument.

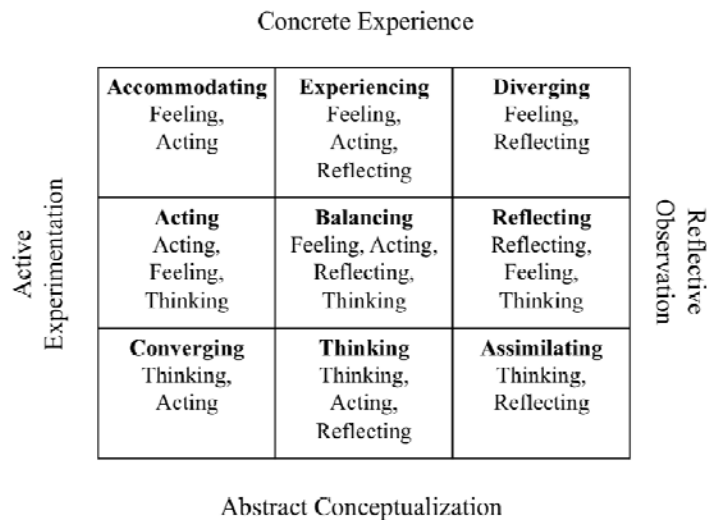
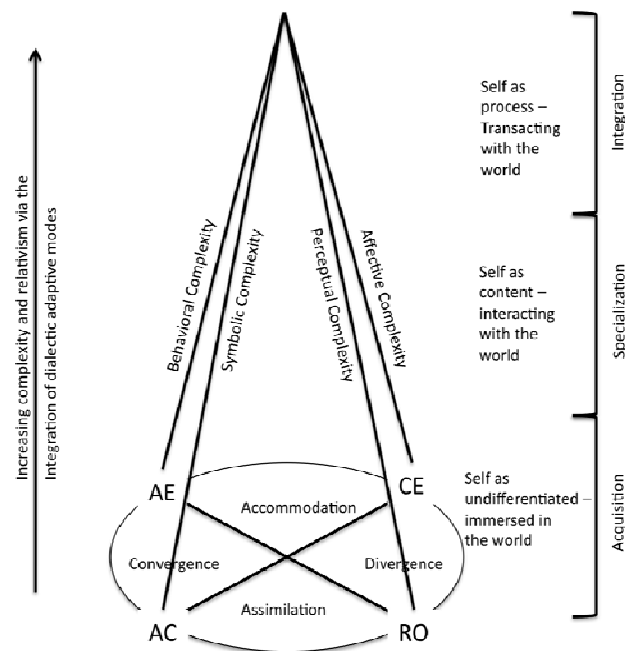

Figure 2. The Nine-Region Learning Style Type Grid. Adapted from “The learning way: Metacognitive aspects of experiential learning,” by Kolb, A., & Kolb, D. A., 2009, *Simulation Gaming*, 40, 297-327. Copyright 2008 by Sage Publications.

The LSP instrument correlates each of the learning modes of ELT to a job-related skill type. Divergent knowledge is represented by interpersonal skills. Assimilative knowledge is represented by information skills. Convergent knowledge is represented by analytical skills. And, accommodative knowledge is represented by action skills (Boyatzis & Kolb, 1991). Because learning skills can be developed intentionally, the concept of human development is important in order to understand ELT more fully. Kolb (1984) posited that, “the experiential learning theory of development focuses on the transaction between internal characteristics and external circumstances, between personal knowledge and social knowledge. It is the process of learning from experience that shapes and actualizes developmental potentialities” (p.133).

The ELT of Growth and Development (Figure 4) begins with development in each of the four modes of learning. Affective complexity in concrete experience leads to higher-order sentiments, perceptual complexity in reflective observation results in higher-order observations, symbolic

complexity in abstract conceptualization results in higher-order concepts, and behavioral complexity in active experimentation results in higher-order actions. The model of development is depicted as a cone with the base representing the lower levels of development and the apex representing the peak of development. The cone highlights the idea that, as a person develops, the four modes of learning become more integrated and complex.



*Figure 3. The Experiential Learning Theory of Growth and Development. Reprinted from *Experiential Learning: Experience as the Source of Learning and Development* (p. 141), by David A. Kolb, 1984, Englewood Cliffs, NJ: Prentice-Hall, Inc. Copyright 1984 by Prentice-Hall Inc. Reprinted with permission.*

Further, the developmental process is broken down into three major stages—acquisition, specialization, and integration. These stages relate to maturational stages that occur in humans as described by Piaget. Three forms of consciousness, referred to as performance, learning, and development, govern each level. Kolb (1984) noted that, though the three levels of development appear linear, each individual will progress through the levels at different rates and that many sub-levels based on each individual learner exist.

Objective 2: Apply ELT in the context of agricultural education

To address this objective, a personal interview with David A. Kolb was conducted. As such, David A. Kolb posited that experiential learning must 1) encompass each of the three components of the agricultural education model, 2) require support from the instructor purposeful, 3) lead to the development of important meta-cognitive skills, and 4) require curriculum planning and assessment intentionally.

Theme: Experiential Learning Must Encompass Each of the Three Components of the Agricultural Education Model

Kolb reported that the experiential learning model, when placed around the agricultural education model, illustrates the total learning experience of agricultural education.

Kolb asserted that, “agricultural education has a great advantage in that the entire program is so easily experiential” (465). He advocated that more education should be occurring outside of the classroom because classrooms are some of the most sterile environments imaginable. Although SAEs have been referred to as the experiential component of the agricultural education model traditionally (McLean & Camp, 2000), Kolb believed that each of the three components included in the agricultural education model must be experiential in nature. He suggested that the experiential learning cycle provides a good framework to compliment the existing agricultural education model. In fact, when presented with the comprehensive agricultural education model (i.e., three-circle Venn diagram), Kolb quickly connected each of the three components to the experiential learning cycle. He asserted that,

The formal instruction seems to be more related to the abstract, where FFA is more of the concrete and reflective part. The supervised experience is more the field project or the whole achievement converging aspect. In general, [agricultural education teachers] are covering a lot of the learning emphasis on the different modes of the learning cycle. (371)

When asked specifically about the role of SAE, Kolb explained that a direct connection between what is being taught in the classroom and the student’s SAE project is insignificant. What is most important, however, is allowing students to identify an area of interest or passion and assisting them in building a project around that. Once student interest is achieved, an instructor can deliver content in the formal setting of the classroom in a way that helps students transfer learning from one experience to another (i.e. SAE and classroom). He stated,

There is meta-learning that is going on there about how to solve problems on your own, and how to implement a plan and so on. That is kind of independent of what the project is about. So, on this kind of ‘learning how to learn’ template, if the raising of cattle project goes well, it can be transferred to raising corn in terms of those meta-skills. (400)

Kolb explained that teachers begin to see meta-skills emerge as students are provided opportunities to take personal responsibility in achieving the goals of a project over time. As such, Kolb posited that the purpose of the SAE should be to build student interest and develop important meta-skills—both of which support the classroom and FFA components.

Theme: Experiential Learning Must Require Purposeful Support from the Instructor

Kolb reported that the teacher must be present and mindful throughout the experiential process in order to guide and direct the learning. The instructor is called to connect with students’ prior knowledge and play different roles during each phase of the experiential learning model.

When asked how agriculture teachers can capitalize on the experiential nature of agricultural education, Kolb shared that,

It is important to really work with teachers to have them realize the importance that students are learning all the time. These are principles of experiential learning – that

you're learning all the time, and that their role as a teacher is to capitalize on the experiences they are having and help them reflect together about them and make sense about them. They [experiences] are very useful ways of helping with the personal development and moral development of students. (465)

Kolb posited that all learning is experiential and that even sitting in a classroom and listening to a lecture is an experience – and sometimes a very powerful one. He shared that, “the term experiential learning is redundant. Learning is the concept that talks about how experience changes people” (621). However, the experience itself does not constitute learning. Rather, the learner must reflect, draw abstractions, and experiment actively using the newly constructed knowledge in order for the transformation of learning to occur.

Kolb believed strongly that, “when [the teacher] connects to the students’ prior knowledge, and to their interest, the learning is more enduring and there is more of it” (546). One of the primary goals of an educator must be to start with the student’s understanding, and build on that. Kolb explained that educators tend to over-structure experiences. He stated that teachers must provide adequate learning space for students to experience and connect to their personal interest, and that it is important for teachers to be, “mindful of how students are making sense of what they’re looking at” (167). Kolb shared that it is critical that the teacher be present for these experiences in order to serve as a constant “gentle guide” (180) to help students construct meaning.

All students and teachers have a preferred learning style. Teachers tend to teach in a way that is consistent with their preferred style. Kolb noted that, “learning can really start anywhere, but to have a full learning cycle, it is important to go through all the learning modes, in some way or the other, not necessarily in order” (116). In fact, “instructors should teach around the cycle, and to teach all learning modes at some point in the curriculum” (86).

Kolb asserted that one of the biggest disconnects in the use of experiential learning is the missing connection between the teacher and the experience. The instructor plays an important role during each phase of the learning cycle.

From concrete experience to reflection, the teacher’s role is facilitator. They are drawing out the student and their interest, and then from reflection to abstraction, the teacher’s role is subject expert – making the connection between what they have experienced and observed and the concepts [the teacher] wants to teach. And then from abstraction to action, the teacher’s role is evaluator or standard setter sharing with students the goals you need to achieve and the ‘right’ answers so to speak. From action up to experience again, it is a coach that is applying the knowledge back into your experience. It requires a coaching perspective in which the teacher stands back and watches what the person does and helps them do it better. (226)

Theme: Experiential Learning Must Lead to Meta-Cognitive Skill Development

Kolb reported that teaching and developing meta-cognitive skills supports both the learning process and the overall growth of students.

Kolb asserted that, “As an educator, [a teacher] has at least two goals. One is to teach people the content, and the other is to teach them how to learn it” (74). One way to do that is to focus on

meta-cognition as a component of the curriculum. Kolb suggests using the KLSI as a platform for discussing how each student learns. He stated, “the more [students] know about learning, the better” (811). If students are challenged to move through all four learning modes in the experiential learning model, they are constantly building their meta-cognitive abilities.

When asked how agricultural education can validate the effect meta-cognition has on students, Kolb shared that, “one way to do that is to focus, in terms of your outcome evaluations, not just on the concepts or ideas – learning the material, but also in measuring meta-cognitive or ‘meta level’ skills that they are developing” (734). He noted planning, goal setting, persistence and self-direction as examples of meta level skills. Kolb mentioned the more detailed list of meta-skills are noted and assessed in the Learning Skills Profile (LSP).

Theme: Experiential Learning Must Require Purposeful Curriculum Planning & Assessment

Kolb reported that experiential learning curriculum, when properly designed and executed, can have positive effects on both formal and informal assessments.

Kolb suggested that, “there is evidence to support the idea that experiential learning produces results that are better than traditional educational models” (537). This assertion was supported through the mention of studies (Ash & Clayton, 2004; Eyler & Giles, 1999; Eyler & Halteman, 1981; Steinke & Buresh, 2002; Steinke & Fitch, 2003) that have examined the effectiveness of experiential learning on knowledge retention in a number of domains.

Kolb emphasized that experiential learning can be goal-oriented and standards-based. He conceded that, “[educators] have objectives that need to be communicated” (200). He referred to the instructor’s role as an evaluator who should direct students to specific targeted content. However, Kolb shared his concern that, “[standards] are driving a lot of things. It can very easily drive it too much to the point where students are able to master and do [well] on the test, but they will totally forget it because it is totally irrelevant to their life and their goals” (208).

Kolb used the example of a civics standard focusing on an understanding of Lake Erie to illustrate the marriage of standards and experiential learning. He stated that the curriculum would include a concrete experience, which could include a trip to the lake, a video, or a guest speaker. This experience would then be reflected on purposely through journals that noted what individual students found interesting. Following that reflection, the teacher would make conceptual material available about the targeted information in the lesson guiding students gently to the intended learning outcomes. Finally, students would apply some kind of action application based on what they learned. This might take the form of a beach clean up day or informational school presentation which correlates with a curriculum goal or objective upon which learning activities are planned around the learning cycle” (105).

In terms of assessment, Kolb suggested that students write an essay about the trip in order to identify if the intended goal was achieved. He also shared that teachers could use an objective assessment. Though experiential learning may be more time and effort intensive, Kolb asserted that it produces richer, more enduring learning.

Implications for the Overlay of Kolb’s Experiential Learning Theory on a Comprehensive Agricultural Education Model

Objective 3: Enrich the current model of agricultural education to include the role of experiential learning more purposefully.

Traditionally, educators believe SAE programs are the primary experiential learning tool (Benson, 1981; Warren & Flowers, 1992) in agricultural education. However, Kolb (1984) asserted that all learning is experiential. Thus, experiential learning plays an integral role in the entire agricultural education model – not just the SAE component.

Croom (2008) concluded, “for the [agricultural education] model to be successful to a significant degree, there must be a commitment by all stakeholders to deliver all components collectively” (p. 118). Lewin shared that, “There is nothing so practical as a good theory.” To that end, the following model (Figure 4) was proposed in order to operationalize the role of experiential learning further in relation to agricultural education. The purpose was not to propose a new model for agricultural education, but rather to enrich the current one. It is the hope of the researchers that their work can be additive and useful to secondary agricultural teachers as a means of justifying the nature of their jobs (i.e., teaching in an experiential manner).

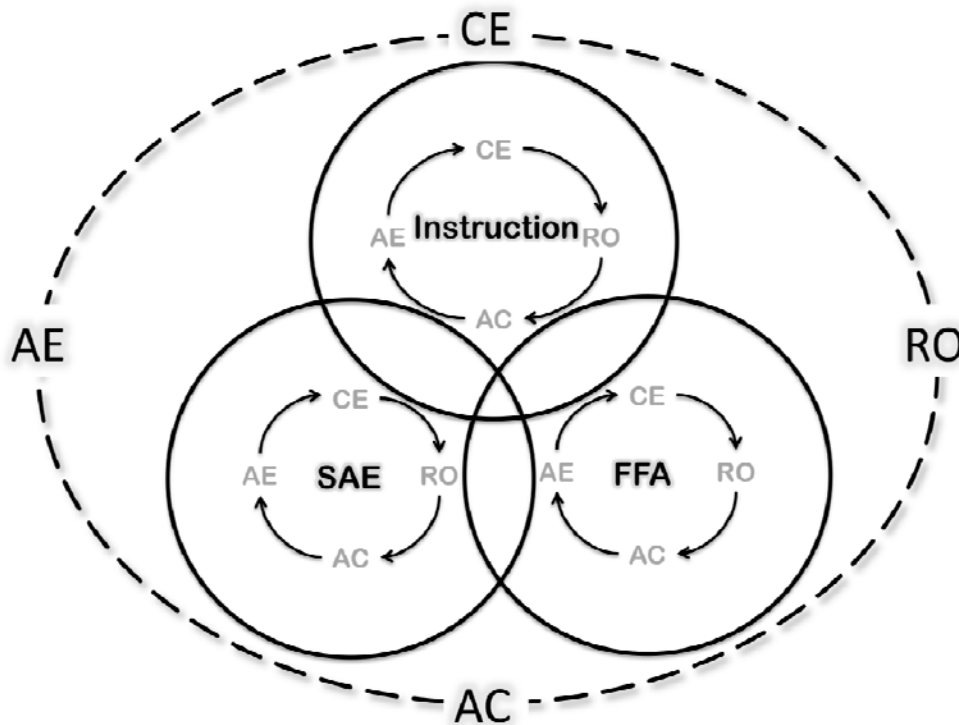

Figure 4. Enriched Agricultural Education Model

At the core of the model is the idea that the experiential learning cycle is embedded in each of the three circles. Phipps, Osborne, Dyer, and Ball (2008) suggested three questions that should follow any concrete experience: What happened?; So what do I conclude?; and Now what do I do? These questions are fundamental in guiding instruction experientially. As such, students should be provided the opportunity to choose an area of interest, engage in concrete experiences,

think about those experiences, build abstract concepts with the aid of their instructor, and utilize the learning as they continue to actively experiment. For example, if a student has chosen to exhibit a steer, they must have the opportunity to groom that animal on their own. Following that experience, they should reflect by asking, “what happened?” With help from their advisor, they would then develop abstract concepts around the grooming process, and try it again with the newfound knowledge.

Classroom and laboratory experiences, including guest speakers, research projects, science experiments, greenhouse or school farm work, and group projects provide the impetus for the experiential learning process. Students should reflect on the knowledge provided by their instructor, connect that reflection to abstract academic concepts, and experiment actively with that knowledge in new contexts. As Kolb discussed, experiential instruction can be directed and standard-focused through the instructor’s role as evaluator during the abstract conceptualization phase. As discussed earlier, it does not matter where instruction begins on the cycle, so long as students are exposed to all four modes of learning.

In order to maximize learning from FFA experiences, students must also pass through each of the learning modes. For example, the National FFA Convention may serve as a powerful concrete experience. However, it is critical that students reflect on that experience, whether through group discussions, a daily journal, or another method. Those reflections will lead to abstract concepts. As students return to their local chapter, they will have the opportunity to experiment actively with their newfound concepts.

An important component to this model is learning/development “space” as described in Bronfenbrenner’s (1977, 1979) work on the ecology of human development. Bronfenbrenner defines the ecology of learning/development spaces as a topologically nested arrangement of structures, each contained within the next. A learner’s microsystem includes their immediate setting while the macrosystem refers to overarching institutional patterns and values the wider culture. The proposed model contains a student’s microsystem, contained within the three inner circles, and macrosystem depicted with a dotted line surrounding the entire three-circle model. The macrosystem, in the proposed model, is not static, but rather is constantly moving as a student progresses through various aspects of agricultural education, and represents the more holistic, long-term experience of agricultural education.

Conclusion

This study concluded that agricultural education is uniquely poised to help students through an effective model of instruction that is experiential by nature. However, simply providing experiences does not constitute learning. As suggested by Roberts (2006), educators must fully understand ELT in order to effectively operationalize the core concepts during instruction. It is imperative that experiences provided in agricultural education, from the show ring to the laboratory activity, and from the state convention to the chapter banquet, include purposeful reflection, gentle guiding towards abstraction, and an opportunity for students to experiment actively with their new found learning. Too often, a myriad of concrete experiences are offered, but a lack of purposeful processing allows valuable meaning to be lost. Though this process may take more time and effort, Kolb asserted that the result is more enduring and relevant learning.

Teachers must be present and purposeful in order to properly support experiential learning. Learning outside of the classroom can have value, but teachers must remain focused on the fact that a key tenant of experiential learning is that students are learning, and not just enjoying an experience. Knobloch (2003) posited, “one of the greatest challenges for today’s teachers and students of agriculture is to move beyond the ‘doing’ and ensure that all learning is connected to thinking and knowledge that will be easily remembered and applied later in life” (p. 31). According to Kolb, teachers who desire to implement the learning cycle must be facilitators, experts, evaluators, and coaches. It is important that the instructor begins with the student’s interests in order to be mindful of how students make meaning of what they experience.

Experiential learning builds meta-cognitive skills. As such, an important part of learning should always be learning how to learn, and the KLSI can support teachers in that process. Students should be provided the opportunity to understand how they learn and the process involved in making meaning of experiences. These experiences should be goal-oriented and assessed. Today, more than ever, standardized tests and specific standard-based curriculum are the focus of schools. Curriculum designed experientially cannot focus on targeted goals only, but can also lead to more academic success for students. According to Kolb, educators must be careful to not over structure instruction to the point where concepts become completely irrelevant and are not retained by students. Congruent to this idea, Knobloch (2003) asserted that, “Agricultural educators who engage students to learn by experience through authentic pedagogy will most likely see the fruits of higher intellectual achievements, not only in classrooms and schools, but more importantly, in their roles as adults as contributing citizens of society” (p. 32).

Recommendations for Practice

The following recommendations for practice are made:

1. Professional development should exist to prepare agricultural educators to process experiences better in each of the three components of the agricultural education model.
2. Pre-service agricultural education programs should utilize the enriched agricultural education model proposed in this study to emphasize the role of experiential learning in all aspects of agricultural education.
3. Pre-service agricultural education programs should integrate the KLSI into the curriculum in order to build an awareness of teacher’s preferred learning style.
4. Teachers should integrate meta-cognition into their existing curriculum to help students learn how they learn.
5. Teachers should assist students in developing meta-skills such as planning, goal setting, persistence and self-direction in an effort to increase their meta-skills per the LSP.
6. Assessments should be developed to equip agricultural educators better in evaluating student experiences objectively (i.e. rubrics for reflection and authentic and performance assessments).

Recommendations for Future Research

Kolb stated that, “there is a lot more research needed to support [the effectiveness of experiential education] and to show effectiveness in systematic ways” (565). Quasi-experimental studies should be conducted to determine the effect experiential learning has on students’ learning and the retention of that knowledge. Future research should exist that compares students who encounter a series of experiences in agricultural education to those who learn the same concepts

in a lecture-based format. Then, after the intervention concludes, retention of knowledge should be measured to determine the long-term impacts of experiential learning on student memory. Another important question to be investigated is to what extent are meta-skills learned across the three components of the agricultural education model? The answers to this question hold implications for the “value” of agricultural education “writ large.” Which part of the comprehensive model is most impactful to students in regard to learning and acquiring important meta-skills? Research should exist to measure this phenomenon.

References

- Ash, S. L., & Clayton, P. H. (2004). The articulated learning: An approach to reflection and assessment. *Innovative Higher Education, 29*, 137–154.
- Benson, P. W. (1981). *Comparison of affective work competencies and selected background experiences of students, graduates, and supervisors in agricultural mechanization*. Dissertation Abstracts International, 42, 59A.
- Boyatzis, R. E., & Kolb, D. A. (1991). Assessing individuality in learning: The learning skills profile. *Educational Psychology, 11*(3-4), 279–295.
- Boyatzis, R. E., & Kolb, D. A. (1995). From learning styles to learning skills: The Executive Skills Profile. *Journal of Managerial Psychology, 11*(1), 3–17.
- Bronfenbrenner, U. (1977). Toward an experimental ecology of human development. *American Psychologist, 32*, 513–532.
- Bronfenbrenner, U. (1979). *The ecology of human development*. Cambridge, MA: Harvard University Press.
- Carver, R. (1996). Theory for Practice: A framework for thinking about experiential education. *Journal of Experiential Education, 19*(1), 8–13.
- Cheek, J. G., Arrington, L. R., Carter, S., & Randall, R. S. (1994). Relationship of supervised agricultural experience program participation and student achievement in agriculture. *Journal of Agricultural Education, 35*(2), 1–5.
- Croom, D. B. (2008). Development of the integrated three-component model of agricultural education. *Journal of Agricultural Education, 49*(1), 110-120. doi: 10.5032/jae.2008.01110
- Dewey, J. (1897). My pedagogic creed. *The School Journal, LIV*(3), 77–80.
- Dewey, J. (1938). *Education and experience*. New York: Simon and Schuster.
- Dooley, K. E. (2007). Viewing agricultural education research through a qualitative lens. *Journal of Agricultural Education, 48*(4), 32–42.

- Edgar, L.D., Briers, G. E., & Rutherford, T. (2008). Research themes in agricultural education: Future gap analysis of the National Research Agenda. *Journal of Southern Agricultural Education Research*, 58(1). Retrieved from <http://pubs.aged.tamu.edu/jsaer/pdf/vol58/58-01-061.pdf>.
- Eyler, J. (2009). The power of experiential education. *Liberal Education*, 95(4), 24–31.
- Eyler, J., & Giles Jr., D. E. (1999). *Where's the learning in service learning?* San Francisco, CA: Jossey-Bass.
- Eyler, J., & Halteman, B. (1981). Socialization for political participation: The impact of legislative internship on students' political skillfulness and sophistication. *Teaching Political Science*, 9(1), 27–35.
- Hughes, M., & Barrick, R. K. (1993). A model for agricultural education in public schools. *Journal of Agricultural Education*, 34(3), 59–67.
- Itin, C. M. (1999). Reasserting the philosophy of experiential education as a vehicle for change in the 21st century. *Journal of Experiential Education*, 22(2), 91–98.
- Kayes, D. C. (2002). Experiential learning and its critics: Preserving the role of experience in management learning and education. *Academy of Management Learning and Education*, 1(2), 137–149.
- Knapp, D., & Benton, G. M. (2006). Episodic and semantic memories of a residential environmental education program. *Environmental Education Research*, 12(2), 165–177. doi: 10.1080/13504620600688906
- Kolb, D. A. (1984). *Experiential learning: Experience as the source of learning and development*. Upper Saddle River, NJ: Prentice Hall.
- Kolb, A., & Kolb, D. A. (2005a). *Experiential learning theory bibliography*. Experience Based Learning Systems, Inc. Cleveland, OH. Retrieved from www.learningfromexperience.com.
- Kolb, A., & Kolb, D. A. (2005b). Learning styles and learning spaces: Enhancing experiential learning in higher education. *Academy of Management Learning & Education*, 4(2), 193–212.
- Kolb, D. A. (2007). *The Kolb learning style inventory—Version 3.1: LSI workbook*. Boston: Hay Learning Transformations.
- Kolb, A., & Kolb, D. A. (2009). The learning way: Meta-cognitive aspects of experiential learning. *Simulation Gaming*, 40, 297–327. doi: 10.1177/1046878108325713

- Knobloch, N. A. (2003). Is experiential learning authentic? *Journal of Agricultural Education*, 44 (4), 22–34.
- Lewin, K. (1951). *Field theory in social science: Selected theoretical papers*. New York, NY: Harper & Row.
- McLean, R. C., & Camp, W. G. (2000). An examination of selected agricultural teacher education programs in the United States. *Journal of Agricultural Education*, 41(2), 23–35.
- Merriam, S. B. (1995). What can you tell from an N of 1?: Issues of validity and reliability in qualitative research. *PAACE Journal of Lifelong Learning*, 4, 51–60.
- Merriam, S. B. (1998). *Qualitative research and case study application in education*. San Francisco: Jossey-Bass Inc.
- Patton, M. Q. (2002). *Qualitative research & evaluation methods (3rd ed.)*. Thousand Oaks, CA: Sage Publications Inc.
- Phipps, L. J, Osborne, E. W., Dyer, J. E., & Ball, A. (2008). Theoretical foundations of effective teaching (6th ed.), *Handbook on agricultural education in public schools* (pp. 177 – 195). Clifton Park, NY: Thomson Delmar Learning.
- Ramsden, P. (1997). *The context of learning*, in: F. Martin, D. Hounsell, & N. Entwistle (Eds). *The experience of learning: Implications for teaching and studying in higher education* (Edinburgh Scottish Academic Press).
- Randall, R. S., Arrington, L. R., & Cheek, J. G. (1993). The relationship of supervised agricultural experience program participation and student achievement in practical skills in agricultural science. *Journal of Agricultural Education*, 34(1), 26–32.
- Roberts, T. G. (2006). A philosophical examination of experiential learning theory for agricultural educators. *Journal of Agricultural Education*, 47(1), 17–29.
- Steinke, P., & Buresh, S. (2002). Cognitive outcomes of service-learning: Reviewing the past and glimpsing the future. *Michigan Journal of Community Service Learning*, 8, 5–14.
- Steinke, P., & Fitch, P. (2003). *Using written protocols to measure service-learning outcomes*. In S. H. Billig & J. Eyler (Eds.), *Deconstructing service-learning: Research exploring context, participation and impacts* (pp. 171-194). Greenwich, CT: Information Age Publishing.
- Stewart, B. R., & Birkenholz, R. J. (1991). Outcomes of changing supervised agricultural education programs. *Journal of Agricultural Education*, 32(3), 35–41.

Warren, R. J., & Flowers, J. (1992, December). *The relationship between the quality of the supervised agricultural experience component of the secondary agriculture program in North Carolina and the instructors' levels of time management*. Paper presented at the Nineteenth Annual National Agricultural Education Research Meeting, St. Louis, MO.

Effects of Inquiry-based Agriscience Instruction on Student Argumentation Skills

*Andrew C. Thoron, Assistant Professor, University of Illinois at Urbana-Champaign
Brian E. Myers, Associate Professor & Associate Chair, University of Florida*

Abstract

The purpose of this study was to determine the effect of inquiry-based agriscience instruction on student argumentation skills. Argumentation is defined as the student's ability to establish a claim, provide a rationale for steps taken, provide and justify data, recognize alternate conclusions, and provide evidence why the conclusion is correct or the best solution. Developing argumentation skills can aid in developing the next generation of scientists and help individuals, who are not scientists, distinguish evidence from bias. This quasi-experimental study investigated the effect of two teaching methods on student argumentation skills. Inquiry-based instruction was compared to the subject matter approach in 15 agriscience education classes found within seven different secondary schools across the United States. Utilizing univariate analysis of covariance, there was a statistically significant difference between groups on argumentation skills. Those students taught through inquiry-based instruction were reported as having higher argumentation skill than students taught through the subject matter approach.

Introduction

Research has indicated that the amount of student learning that occurs in a classroom is directly proportional to the quality and quantity of student involvement in the educational program (Cooper & Prescott, 1989). Chiasson and Burnett (2001) reported that agricultural education helped connect student involvement in content, citing a greater gain in science scores. However, high school teachers dominate classroom conversation, consuming nearly 70% of classroom time (Cooper & Prescott). Inquiry-based instructional approaches reverse this trend, placing students first in the learning process and teachers in the role of learning facilitator. The facilitating teacher manages interactions and keeps teams focused on progress encouraging students to work toward answering the overall learning outcomes set forth through their plan of action (Cooper & Prescott). The NRC (1996, 2000) defined scientific inquiry as the study of the natural world and explanations that are based on evidence. Furthermore, Anderson (2002) argued that scientific inquiry is the ability to understand and support investigations with evidence. In addition, Keil, Haney, and Zoffel (2009) stated inquiry-based instruction contains multiple dimensions of teaching and learning and leads learners to develop deeper understandings while connecting content knowledge to solving a situation.

Explanations of results and conclusions based on evidence, when students are taught through inquiry-based instruction, leads to a need to investigate tools that take into account (measure) the students' ability to produce evidence-based claims, form conclusions, and supply recommendations based on their understanding of the investigation. Investigation of argumentation skills is the study of logic, and producing correct inferences based on a given context (Driver, Newton, & Osborne, 2000). At first glance, the term argumentation may lead one to believe individuals will verbally argue their point-of-view in a heated exchange. While an argument between individuals can exist, argumentation skills is the development of logical

explanations and categorization of opposing assertions, weights of evidence, and determination of merit for each assertion with regard to evidence (Kuhn, 1992). Argumentation skills can be expressed through writing or discussion (Driver, Newton, & Osborne).

Rogers (1948) stated that student contact alone with science does not develop the ability to think critically. In pointing out the need for argumentation skills, Schwab (1962) argued that science education is nearly a presentation of conclusions that are taught as empirical and absolute truth – a simple unproblematic collection of facts (Geddis, 1991). Claxton (1991) described that the way teachers are taught to present science does not reward rebuttals based on one's scientific reasoning. While facts are important to know, and some unquestioned scientific concepts exist, scientists assess alternatives, consider evidence, interoperate text, evaluate the appropriateness of design, and discriminate conclusions when formulating their final analysis and arguments (Latour, & Woolgar, 1986). Baron (1991) and Cerbin (1988) stated that a pure traditional teaching creates learners that lack the ability to develop arguments with adequate evidence. Furthermore, Norris and Phillips (1994) indicated students are not encouraged to argue their strengths and weaknesses and called for the science education community to focus on argumentation skills.

Kuhn (1992) conducted a study on argumentation of 160 individuals ranging from ninth grade students through adult. Kuhn determined that individuals of all ages use false claims and weak arguments to present their beliefs. The development of argumentative practice is foundational to scientists and is “essential to enhance the public understanding of science...” (Driver, Newton, & Osborne, 2000 p. 287). Kuhn determined that individuals with low argumentation skills simply dismiss factors as irrelevant if findings do not support their point of view. Several studies indicate that students have difficulty distinguishing between evidence and bias (Baron, 1991; Perkins, Farady, & Bushey, 1991; Toplak & Stanovich, 2003). As the society of the United States becomes less aware of the food and fiber industry, this may present a serious threat to production practices.

Jimenez-Aleixandre, Bullgalo-Rodriguez, and Duschl (1997), in a study of high school discussion groups that utilized genetics problems as the context, found that students had difficulty incorporating claims and scientific evidence. Jimenez-Aleixandre et al. determined that the traditional science classroom does not regularly provide context for the construction of students' ability to develop argumentation skills. Zohar and Nemet (2002) conducted an experimental study on the topic of human genetics with ninth grade students, one group utilizing traditional methods (control) and the other an interactive curriculum. Zohar and Nemet found that the treatment group was able to transfer reasoning abilities through the context of genetics to everyday life applications. Additionally, the treatment group referred to correct, biological evidence through argumentation at an increased frequency when compared to the control group.

Development of argumentation skills of students has been examined in an educational context. However, previous studies focused on the development of argumentation skills, few studies examine a teaching method's affect on student argumentation skills. Based on evidence in the literature, an agriscience student that has greater argumentation skills will create more thoughtful science-based arguments (Kuhn, 1993). In summary, it can be posited that the development of argumentation for agriscience students will lead to more thoughtful evidence-based answers for

citizens unaware of how the food and fiber industry operates. Additionally, agriscience students not seeking a career opportunity in agriculture will be able to make educated decisions based on the scientific arguments of the agricultural industry.

Theoretical/Conceptual Framework

Constructivism is the guiding philosophical perspective used in this study. The constructivist approach to teaching and learning has been highlighted in research and in practice in numerous educational contexts (Bransford, Brown, & Cocking, 2000; Hamlin, 1992; Lampert, 1992; Myers & Dyer, 2006; Newcomb, McCracken, & Warmbrod, 1993; NRC, 2000; Phipps, Osborne, Dyer, & Ball, 2008; Schunk, 2004). Schunk stated (p. 285), "...the rise of constructivism has been theory and research in human development, especially the theories of Piaget and Vygotsky." As an epistemology, constructivism is concerned with the role of the learner and teacher as a facilitator. Constructivism incorporates cognitive theories that place emphasis on learners' information processing as a central cause of learning, yet constructivism digs deeper to capture the complexity of human learning (Schunk). Constructivism shifts the focus from "how knowledge is acquired" to "how it [knowledge] is constructed" (Schunk, p. 285). Piaget's Theory of Cognitive Development (1972) and Vygotsky's Sociocultural Theory (1978) combined to form the theoretical basis for the study from a constructivist philosophical perspective.

The model for this study (Figure 1) depicts the interactions that occur in an inquiry-based classroom. Because this study is part of a larger study, there was more than one outcome investigated. Static attributes were variables that would be collected during the investigation, and the teaching and learning process describe the inquiry-based process.

Figure 1. Theoretical model for the effects of inquiry-based instruction.

Purpose/Objectives/Hypotheses

The purpose of this study is to determine the effects of teaching method on student argumentation skills of high school agriscience students. The specific objectives guiding the study were to:

1. Describe the population of the study.
2. Ascertain the effects of inquiry-based instruction on argumentation skills of high school agriscience students.
3. Examine the relationship between argumentation skills, ethnicity, gender, year in school, and socio-economic status of high school agriscience students.

The null hypothesis, H_0 : no significant difference in student argumentation skills based upon the teaching method (inquiry-based teaching or subject matter approach), guided the analysis of the second objective.

Methods

The population of this quasi-experimental design was composed of students at ten high schools offering agriscience education in the United States ($N = 437$). The accessible population was students of the National Agriscience Teacher Ambassador Academy (NATAA) participants. A purposive sample was selected according to the ability of the teacher to utilize the integrated agriscience curriculum and inquiry-based instruction and subject matter approach to teaching.

The content and context of the lessons for both the subject-matter and inquiry-based lessons were deemed appropriate by a panel of experts. Seven units of instruction that addressed the soil and plant science portion of the National Agriscience Content Standards for an agriscience course in the United States (CAERT, 2008) were selected by the researcher from the Animal, Plant, and Soil Science curriculum developed by Center for Agricultural and Environmental Research and Training, Inc. (CAERT). The instructional plans were evaluated for content validity by a panel of experts from the Agricultural Education and Communication Department and the School of Teaching and Learning at the University of Florida. The panel determined that the inquiry-based and subject matter lessons were suitable for the grade levels and deemed the lessons appropriate.

The independent variable in this study was the teaching method used in the agriscience classes. Intact treatment groups were randomly selected to receive either inquiry-based instruction or the subject matter approach to learning. The dependent variable in this study was student argumentation skill. The greatest threat in this design type is that the differences found in the posttest are due to preexisting group differences, rather than due to the treatment (Gall, Borg, & Gall 1996). The use of multiple classroom settings in this study reduced the risk of interaction of subjects, and the use of pretests of content knowledge addressed these concerns.

To ensure that teachers involved in this study were exhibiting the correct teaching methodology, teachers were asked to audiotape each class period during the duration of the study. The Science Teaching Inquiry Rubric (STIR) (Bodzin & Cates, 2002) was used to analyze the level of inquiry-based instruction. The STIR has been reported to have an overall correlation of $r = .58$ with a perfect correlation between two raters of $r = 1.00$, establishing the STIR as an effective analysis tool (Bodzin & Beerer, 2003). The researcher determined *a priori*, based on a study conducted by Thoron and Myers (2009), that students missing more than 25% of the instructional time during the study would be removed. Additionally, students that did not receive the treatment effectively would be removed from the sample.

All students were administered a pretest to establish a base line before each of the seven replications to measure content knowledge levels in the subject matter to be taught (soil and plant science). All sections were taught the same content by the same teacher and according to their randomly assigned group were taught with the same teaching method the entire twelve weeks (inquiry or subject-matter). Pretest instruments were developed by the researcher using content knowledge questions in the form of multiple choice items. The instruments contained a specific number of questions based on the determined percentage of time to be spent teaching each objective of the unit. The testing instruments were validated by a panel of agriscience education and inquiry education experts. Prior to the study a coefficient alpha for the dichotomous data of the content knowledge achievement exams was calculated through a pilot test to assess reliability of the instruments (Campbell & Stanley, 1963). Reliability coefficients for the content knowledge achievement instruments were calculated using Kuder-Richardson 20 (KR20) for dichotomous data (Gall, Borg, & Gall, 1996). The seven instruments were determined to have a coefficient alpha of: .94, .93, .91, .86, .87, .89, and .91 respectively.

A scoring rubric developed by Schen (2007) was utilized in the assessment of student argumentation skills. The researcher scored each student response, assigning a score based on the

quality of the response in the categories of claim made, grounds used, warrants given, counterargument generated, and rebuttal offered. A panel of experts consisting of faculty from the Agricultural Education and Communication Department and the Educational Psychology Department at the University of Florida evaluated the rubric for face and content validity. The panel determined that the researcher-developed rubric was valid. After completion of the researcher-scored response, an expert selected a random sample (subject-matter and inquiry-based teaching) for a double blind review to obtain inter-rater reliability. The inter-rater reliability for the argumentation skills instrument reported a Cronbach's Alpha reliability coefficient of .81.

Findings

This study is part of a larger study conducted by the researcher. The results address the objectives and hypothesis of the study in determining the influence of teaching method, gender, ethnicity, social economic status, and year in school on student argumentation skills. Objective one sought to describe the population of the study. The total group consisted of $N = 437$ students from ten different schools across the United States. Three teachers opted out of the study noting health related issues or teaching reassignment. As a result of teachers being unable to deliver instruction, 109 students were removed from the study. Twenty-three students were removed from the study due to missing 25% or more of instruction.

Audio recordings of the administered units were scored using the STIR rubric (Bodzin & Cates, 2002) to determine the level of inquiry investigation by students in the inquiry-based treatment group and that inquiry was not being delivered in the traditional treatment group. It was determined that all seven teachers effectively delivered inquiry-based and subject matter instruction. After removal of participants unable to complete the study and students missing more than 25% of the instructional time, the original sample was reduced to $n = 305$. This equates to a 30.21% mortality rate for this study. Previous experimental studies in agricultural education using intact classes reported similar or higher mortality rates (Boone, 1988; Dyer, 1995; Flowers, 1986; Myers, 2004) and Jurs and Glass (1971) described mortality rates may be as high as 50%.

Participant ethnicity was categorized into the groups of White (non-Hispanic) ($n = 249$, 81.6%), Black ($n = 13$, 4.3%), Hispanic ($n = 31$, 10.2%), and Other ($n = 12$, 3.9%). The ethnicity of each of the treatments was similar to the ethnicity of the entire sample. The majority of the participants in this study (58.0%) were male. The treatment groups were similar to each other as inquiry-based instruction contained 57.6% male and subject matter (SM) contained 58.5% male participants. Inquiry-based instruction yielded 170 participants and subject matter contained 135 students.

Of the 305 participants who reported grade level data, 48.5% ($n = 148$) were in the ninth grade. The remainder of the participants were either in tenth grade ($n = 134$, 44.0%), or eleventh grade ($n = 23$, 7.5%). There were no twelfth-grade students in the study. Grade level distribution by treatment groups varied little from that of the overall sample. Slightly more than 50% of the students in the inquiry-based group were in the ninth grade as compared to approximately 45% in the subject matter group. Treatment groups were similar in terms of grade level.

Socio-economic status (SES) was determined by ability to participate in the national free and reduced school lunch program (Stone & Lane, 2003). Therefore, SES was categorized in the groups of non ability to participate, ability to receive reduced lunch, and ability to receive free lunch. The majority of the students participating in this study (n = 221, 72.5%) were not able to participate in the national school lunch program with 16.7% (n = 51) able to receive a reduced price in the school lunch program and the remainder (n = 33), 10.8% able to receive free lunch. Treatment groups were similar in terms of SES.

Objective two sought to ascertain the effects of inquiry-based instruction on argumentation skills of high school agriscience students. Each student's content knowledge achievement was determined using the researcher-developed content knowledge achievement instruments. The maximum possible score on these instruments was 100. Pretest data were collected from 305 participants (100%). Inquiry-based instruction treatment group achieved similar mean content knowledge scores and similar standard deviations as the subject matter treatment group (see Table 1).

The student argumentation skills instrument was used to determine the argumentation skills of students following the treatments (subject matter and inquiry-based instruction). The student argumentation skill ability of the participants was measured post-treatment using a rubric developed by Schen (2007). The response rate for the argumentation instrument was 86.2%. The overall mean score of the argumentation skill instrument was 5.97 (SD = 1.79) of a possible 10 (see Table 2). The mean argumentation score was higher for the inquiry-based instruction (M = 6.44, SD = 1.74) than for subject matter instruction.

Table 1. Participant Mean Pretest Scores (n = 305)

Content Knowledge Instrument	Treatment Group					
	IBI		SM		Total	
	<i>M</i>	<i>SD</i>	<i>M</i>	<i>SD</i>	<i>M</i>	<i>SD</i>
1	35.57	11.68	36.64	12.80	36.04	12.18
2	35.72	12.78	36.09	14.20	35.88	13.41
3	31.20	11.06	31.79	12.40	31.46	11.66
4	36.19	13.88	35.17	12.96	35.74	13.47
5	35.82	11.89	35.97	12.77	35.89	12.27
6	33.72	13.78	35.02	13.83	34.30	13.79
7	29.27	11.74	30.07	12.75	29.63	12.18

Note. IBI = Inquiry-based instruction; SM = Subject Matter

Table 2. Participant Mean Student Argumentation Skill Scores

Instrument	Treatment Group					
	IBI (n = 147)		SM (n = 116)		Total (n = 263)	
	<i>M</i>	<i>SD</i>	<i>M</i>	<i>SD</i>	<i>M</i>	<i>SD</i>
Student	6.44	1.74	5.39	1.68	5.97	1.79

Argumentation Skills

Note. IBI = Inquiry-based instruction; SM = Subject Matter

Objective three sought to examine the relationship between argumentation skills, ethnicity, gender, year in school, and socio-economic status of high school agriscience students. Prior to any inferential analysis of the data, all variables were examined for correlations. For the purpose of discussion, the terminology proposed by Davis (1971) was used to indicate the magnitude of the correlations. Pearson Product Moment correlations were used to determine the relationships between the variables (see Table 3). Negligible correlations between all variables were found with the exception of the correlation between treatment and argumentation skill score. The relationship between the argumentation skill score and treatment $r = -.30$ was found to be moderate.

Table 3. Correlations Between Variables

Variable	1	2	3	4	5	6
1. Argumentation Skills Score	--	-.03	-.16	-.05	-.14	-.30
2. Grade		--	-.03	-.04	-.06	.04
3. Gender			--	.03	.11	-.01
4. Ethnicity				--	.05	.01
5. SES					--	-.05
6. Treatment						--

Note. Treatment = Teaching method utilized

The null hypotheses states there is no significant different in student argumentation skills based on teaching method. Students' argumentation skill score was calculated by the use of Schen's (2007) rubric. Students taught using inquiry-based instruction achieved a higher mean argumentation skill score ($M = 6.44$) than students taught using the subject matter approach. The univariate analysis of covariance [$F(127) = 30.23, p \leq .001$] revealed significant differences in argumentation skills at the alpha level of .05 between students taught by the two teaching methods (see Table 4). Based upon these findings, the null hypothesis of no significant difference in student argumentation skills between the two groups was rejected.

Table 4. Univariate Analysis of Treatment Effects for Argumentation Skills

Source	<i>Df</i>	<i>F</i>	<i>p</i>
AS	2	30.23	$\leq .001$

Note. AS = Argumentation Skills

Conclusions

Based on the results of this study there are three conclusions.

1. **Demographics:** A majority (81.6%) of the students involved in this study were White, non-Hispanic. The majority (58%) of the students in the study were male. Nearly half (48.5%) of the students were in the ninth grade. The second largest grade level represented was the tenth grade (44%) followed by the remainder of the sample in the eleventh grade (7.5%). A majority of the students participating in the study did not

qualify for free or reduced lunch programs (72.5%), while just over one-quarter of the students were in a lower socioeconomic group. There were negligible variations across all the demographics for inquiry-based and subject matter treatment groups.

2. **Relationships of variables:** Student demographic variables reported low to negligible relationships with argumentation skill and treatment. However, treatment and argumentation skills had a moderate relationship.
3. **Argumentation skills:** Student scores were calculated by the use of Schen's (2007) rubric. Students taught using inquiry-based instruction achieved a mean score of 6.44 while students taught through the subject matter approach achieved a mean score of 5.97. Therefore, students in the inquiry-based instruction scored higher than students in the subject matter group. A univariate analysis of covariance revealed significant differences in argumentation skills at the alpha level of .05 between students taught by the two teaching methods thus the null hypothesis was rejected.

Discussion/Implications

The findings of this study support the work of Keil, Haney, and Zoffel (2009) that stated inquiry-based instruction contains multiple dimensions of teaching and learning and leads learners to think critically without being critical or concerned with arriving only at a correct answer. It can be concluded that inquiry-based instruction continues to focus on the ability to explain the process examined in the development of learner answers (Keil, Haney, & Zoffel). Furthermore, inquiry-based instruction seeks to capitalize on current student experiences and transfer those experiences to new learning situations (NRC, 2000).

It has been reported that learners have difficulty distinguishing evidence from bias/fairness (Baron, 1991; Perkins, Farady, & Bushey, 1991; Toplak & Stanovich, 2003). Using inquiry-based instruction can increase argumentation skills, which are a direct link to reasoning patterns and the ability to support their conclusions based on scientific data. The findings of Baron (1991) and Cerbin (1988) stated that a pure traditional lecture-based teaching strategy creates learners that lack the ability to develop arguments with adequate evidence. While conclusions from this study cannot refute or support Baron's and Cerbin's claims, this study can provide evidence that inquiry-based instruction is more effective than the subject matter approach in the development of argumentation skills. The findings of this study indicated that inquiry-based instruction increases the students' ability to link evidence with claims. Inquiry-based instruction may lead to learners being able to be prepared for post-secondary education or workplace careers (Kuhn 1992).

This study supports that inquiry-based instruction is more supportive of the students' ability to satisfy the needs of individuals entering careers in agriculture, attending major universities, or pursuing other postsecondary education endeavors. The NRC (1996) reported employees in a highly competitive market must have the ability to reason and provide developed arguments for or against the conclusions they reached as they are solving problems; inquiry-based instruction can help strengthen those arguments.

Driver, Newton, and Osborne (2000) stated argumentation ability is central to foundational practices of science. Inquiry-based instruction may lead to better qualified scientists and an enhanced public understanding of science. Development of students with better argumentation skills will help supply agriculturists to formulate better arguments that are supported by fact and yet enable agriculturists to understand and assess counter claims to differing solutions to a problem.

Recommendations

This study provides evidence of the effectiveness of inquiry-based instruction for school based agriscience education across the United States. Teacher educators will find the study useful in the selection of teaching methods. The results of this study could assist agricultural educators by identifying the key components to adapting curricula to inquiry-based instruction and the role that quality professional development has on student argumentation in agriscience. Based on the findings of this study, the following recommendations were made for teacher educators and curriculum developers in secondary school education:

1. Based on the finding that inquiry-based instruction is an effective method to deliver agriscience at the secondary school level, teacher educators should model inquiry-based instruction.
2. Teacher educators should provide in-service education opportunities for current teachers on inquiry-based instruction and student argumentation development.
3. Inquiry-based curricula and lesson plans that utilize this form of instruction should be developed to further the use of this teaching method.
4. Teacher educators should provide direct instruction for the development of higher scientific reasoning and argumentation skills in their preservice program and provide professional development for in-service teachers.

Based on the finding of this study, the following recommendations were made for practitioners in secondary school agriscience education:

1. Strong consideration should be given to attend the NATAA professional development workshops and learn inquiry-based instruction.
2. Agriscience courses should include direct instruction on argumentation skills. This instruction should include a focus on the development of the argumentation instrument in combination of agricultural contextual problems that students support with research data they collect or review from basic agriculture and science journals.

While this study provides conclusions regarding its objectives and hypotheses, the study also developed recommendations for further research, including:

1. More experimental studies are needed in agricultural education investigating the best methods to teach agriscience education. Replication of this study involving a different group of teachers and different content focus will add to the body of knowledge for the profession.
2. A model for inquiry-based instruction integration is worthy of development due to the identified effectiveness of this teaching method.
3. Replication of this study comparing inquiry-based instruction with other teaching methods may provide insight into how to best teach agriscience.
4. This study examined the effect of the teaching methods on argumentation skills following instruction. This study should be replicated to investigate the effects of these treatments on long-term retention of content knowledge achievement, argumentation skills, and scientific reasoning.
5. This study did not assess student attitude toward the methods of instruction or the change in attitude toward science when learning under inquiry-based instruction. Further research should be conducted to determine how these teaching methods affect student attitude, motivation, and self-efficacy.

References

- Anderson, R. D. (2002). Reforming science teaching: What research says about inquiry. *Journal of Science Teacher Education*, 13(1), 1-12. doi:10.1023/A:1015171124982
- Baron, J. (1991). Beliefs about thinking. In J. F. Voss, D. N. Perkins & J. W. Segal (Eds.), *Informal reasoning and education* (pp. 169-186). Hillsdale, NJ: Lawrence Erlbaum Associates.
- Bodzin, A. & Beerer, K. (2003). Promoting inquiry-based science instruction: The validation of the Science Teacher Inquiry Rubric (STIR). *Journal of Elementary Science Education*, 15(2), 39-49. doi:10.1007/BF03173842
- Bodzin, A., & Cates, W. (2002). Inquiry dot Com. Web-based activities promote scientific inquiry learning. *The Science Teacher*, 69(9), 48-52.
- Boone, H. N., Jr. (1988). *Effects of approach to teaching on student achievement, retention, and attitude*. Unpublished dissertation, The Ohio State University, Columbus.
- Bransford, J. D., Brown, A. L., & Cocking, R. R. (2000). *How people learn: Brain, mind, experience, and school*. (2nd Ed.). Washington, D.C.: National Academy Press.

- Campbell, D. T., & Stanley, J. C. (1963). *Experimental and quasi-experimental designs for research*. Boston: Houghton Mifflin.
- Center for Agricultural and Environmental Research and Training (CAERT), (2008). <http://www.caert.net/estore1/sample.asp>
- Cerbin, B. (1988). *The nature and development of informal reasoning skills in college students*. Paper presented at the National Institute on Issues in Teaching and Learning, Chicago, IL. (ERIC Document Reproduction Service No. ED298805)
- Chiasson, T. C., & Burnett M. F. (2001). The influence of enrollment in agriscience courses on the science achievement of high school students. *Journal of Agricultural Education*, 42(1), 61-71. doi:10.5032/jae.2001.01061
- Claxton, G. (1991). *Educating the enquiring mind: The challenge for school science*. Harvester, UK: Wheatsheaf.
- Cooper, J., & Prescott, S. (1989, March). *Cooperative learning: Kids helping kids, teachers helping teachers*. Materials packet for higher education component of AACTE symposium. (ERIC Document Reproduction Service No. ED310 067)
- Davis, J. A. (1971). *Elementary survey analysis*. Englewood, NJ: Prentice-Hall.
- Driver, R., Newton, P., & Osborne, J. (2000). Establishing the norms of scientific argumentation in classrooms. *Science Education*, 84(3), 287-312. doi:10.1002/(SICI)1098-237X(200005)
- Dyer, J. E. (1995). *Effects of teaching approach on achievement, retention, and problem solving ability of Illinois agricultural education students with varying learning styles*. Unpublished doctoral dissertation, University of Illinois at Urbana-Champaign.
- Flowers, J. L. (1986). *Effects of problem solving approach on achievement, retention, and attitudes of vocational agriculture students in Illinois*. Unpublished doctoral dissertation, University of Illinois at Urbana-Champaign.
- Gall, M. D., Borg, W. R., & Gall, J. P. (1996). *Educational research: An introduction*. White Plains, NY: Longman.
- Geddis, A. (1991). Improving the quality of classroom discourse on controversial issues. *Science Education*, 75, 169-183. doi:10.1002/sec.3730750203
- Hamlin, C. (1992). Reflexivity in technology studies: Toward a technology of technology (And Science)? *Social Studies of Science*, 22(3), 511-544. doi:10.1177/0306312792022003004

- Jimenez-Aleixandre, M. P., Bullgallo-Rodriguez, A., & Duschl, R. A. (1997, March). Argument in high school genetics. *Paper presented at the National Association for Research in Science Teaching*, Chicago, IL.
- Jurs, S. G., & Glass, G. V. (1971). Experimental mortality. *Journal of Experimental Education*, 40, 62–66.
- Keil, C., Haney, J., & Zoffel, J. (2009). Improvements in student achievement and science process skills using environmental health science problem-based learning curricula. *Electronic Journal of Science Education*, 13(1), 1-18. Retrieved from <http://ejse.southwestern.edu>
- Kuhn, D. (1992). Thinking as argument. *Harvard Educational Review*, 62(2), 155-178.
- Kuhn, D. (1993). Science as argument: Implications for teaching and learning scientific thinking. *Science Education*, 77(3), 319-337. doi:10.1002/sce.3730770306
- Lampert, M. (1992). Practices and problems in teaching authentic mathematics in school. In F. Oser, A. Dick, & J.-L. Patry (Eds.), *Disseminating new knowledge about mathematics instruction*. Hillsdale, NJ: Erlbaum.
- Latour, B. W., & Woolgar, S. (1986). An anthropologist visits the laboratory. In B. Latour & S. Woolgar (Eds.), *Laboratory life: The construction of scientific facts*. (pp. 83-90). Princeton, NJ: Princeton University Press.
- Myers, B. E. (2004). *Effects of investigative laboratory integration on student content knowledge and science process skill achievement across learning styles*. Unpublished doctoral dissertation, University of Florida, Gainesville.
- Myers, B. E., & Dyer, J. E. (2006). The influence of student learning style on critical thinking skill. *Journal of Agricultural Education*, 47(1), 43-52. doi:10.5032/jae.2006.01043
- National Research Council. (1996). *National science education standards*. Washington, D.C.: National Academy Press.
- National Research Council. (2000). *Inquiry and the National Science Education Standards: A guide for teaching and learning*. Washington, D.C.: National Academy Press.
- Newcomb, L. H., McCracken, J. D., & Warmbord J. R. (1993). *Methods of teaching agriculture*. (2nd ed.). Upper Saddle River, NJ: Prentice Hall.
- Norris, S. P., & Phillips, L. M. (1994). Interpreting pragmatic meaning when reading popular reports of science. *Journal of Research in Science Teaching*, 31(9), 947-967. doi:10.1002/tea.3660310909

- Perkins, D. N., Farady, M., & Bushey, B. (1991). Everyday reasoning and the roots of intelligence. In J.F. Voss, D.N. Perkins & J.W. Segal (Eds.), *Informal reasoning and education* (pp. 83-106). Hillsdale, NJ: Lawrence Erlbaum Associates.
- Phipps, L. J., Osborne, E. W., Dyer, J. A., & Ball A. L. (2008). *Handbook on agricultural education in public schools*. (7th ed.). Clifton Park, NY: Thomson Delmar.
- Piaget, J. (1972). *The psychology of the child*. New York: Basic Books.
- Rogers, E. M. (1948). Science in general education. In E. J. McGrath (Ed.), *Science in general education*. Dubuque, IA: William C. Brown Co.
- Schen, M. S. (2007). *Scientific reasoning skills development in the introductory biology courses for undergraduates*. Unpublished doctoral dissertation, The Ohio State University, Columbus.
- Schunk, D. H. (2004). *Learning theories: An educational perspective*. (4th ed.). Upper Saddle River, NJ: Prentice Hall.
- Schwab, J. J. (1962). *The teaching of science as enquiry*. Cambridge, MA: Harvard University Press.
- Stone, C. A., & Lane, S. (2003). Consequences of a state accountability program: Examining relationships between school performance grains and teacher, student, and school variables. *Applied Measurement in Education*, 16(1), 1-26.
- Thoron, A. C., & Myers, B. E. (2009b). The effect of using vee maps verses standard laboratory reports on achieving content knowledge. *Proceedings of the 2009 Agricultural Education AAEE Research Conference, Louisville, KY*. 674-684.
- Toplak, M. E., & Stanovich, K. E. (2003). Associations between my side bias on an informal reasoning task and amount of post-secondary education. *Applied Cognitive Psychology*, 17, 851-860. doi:10.1002/acp.915
- Vygotsky, L. S. (1978). *Mind in society: The development of higher psychological processes*. Cambridge, MA: Harvard University Press.
- Zohar, A., & Nemet, F. (2002). Fostering students' knowledge and argumentation skills through dilemmas in human genetics. *Journal of Research in Science Teaching*, 39(1), 35-62. doi:10.1002/tea.10008

Does Cognitive Diversity in Groups Really Enhance Application?

Alexa J. Lamm

University of Florida
310 Rolfs Hall
PO Box 110540
Gainesville, FL 32611-0540
Ph: 352-392-0502 ext. 238
FAX: 352-392-9585
alamm@ufl.edu

Katherine Shoulders

University of Florida

T. Grady Roberts

University of Florida

Tracy Irani

University of Florida

Lori Unruh-Snyder

Purdue University

Joel Brendemuhl

University of Florida

Abstract

Collaborative group problem solving allows students to wrestle with different interpretations and solutions brought forth by group members, enhancing both critical thinking and problem solving skills. Since problem solving in groups is a common practice in agricultural education, instructors are often put in the position of organizing student groups and facilitating group learning. Research has shown that the factors according to which teachers arrange groups hold great influence over the success experienced by a group. The purpose of this study was to examine how arranging groups by problem solving style influenced group problem solving processes. Groups made up of members with heterogeneous or homogenous problem solving styles were given a problem to solve as a class project. Focus groups were conducted with each group at the conclusion of the project to gain an understanding of how each group progressed through the problem solving process. Differences were found in how homogenous versus heterogeneous groups progressed through the problem solving process. With a greater understanding of how problem solving style influences group dynamics, agricultural educators can be more proactive when assigning student work groups, thereby enhancing students' abilities to work interdependently when creating successful solutions.

Introduction

Arranging situations for problem solving is a current best practice in agricultural education because of its numerous proven benefits (Boone, 1990; Cano & Martinez, 1991; Friedel, Irani, Rhoades, Fuhrman, & Gallo, 2008; Phipps, Osborne, Dyer, & Ball, 2008). Due to the structural components of today's workplace, skills associated with problem solving are highly sought, especially when related to working in groups (Gokhale, 1995). The world of education, including primary, secondary, and post-secondary settings (Heller, Keith, & Anderson, 1992), has adopted group problem solving as a teaching technique that not only prepares students for the workforce, but also reaps cognitive benefits as well (Gokhale, 1995; Phipps et al., 2008).

Collaborative group problem solving allows students to wrestle with different interpretations and solutions brought forth by group members, thereby enhancing critical thinking and problem solving skills (Bruner, 1985; Heller et al., 1992; Vygotsky, 1978). The level of success these groups experience is largely dependent on the level of functionality of the group which is partially determined by the group makeup (Heller & Hollabaugh, 1992). Well-formed collaborative groups allow students to "share their conceptual and procedural knowledge in the joint construction of a problem solution, so that all students are actively engaged in the problem-solving process and differences of opinion are resolved in a reasonable manner" (Heller & Hollabaugh, 1992, p. 637). However, little research has been conducted on the effects of the formation of groups according to different factors, including learning styles or problem-solving style (Gokhale, 1995; Kirton, 2003). While diversity in knowledge and experiences contributes to group learning (Gokhale, 1995), the problem solving styles of individuals in a group can greatly affect the group's ability to collectively solve problems (Kirton, 2003).

As facilitators of learning in group problem solving approaches, agricultural educators are expected to organize student groups into units that will work interdependently and interact in order to arrive at solutions (McClain & Horner, 1988; Phipps et al., 2008). However, group performance based on purposeful group makeup according to problem solving style has not been studied. Assessing the effectiveness of educational programs in agricultural and life sciences and improving the success of students enrolled in agricultural and life sciences academic and technical programs is part of the National Research Agenda: Agricultural Education and Communication, 2007-2010 (Osborne, 2007). Therefore, a study exploring the effect individual problem-solving style has on the group problem solving process can provide future direction for enhancing agricultural education programs and guiding future practice.

Theoretical Framework

The theoretical framework for this study is based on both Bransford's (1984) IDEAL problem solving framework and Kirton's (2003) Adaption Innovation Theory (A-I Theory).

IDEAL Problem Solving Framework

The IDEAL problem solving framework incorporates the problem solving theories of Newell & Simon (1972), Polya (1957), and Sternberg (1981). Since its creation, the framework has been utilized in both academic and corporate settings (Kirkley, 2003). The five steps included in Bransford's (1984) model correspond to Dewey's problem solving approach, commonly utilized

in agricultural education (Phipps et al., 2008). Dewey’s approach included six steps: experiencing a provocative situation, defining the problem, seeking data and information, formulating possible solutions, and evaluating the results. Bransford’s IDEAL model follows the same sequence as Dewey’s problem solving approach, with the exclusion of Dewey’s initial step. Bransford’s model assumes the problem solver has already experienced the situation. Figure 1 displays the five steps Bransford identifies as crucial to successful problem solving, as well as the relationships between these steps.

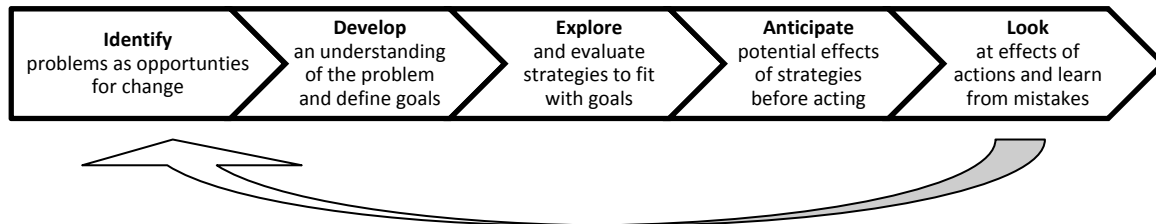

Figure 1. Bransford’s (1984) IDEAL problem solving model

As Figure 1 depicts, the five steps of the IDEAL problem solving model are fluid. They do not occur completely independently of one another, and the boundaries between them can appear “fuzzy” in observation (Bransford, 1984). Individuals first identify problems that may be present among the “stated” problem. These are problems that can be seen as “inconveniences” or “unpleasant situations”, to be tolerated as “facts of life” (Bransford, 1984, p. 12). However, identification of these underlying problems as opportunities for change allows individuals to solve problems in more creative and often more efficient manners. The next step is to develop a deep understanding of the problem(s), and based on those understandings, define goals that could lead to the problem’s solution. While problems may be identified through the first step, the second step focuses on understanding what causes these problems and identifying goals that dissolve the causes (Bransford, 1984). The third step in the framework is to explore alternative approaches to solving the problem and evaluate their relevance to the previously developed goals. Once solutions are developed, the fourth step is to anticipate the potential effects of these solutions before they are acted upon. Finally, once solutions are applied, problem solvers should look at the effects of their efforts and learn from their successes and failures. This final reflection allows for further problem solving, if necessary, as shown by the arrow at the bottom of Figure 1.

Adaption-Innovation Theory

Kirton’s (2003) Adaption-Innovation Theory (A-I Theory) examines problem solving on the individual level. Individual problem solving ability is influenced by potential capacity and learned levels of problem solving (Kirton, 1976), however, A-I Theory is strictly concerned with the influence of cognitive style - measuring how individuals prefer to solve problems (Kirton, 2003). According to A-I Theory, cognitive style is “the preferred way in which people responds to and seek to bring about change” (Kirton, 2003, p. 43) resulting in creative problem solving and decision making differences between individuals. Cognitive style variations present in the management of problem solving situations are critical to an individual’s problem-solving success and are easily identified through problem-solving situations (Kirton, 2003).

According to A-I theory, individuals' cognitive styles fall on a continuum between adaption and innovation. The scale of adaption-innovation is a continuous range, indicating that individuals' cognitive style can be anywhere between the two; therefore no individual is strictly an adaptor or strictly an innovator. However, individuals with an adaptive tendency prefer more structure when solving problems while those that are more innovative appreciate less structure when working through the problem solving process (Kirton, 2003). When solving problems, individuals exhibiting an adaptive tendency suggest more technically-efficient solutions and seek to develop "better" solutions. Individuals exhibiting an innovative tendency are more novel and seek to develop "different" solutions. Innovative individuals are more likely to require realignment of objectives, plans, or strategies (Foxall, 1986; Kirton, 1999). To innovators, adaptors appear to be safe, conforming, predictable, inflexible, and intolerant of ambiguity (Kirton, 1999, 2003). To adaptors, innovators appear to be exciting, unsound, impractical, risky, abrasive, and threatening to the established system (Kirton, 1999, 2003).

When examining the qualities of adaptors and innovators, including how individuals of each preference view one another, the implications for group work are two-sided. Homogeneous groups, consisting of all adaptors or all innovators, tend to collaborate easily and typically experience success in narrow projects (Kirton, 2003). However, success in broader projects, including several problematic facets, comes with more difficulty to homogeneous groups (Kirton, 2003). When too little structure (increased innovativeness) is present, groups will become inefficient. However, when too much structure (increased adaptive tendency) is offered by group members efficiency boomerangs and the members find themselves trapped in an "inappropriate paradigm or one in dire need of reform" (Kirton, 2003, p. 24).

Alternatively, heterogeneous groups, made up of a mix of adaptors and innovators, can experience communication difficulties due to differences in cognitive style when faced with small projects (Kirton, 2003). In these situations, heterogeneous groups are less effective than homogenous groups (Kirton, 2003). However, homogenous groups are more efficient when presented with a broad range of problems. Individuals exhibiting cognitive differences approach the aspects of problem solving with unique perspectives, offering a variety of resources a homogenous group would not have available (Kirton, 2003). As long as the group members manage their diversity well, homogenous groups are expected to be more successful at large scale problem solving than heterogeneous groups (Gokhale, 1995; Kirton, 2003).

Purpose & Research Question

The purpose of this study was to examine how grouping by problem solving style influenced the problem solving process. This purpose guided the following research question: How do homogeneous and heterogeneous problem solving style groups utilize the problem solving approach?

Methods

This study utilized the qualitative research method of focus groups to address the research question. "Focus groups are carefully planned group meetings designed to collect perceptions and information on a defined area of interest" (Chalofsky, 1999, p. 1). Unlike group interviews,

the facilitator of a focus group encourages interaction among the participants to create an opportunity to share ideas and comment on one another's perspectives (Chalofsky, 1999). While originally designed to collect marketing data, focus groups have more recently been used for program evaluation, program planning, and needs assessment (Krueger & Casey, 2000).

The unit of analysis for this study was focus groups conducted with students who participated in a study abroad course in Costa Rica regarding their perspectives on problem solving in a group setting. The course itself included three weeks of educational sessions combining lectures and field work on agricultural topics including entrepreneurship and sustainability. A problem solving entrepreneurship project was included as part of the course. For the project, each group was asked to create a natural chocolate product from scratch. The project included processing the cocoa beans, making the chocolate, selecting additional ingredients (i.e. flavoring, cookies, nuts, etc.), creating a marketing scheme for their product, marketing the product to a Latin American audience who spoke Spanish as their primary language, and assessing their product's success. Each team was required to have a PowerPoint as part of their marketing scheme and needed to create an instrument to evaluate their success/failure. Minimal guidance during the project was given by the instructors. Instruction included an introduction to chocolate making and basic questions that could be used on their evaluation instruments. Teams were also asked to present the results of their process to the entire class at the conclusion of the problem solving project.

For the entrepreneurship project, the students were broken into teams based on predetermined problem solving style. Kirton's Adaption-Innovation Inventory (KAI; Kirton, 1976) was used to assess problem solving style three weeks prior to the beginning of the course. The KAI instrument was made up of 32-items. To score the KAI, responses are totaled to create an overall participant score that can range between 32 and 160 (Kirton, 2003). Individuals scoring below 95 points are considered adaptors and those scoring 95 or above are considered innovators. Multiple research studies have established a high level of reliability and validity for the KAI (Kirton, 2003). Numerous researchers have also reported high levels of reliability for the KAI with Cronbach's alpha coefficients ranging from .80 to .90 (Taylor, 1989).

The students' overall scores ranged from 70 to 120. Six students scored below a 95, classifying them as adaptors, and five students scored a 95 or above, classifying them as innovators. Problem solving style (Kirton, 1999) was then used to divide the students into groups by arranging them by KAI scores (from high to low). This created two homogenous groups (one with three adaptors and the other with four innovators) and a heterogeneous group with three adaptors and one innovator. The students completed the entrepreneurship problem solving project within these predetermined groups.

Data Collection

Three focus groups were conducted (one with the homogenous adaptor group, one with the homogenous innovator group, and one with the heterogeneous group). Each focus group lasted approximately one hour. All respondents were coded with a pre-assigned letter designating their group (A = adaptor group; I = innovator group; X – heterogeneous group) and number based on the order that they first spoke for confidentiality. One facilitator conducted all three focus groups. Prior to starting each session, the facilitator assured the students the information shared

would not be associated with them individually. The facilitator allowed the conversation to flow naturally with minimal input. Effort was exerted to gain input from all students by providing multiple opportunities for contribution. The focus groups were audio recorded. Notes were taken at the conclusion of each session regarding the facilitator's observation of student reactions to one another's comments. The audio recordings were transcribed in detail and compared with the recordings for verification and elaboration.

Data Analysis

Once the focus groups were conducted and transcribed, content analysis was used to examine the statements expressed during the focus groups. Content analysis is a process that is "carried out on the basis of explicitly formulated rules and procedures" (Holsti, 1969, p. 3). Content analysis divides data into categories *a priori* and should permit generalization to a theoretical model (Lincoln & Guba, 1985; Neundorf, 2002;). In this case, the IDEAL problem solving model was used to establish the categories prior to analysis (Bransford, 1984).

Two coders were used for the content analysis to lower the amount of observer bias (Lincoln & Guba, 1985). One of the coders did not have any contact with the course planners or the participants themselves. This coder was not familiar with the course content, did not have interaction with participants, and was not informed of the participants' exposure to problem solving prior to data analysis. The second coder was a part of the course planning team, had contact with the participants at the conclusion of the course, and was familiar with the instructional techniques applied throughout the course.

Prior to reviewing the focus group transcriptions, the coders reviewed generalities about the different stages of problem solving together to gain consensus on the identified themes (Lincoln & Guba, 1985). Patterns, themes, and relationships within the data were then identified. At the conclusion of reviewing each groups' discussion of their problem solving process, the coders discussed the group's progression through each of the five problem solving stages. The two coders performed peer reviews by discussing their personal perceptions and generalizations. Together they came to consensus on consistent patterns, themes, and relationships. After reviewing each focus group, the coders used the commonalities and disparities in the patterns, themes, and relationships to create a visual representation of each group's process through the problem solving process. An audit trail was kept throughout the process to ensure trustworthiness (Lincoln & Guba, 1985). Researchers also ensured credibility through triangulation, referential adequacy materials, and peer debriefing (Lincoln & Guba, 1985). Observations, interviews with the course instructors, and student journal entries regarding the problem solving project provided different sources and methods to triangulate the data.

In order to determine transferability of the data resulting from this study, background information on the participants is essential (Lincoln & Guba, 1985). The participants were college-age adult learners participating in the Promoting Sustainability: Training Agricultural Practitioners in the Humid Tropics course at ["university"] the summer of 2010 in Costa Rica. Demographic data was collected online to describe the population following procedures outlined by Dillman, Smyth, and Christian (2008). The 15 participants recruited to take part in this project represented the University of Florida, Purdue University, and California State University in

Pomona. Five of the participants were female and six were male, ranging in age from 20 to 28 years of age. All eleven participants were undergraduates, with two freshman, five sophomores, five juniors, and three seniors. Nine of the participants were White, one was Hispanic, and one was Black. The participants represented diverse educational majors including agricultural business ($n=4$), animal sciences ($n=2$), economics ($n=4$), environmental horticulture ($n=1$), and chemistry ($n=1$).

Results

Each of the three groups were asked to describe how their group solved the entrepreneurship project problem, how their group worked together while solving the problem given them, and the strengths and weaknesses they personally exhibited during this process as well as those exhibited by their teammates. Their responses were then compared with the IDEAL problem solving model described by Bransford (1984).

Homogenous Innovator Group

The homogenous innovator group exhibited engagement in all five stages of the IDEAL model. However, there were disparities between the innovator group's problem solving process and the IDEAL model in relation to the timing associated with each stage and the strength of application within each stage. Their problem solving process is exhibited visually in Figure 2.

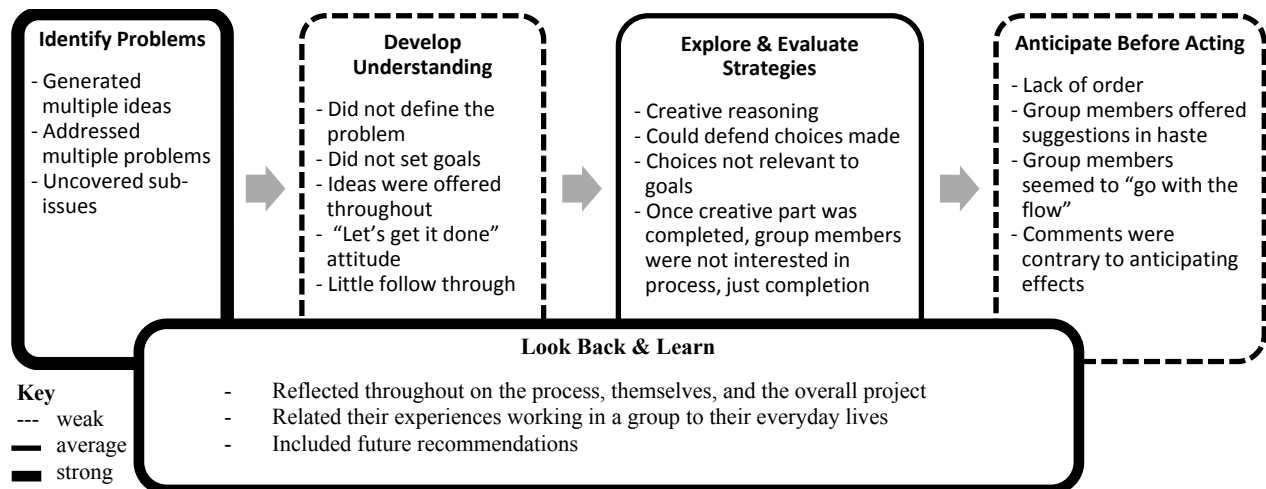

Figure 2. Homogenous innovator group problem solving process

The innovator group did not struggle with identifying problems and placed a large amount of emphasis on this step of the problem solving model. They referred to brainstorming (PI1, PI2), discussions surrounding multiple alternate solutions (PI3, PI4), and reported an ease in coming up with creative solutions to the large issue and smaller sub-issues (PI4). They felt "pretty much everyone was just saying ideas" (PI1) and that they "were really good at just kind of like coming up with ideas and then picking one" (PI2). This process was easy for them as they "didn't really have too many stumpers where [they] had to sit down and come up with solutions" (PI4).

While this group offered ideas throughout the problem solving process, they did struggle when developing an understanding of the problem. In fact, they discussed not engaging in defining the problem or setting goals. One group member (PI3) clearly articulated this when he said “We never really sat down like as you should do in a marketing study to think about your target audience, your audience, your product, and then you create a marketing plan...” Instead of a clear vision, this group exhibited a “let’s get it done” attitude, aiming for completion rather than perfection (PI2, PI3).

While trying to be efficient, this group had very little interest in the project once the creative portion was completed. They felt “if one thing is better than another thing then fine let’s just get on with it” (PI3) and wanted to “get it done and then we’re going to have free time” (PI2). They did however engage in exploring and evaluating their strategies for success through creative reasoning and being able to defend the decisions they made. When planning to market their product to students at the cafeteria, they thought about their table placement in regards to how they could make the most contact with their audience. Their groups chose to be at a table on the end because “when people walked by [they] didn’t want to sit in the middle. I mean you kind of get overlooked. And if there are people, they’re going to come, but people always look at the ends you know?” (PI1). They felt they “had a good spot. We were in the flow. People stopped by our chocolate first” (PI2). It should be noted that the innovator group’s comments surrounding their choices were all about making the most contacts. The number of contacts was not the goal of this part of the project but rather being able to report the audience liking their product, which was not addressed by this group.

Group members did discuss anticipating before acting; however it was in hindsight as most of their choices were made in haste. They “kind of just like after we decided to get it done we thought let’s do this right though” (PI4). During the chocolate mixing process they “would add more sugar, and then more milk powder to balance it out. It was pretty much a slow process and [we] learned not to rush” (PI2). Some comments were made by the group members in contrary to anticipating before acting including “We’re just going to get it done” (PI1) and “Oh the survey. We did that in like a second” (PI2).

The homogenous innovator group’s strongest problem solving area was their ability to look back and learn. They did this throughout the problem solving process, as reflection was a key component to their group dynamic. When discussing the project itself they made statements including “The chocolate... we could have made it even better. We could have had time to package it nicely” (PI2) and “Some things could have been tweaked like [Christy] said” (PI1). They also reflected on their group dynamic and how they fit in with the group. One group member (PI3) stated “I’m not responsible by myself. This is a team and we make team decisions and we’re not always going to come up with the same solutions...I’m going to go with it and be humble enough to accept that.” Another team member (PI1) felt “it’s a good learning experience to step back and maybe instead of being the leader to adapt to the surroundings and the situation... it’s learning to adapt to your situation.”

Their reflections even went a step further, applying what they were learning about themselves to their everyday lives. They felt “learning to adapt to your strengths in this type of situation is a

key to life” (PI1) and that they are all “go with the flow people and that’s why [they] don’t really have any issues getting along here or in our larger lives” (PI2).

Homogenous Adaptor Group

The homogenous adaptor group did not employ all five stages of the IDEAL problem solving model when confronted with the entrepreneurship project. Instead, they spent the majority of their time engaging in conversations surrounding their anticipated action. As a result, this group was the least successful at solving the problem they were presented with. Their problem solving process is exhibited visually in Figure 3.

Instead of identifying the problem they were presented with, the homogenous adaptor group focused their attention and comments on wanting more information or being told what to do. Comments from group members around wanting/needing more guidance included “We weren’t really taught how to cook the product within the chocolate” (PA1), “Tell us before hand so we can plan ahead” (PA3), and “At least we could have been warned ahead of time” (PA2). Since this group felt they were lacking information, awkwardness when making choices was apparent in their comments. When they went to the store to pick out their ingredients they wrestled with what to choose. One of the group members (PA2) stated “We just gotta find something and [what we chose] was kind of what we settled with but the thing was we didn’t really know. We didn’t really have any ideas before we went.” They even reported feeling frustrated by the lack of time offered by the instructors to make choices. One of the group members (PA1) stated “we really didn’t have enough time to really look around the store and think about it.”

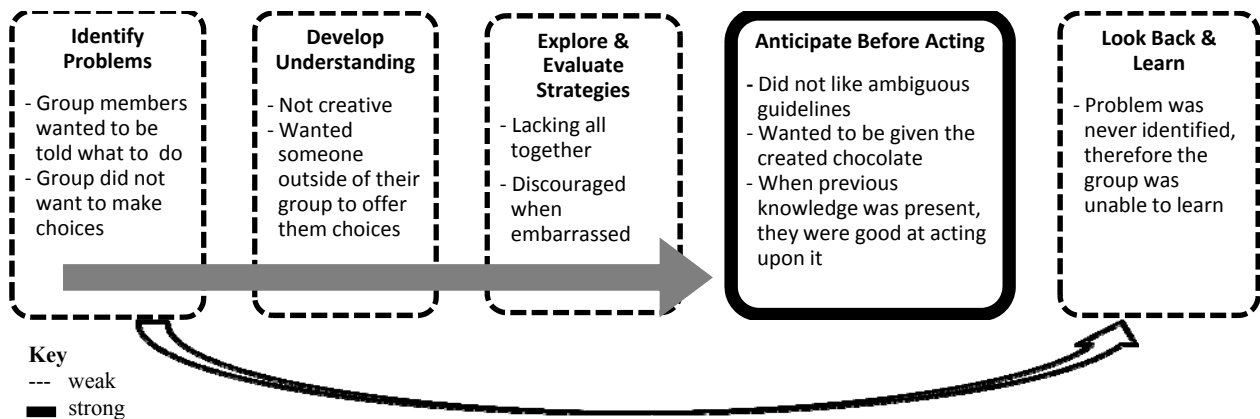

Figure 3. Homogenous adaptor group problem solving process

The adaptor group never really developed an understanding of the project. They were not creative in their choices resulting in frustration. This was reflected in statements including “We thought we were just supposed to add something to the chocolate, not necessarily to use the chocolate to put it on something like I saw some other groups” (PA1) and “Our group was under the impression that every single group was going to make chocolate and just sell like a bar of chocolate” (PA2). This lack of understanding led to frustration and embarrassment allowing for very little exploration or evaluation of their strategies. One group member (PA1) stated “I just truly didn’t understand why our group was the only group that messed up...I just didn’t

understand like what we really did wrong.” All three group members reported being embarrassed by their lack of success in the problem solving process. This emotion was portrayed by PA1 when he stated

When the entrepreneurship [instructor] laughs at it while loving everyone else’s it’s just like well I’m going to sit behind the table. I’m not going to go out and try to get people to come eat chocolate they don’t want and that we’re not proud of.

As stated earlier, the adaptor group spent the majority of their time anticipating action. They got stuck on this step of the problem solving process, and it appeared to restrict their ability to work through the rest of the process. The lack of structure offered by the instructors left them feeling lost. This team wanted to be able to plan ahead and even expressed a desire to be given the product initially rather than having to create it on their own. They felt there should have been “more of a focus on just one project cause you can learn a lot through entrepreneurship, but it take a little more time than just the time that we spent on it” (PA1). They felt the instructors told them to just “sit down and figure something out and find some ideas... we really didn’t have enough time” (PA1). PA3 stated “If we actually had like this is how you do chocolate, this is what you do with your chocolate. Tell us before hand so we can plan ahead.” PA2 also wanted more notice and stated “at least we could have been warned ahead of time.”

However, the homogenous adaptor group did express feelings of success when working on parts of the project that were dependent upon their previous knowledge. They enjoyed measuring their success, and presenting their project to the class, as they had previous knowledge of PowerPoint and Excel. “We had a great presentation/slide show because [Danielle] took a thousand pictures so we had like the best documentation of it. That was our biggest asset” (PA1). When measuring success they “plugged it all into Excel. And I mean you know made statistics” (PA2). With the data, they “decided what [they] wanted to talk about, the three main points that [they] wanted to make with the information [they] gathered” (PA1). They split up the work in this situation based on their strengths and each group member had “one specific job [they] worked on so [they] all could look at it at the end and say this looks good, you’re going to talk about it in the presentation... [they] all contributed” (PA1).

The adaptor group was never able to look back and learn from their process since a problem was never really identified initially. Instead, they discussed how they “tried to keep a good attitude and stay positive and stay happy and calm and confident as [they] could be” (PA1). They felt it “could have been a better experience for sure if [their] chocolate had actually turned out” (PA2).

Heterogeneous Group

The heterogeneous group employed all five stages of the IDEAL problem solving model simultaneously. Their problem solving process is exhibited visually in Figure 4. Reflection on how they worked together and the process itself happened throughout the entire project and was the main source of combined problem identification. They felt there “were some parts that were kind of tense but that happens in the real world so [they] think that is good that [they] experienced it on a small scale where you learn through those situations” (PX1). They also felt “any frustrations that any of [them] had were not related to working together but was more due

to disorganization and circumstance of whatever [they] were doing at the time” (PX4). They also accepted that “none of [them] had ever done it before and none of [them] were experts so none of [them] knew the right way” (PX1). While working together, they accepted one another’s differences and “sort of adjusted to that... kind of reflected the fact that it wasn’t, there wasn’t much at stake in this project” (RX3). They “really didn’t feel like it was a big deal” (RX2).

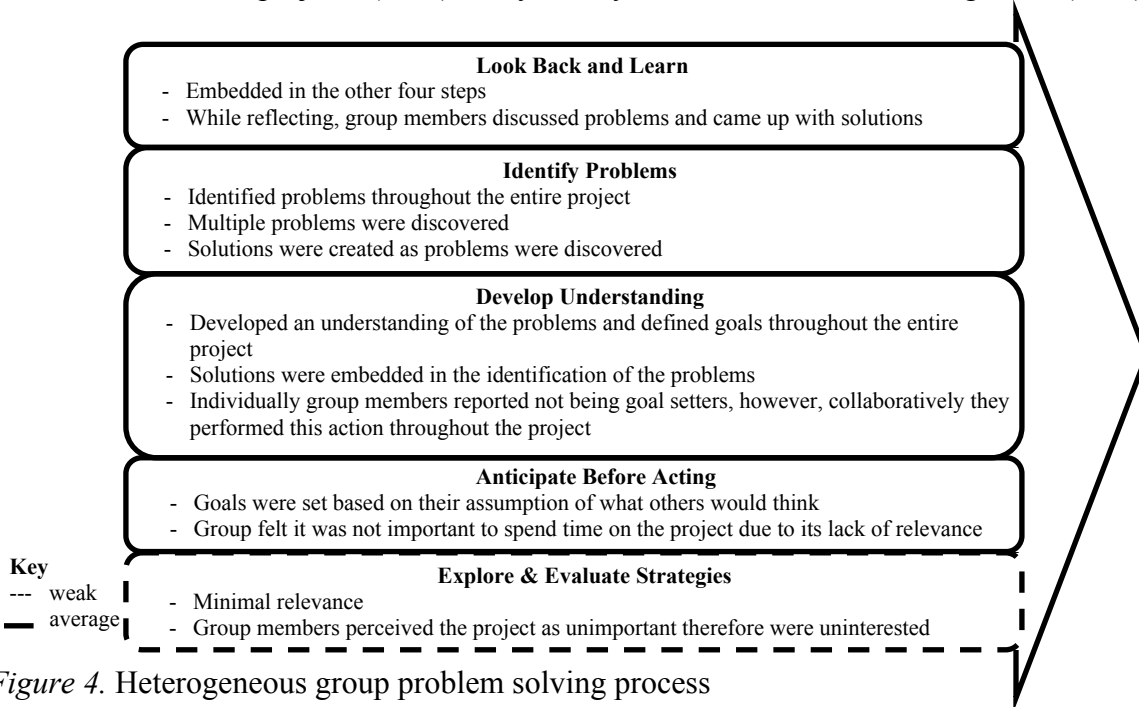

Figure 4. Heterogeneous group problem solving process

This group identified multiple problems through the project including problems working together (PX1, PX2, PX3, PX4), problems with the overall project (PX3, PX2), problems with developing a marketing plan (PX4), problems with creating tables (PX2), problems with the language barrier (PX1), and problems with the overall study abroad course (PX1, PX4). The group was able to come up with solutions and felt they “all had [their] role... and [they] were all pretty much utilized” (PX2). While the group identified problems with the project and course organization, they felt these problems

gave [them] the opportunity to enhance [their] skills and think that without the disorganization [James] is right. Like, [they] wouldn’t have seen what [they] could do. I mean, so I think sometimes things like work out in mysterious ways and that’s probably one of them (PX1).

Since the group developed an understanding of the problems and created solutions while identifying them, goals were created during the group discussions. For example, they discovered language was going to be a problem when marketing their product so they “tried to think of a theme that would like catch a general college student’s attention” (PX1) and then “worked together to translate” (PX2). Their “group was the only one that did it in Spanish” (PX4). The group members all reflected on not being team oriented in their normal lives when setting goals, however in this setting they were able to work collaboratively. PX1 stated “I’ll be the first one to admit that it’s not that I don’t care about other people’s ideas... but if it works it works and you

don't necessarily have to look for something that works a little bit better." While PX4 felt "I want to do this the best way possible the first time... versus just getting it done... I had to just let it go sometimes and be like okay it's not a big deal."

This team anticipated what others would expect of them while setting their goals. They felt it was "probably important that [their presentation] looks good" (PX1) and "liked the fact that [they] were more formal for [their] presentation versus the other groups" (PX3). One group member (PX1) stated "When I'm in a situation where I'm representing other people in my group or even just like [University] it just really bothers me that people would stand up and do something [silly]." They were also concerned with how their audience would feel about their campaign. They felt "it's kind of conceited for us to come in and say we're going to market something to you in our language because we're Americans" (PX1) and spent a lot of time translating their materials into Spanish.

Conclusions

All three groups progressed through the problem solving model differently, as exhibited visually in Figures 2, 3, and 4. The homogenous innovator group utilized all five stages of the IDEAL problem solving model (Bransford, 1984). This result is not surprising. Innovators typically prefer to solve problems with less structure (Kirton, 2003), as was provided in the presented problem. The innovative group's strengths were apparent in the identifying problems stage and the look back and learn stage which is consistent with Kirton's A-I Theory that suggests innovators seek to develop different solutions. Rather than reflecting and learning from their efforts at the conclusion of the process as Bransford's model suggests, the group shared reflective insight throughout the entire project. Their weaknesses as a group were in the developing an understanding and anticipating before acting stages, which are consistent with previous research showing innovators often need realignment of objectives and can be seen as risky, willing to jump into things before fully thinking them through (Foxall, 1986; Kirton, 1999).

The homogenous adaptor group did not utilize all five stages of the IDEAL problem solving model (Bransford, 1984). Instead, this group spent the majority of their time in the anticipating before acting stage. They strongly disliked the ambiguous guidelines offered by the professors, which is consistent with A-I Theory (Kirton, 2003) that suggests adaptors prefer structure, are less flexible, and are intolerant of ambiguity. Because the group focused so intently on anticipating before acting, they could not progress through any of the other stages of the problem solving process with any depth. As a result, this group was slower than the other groups in developing their product, never created a high quality product, and was embarrassed by their results.

The heterogeneous group utilized all five stages of the IDEAL problem solving model simultaneously (Bransford, 1984). Unlike Bransford's model, which suggests a linear approach to problem solving, this group combined the stages by reflecting throughout the process. They worked together to identify problems, created solutions as problems were identified, came up with goals while creating solutions, and thoroughly anticipated what others would think of their solutions throughout the process. Interestingly enough, the group members reported that this is not how they normally work, but that in this setting they were able to work collaboratively. The results are consistent with Kirton's (2003) A-I Theory, claiming individuals exhibiting cognitive differences bring unique perspectives and offer more resources for solving broad problems.

Implications/Recommendations

The key implication for agricultural educators working to enhance educational programs is to be aware of, and address, the impact individual problem solving style can have on group dynamics. Agricultural educators, as facilitators of group problem solving approaches, need to organize student groups into diverse units that can work interdependently and interact to create successful solutions (McClain & Horner, 1988; Phipps et al., 2008). This study shows there are benefits and drawbacks to how groups with homogenous and heterogeneous problem solving style members work together. Since skills associated with problem solving are highly sought after in the workforce, especially when related to working in groups (Gokhale, 1995), educators need to consider problem solving style when implementing strategies that focus on building student capacity in this area.

Additional research measuring the impact homogenous and heterogeneous problem solving style grouping has on student learning and engagement in a more typical classroom environment, rather than during a study abroad course, would assist in determining if the results found here are localized to this population and/or setting. In addition, research examining whether or not the complexity and ambiguity of the problem presented had an effect on the results could assist in further understanding how homogenous and heterogeneous groups differ in how they approach problem solving.

References

- Bransford, J. (1984). *The IDEAL problem solver*. New York: W. H. Freeman and Company.
- Bruner, J. (1985). Vygotsky: An historical and conceptual perspective. *Culture, communication, and cognition: Vygotskian perspectives*, 21-34. London: Cambridge University Press.
- Boone, H. N. (1990). Effect of level of problem solving approach to teaching on student achievement and retention. *Journal of Agricultural Education*, 31(1), 18 - 26. doi:10.5032/jae.1990.01018
- Cano, J., & Martinez, C. (1991). The relationship between cognitive performance and critical thinking abilities among selected agricultural education students. *Journal of Agricultural Education*, 32(1), 24-29. doi:10.5032/jae.1991.01024
- Chalofsky, N. (1999). *How to conduct focus groups*. Alexandria, VA: American Society for Training and Development.
- Dillman, D. A., Smyth, J. D., & Christian, L. M. (2008). *Internet, mail, and mixed-mode surveys: The tailored design method*. Hoboken, NJ: John Wiley & Sons, Inc.
- Foxall, G. R. (1986). Managers in transition: An empirical test of Kirton's adaption-innovation theory and its implications for the mid-career MBA. *Technovation*, 4, 129-232.
- Friedel, C. R., Irani, T. A., Rhoades, E. B., Fuhrman, N. E., & Gallo, M. (2008). It's in the genes: Exploring relationships between critical thinking and problem solving in undergraduate agriscience students' solutions to problems in mendelian genetics. *Journal of Agricultural Education*, 49(4), 25-38. doi: 10.5032/jae.2008.04025

- Gokhale, A. A. (1995). Collaborative learning enhances critical thinking. *Journal of Technology Education*, 7(1), 22-30.
- Heller, P., & Hollabaugh, M. (1992). Teaching problem solving through cooperative grouping, part 2: Designing problems and structuring groups. *American Journal of Physics*, 60(7), 637-644.
- Heller, P., Keith, R., & Anderson, S. (1992). Teaching problem solving through cooperative grouping, part 1: Group versus individual problem solving. *American Journal of Physics*, 60(7), 627-636.
- Holsti, O. R. (1969). *Content analysis for the social sciences and humanities*. Reading, MA: Addison-Wesley.
- Kirkley, J. (2003). *Principles for teaching problem solving* (Technical Paper No. 4). Bloomington, MN: Plato Learning, Inc.
- Kirton, M. J. (1976). Adaptors and innovators: A description of measure. *Journal of Applied Psychology*, 61, 622 - 629.
- Kirton, M. J. (1999). *Kirton Adaption-Innovation Inventory Feedback Booklet*. Newmarket, Suffolk, UK: Occupational Research Center.
- Kirton, M. J. (2003). *Adaption-Innovation: In the context of diversity and change*. New York, NY: Routledge.
- Krueger, R. A., & Casey, M. A. (2000). *Focus groups: A practical guide for applied research* (3rd ed.). Thousand Oaks, CA: Sage Publications, Inc.
- Lincoln, Y. S., & Guba, E. G. (1985). *Naturalistic inquiry*. Newbury Park, CA: Sage Publication, Inc.
- McClain, C., & Horner, J. (1988). Vocational agriculture teacher personality and effective teaching: Is there a relationship? *Proceedings of the Central States Annual Research Conference in Agricultural Education*. (ERIC Document Reproduction Service No. ED 290 868).**
- Neuendorf, K. (2002). *The content analysis guidebook*. Thousand Oaks, CA: Sage Publications, Inc.
- Newell, A., & Simon, H. A. (1972). *Human problem solving*. Englewood Cliffs, NJ: Prentice Hall.

- Osborne, E. W. (Ed.) (2007). *National research agenda: Agricultural education and communication, 2007-2010*. Gainesville, FL: University of Florida, Department of Agricultural Education and Communication.
- Phipps, L. J., Osborne, E. W., Dyer, J. E., & Ball, A. (2008). *Handbook on agricultural education in public schools* (6th ed.). Clifton Park, NY: Thomson Delmar Learning.
- Polya, G. (1957). *How to solve it*. Garden City, NY: Doubleday Anchor.
- Sternberg, R. J. (1981). Intelligence as thinking and learning skills. *Educational Leadership*, 39, 18-20.
- Taylor, W. G. K. (1989). The Kirton adaption-innovation inventory: A re-examination of the factor structure. *Journal of Organizational Behavior*, 10, 297-307.
- Vygotsky, L. (1978). *Mind in society: The development of higher psychological processes*. Cambridge: Harvard University Press.

A Gender Analysis of Job Satisfaction Levels of Agricultural Education Teachers in Georgia

Donald Gilman

Instructor, Worth County, Georgia High School

Jason B. Peake

Associate Professor, University of Georgia

Brian Parr

Assistant Professor, Auburn University

Abstract

The over-arching premise of many concerning issues in secondary agricultural education may be directly related to levels of job satisfaction (Delnero & Weeks, 2000). The purpose of this study was to examine the factors that influenced the perceptions of job satisfaction/dissatisfaction among agricultural educators in Georgia. Male and female agriculture teachers in Georgia are satisfied with their jobs, and they do not differ significantly in terms of their overall job satisfaction scores. These findings concur with those found by Cano and Miller's 1992 study. With respect to the job satisfier and dissatisfier factors, both male and female agriculture teachers rated "the work itself" highest among the job satisfier indicators. Males and females rated "school policy" lowest from the variables identified as job dissatisfiers; indicating that regardless of gender, agriculture teachers are most dissatisfied with school policy. The results of this study may be beneficial to state and local school agencies in determining the needs of agricultural educators to lessen the factors of job dissatisfaction and increase factors that help maintain teacher retention.

Introduction

In light of the current shortage of qualified secondary agricultural educators who are willing to enter and remain in the profession (Kantrovich, 2007) as well as the projected shortages in agricultural educators in the years to come (Walker, Garton & Kitchel 2004), it is important to understand the factors that impact job satisfaction and, possibly more crucially, those factors that influence job dissatisfaction for secondary agriculture teachers. Camp (2000) identified the agriculture teacher shortage problem as early as 1977, and the problem has continued well into its third decade (Walker, Garton, & Kitchel, 2004). As the problem of longevity and a short supply of agricultural educators continues, studies of behavioral predictions must be made so that decision makers can form sound judgments based upon indicators that accurately portray satisfaction or dissatisfaction. Walker, Garton & Kitchel (2004) stated that "we are in the worst teacher shortage ever" (p.28); in light of this statement, identifying factors that influence individuals' decisions to stay in the occupational field of education is vital to

slowing the shortage of educators through attrition. Decision makers are faced with assessing how to extend the longevity of educators' careers and determining satisfaction/dissatisfaction factors. To further compound the situation, studies have shown differences of perceptions in job satisfaction between genders that should be investigated (Scott, Swortzel & Taylor, 2005). This study grew out of the need to examine agricultural educators in Georgia to determine their level of job satisfaction, to see what factors influenced their satisfaction and dissatisfaction, and to possibly discover correlations that could guide decision makers in the development of future policy that could lead to higher levels of job satisfaction and, subsequently, increased teacher retention.

Satisfaction can be described as approval, pleasure, happiness, fulfillment, contentment, agreement, or liking. All of these terms describe feelings that are formulated about the work environment that influences one's perceptions of satisfaction or dissatisfaction within the work place (Wood, 1973). Kelly defined satisfaction as the perceived difference between accomplishments and the reward that the individual received for those accomplishments (1980). Crucial issues of teacher attraction and retention face the field of agricultural education today. The over-arching premise of many of these issues may be directly related to levels of job satisfaction (Delnero & Weeks, 2000). Previous research has shown that the field of agricultural education is no exception when it comes to the importance of job satisfaction as related to teachers' decision to enter and remain in the teaching field; the level of job satisfaction may provide a means of predicting longevity (Cano & Miller, 1992). In addition, job satisfaction has been shown to provide an insight to the level of job performance realized by an employee (Cano & Miller, 1992). Knox (1967) identified three categories of behavior necessary to achieve organizational effectiveness that dealt squarely with the concerns of job satisfaction, "First, people must join an organization and remain in it. Second, they must perform adequately in the roles to which they assigned. Third, they must occasionally engage in cooperative and innovative behavior beyond that required for membership maintenance" (Wood, 1973, p.3)

Teaching secondary agriculture is a very complex job with various facets that must be considered. According to Ricketts, Duncan, Peake, & Uessler (2005), "There is more to teaching agriculture than content and pedagogical process" (p. 47). While the duties of the job have certainly changed over time (Delnero & Weeks, 2000), the constant has been that the job of being an agricultural education instructor is both demanding and challenging. Agriculture teachers draw upon physical, emotional and intellectual resources in order to be effective in the classroom (Cano, 1990). The intense requirements of a job of this nature can lead to dissatisfaction. Furthermore, there is the contention that the strains and potential sources of dissatisfaction could be different between the two genders. To further illustrate this point, Ricketts, Stone, & Adams (2006) stated that, "significant [unique] factors have been found to contribute to the occupational success or failure of a female" (p. 54).

Several studies have been conducted in the past to measure satisfaction /dissatisfaction among professionals in agricultural education. Through these studies, researchers have discovered evidence that supports the anecdotal notion held by many. The basic premise of this area of research was stated well in the following quote from Walker, Garton, & Kitchel, "if an individual is not satisfied with his/her job, the likelihood for that individual to remain in the teaching profession is greatly diminished" (2004, p.29). Several researchers (Beavers,

Jewell, & Malpiedi, 1987; Flowers & Pebble, 1988; Grady, 1985; Newcomb, Betts, & Cano, 1987) have examined such satisfaction factors among agricultural educators.

Much research has uncovered many of the reasons why agricultural educators become dissatisfied with their positions. Further, recent evidence suggests that many people are dissatisfied with their jobs or alienated from work altogether (Wicks & Lindner 2003). Justification for the need to investigate job satisfaction is exemplified in the seemingly observed relationship between the level of job dissatisfaction and turnover, absenteeism, and tardiness (Locke, 1976). Previous research has determined that when agricultural education professionals perceive compensation strategies to be unfair, job satisfaction and performance are at risk (Wicks & Lindner 2003). What is more, Wicks and Linder determined that “research has shown that agricultural education professionals have perceived that they are not being fairly compensated” (p.115). Castillo, Conklin and Cano reported in 1999 “Teachers were least satisfied with finances related to teaching” (p.25). Furthermore, research from Walker, Garton, and Kitchel (2004) pointed out “lack of administrative support” was the most frequently reported reason given by leavers, followed closely by family issues” (p.29) as additional and relative reasons for job dissatisfaction factors.

General consensus among researchers (Bowen & Radhakrishna, 1991; Cano & Miller, 1992; Castillo, Conklin, & Cano, 1999; Walker, Garton, & Kitchel, 2004) points to secondary agricultural educators being somewhat satisfied with their jobs or at least not dissatisfied with their jobs (Bennett, Iverson, Rohs, Langone and Edwards, 2002). Castillo, Conklin and Cano, 1999, replicated studies performed earlier by Cano and Miller (1992) and reached similar conclusions. Researchers as recent as 2007 have stated that second year agricultural teachers “are satisfied with their jobs” (Aschenbrener, Terry, Torres & Smith 2007, p.56). In an additional study by Cano and Miller in 1992, based upon six taxonomies of agricultural education, it was concluded that “agriculture teachers in the six taxonomies were slightly to somewhat satisfied with each of the five job satisfier factors. However, teachers were undecided about their job satisfaction when all facets of their jobs were considered.”(p.13)

In light of the research that has indicated that other groups of agricultural educators were fairly to moderately satisfied with their jobs (Cano & Miller, 1992) and with the aforementioned research indicators available to use as a comparison, the question explored by the researchers in this study was, how satisfied or dissatisfied are educators in Georgia. Determining which factors weigh the heaviest in terms of satisfaction and dissatisfaction as well as the differences observed in these factors between genders may open areas of opportunity for teacher preparation programs as well as strengthen opportunities that are offered state wide in Agricultural Education programs.

Previous studies have been inconclusive about any definite relationship between age and job satisfaction as well as the relationship between length of service and satisfaction. Earlier findings implied that older or younger teachers were not necessarily more or less satisfied with their jobs. A further implication was that the longer a teacher remained in the teaching profession; their level of overall job satisfaction was not affected (Castillo & Cano 1999). The teacher’s age, years in current position, total years teaching, and degree status were not

significantly related to overall job satisfaction (Cano & Miller 1992) in other settings, but would these findings hold true in Georgia?

Theoretical Framework

The concept that job satisfaction is measurable is the premise of the Motivator-Hygiene Theory (Herzberg, Mausner & Snyderman, 1959). The theory states that jobs have factors which lead to satisfaction or dissatisfaction. According to Castillo & Cano,

Job satisfying (motivator) factors included achievement, recognition, work itself, responsibilities, and advancement. Job satisfying factors allowed individuals to satisfy their psychological potential and were usually related to the work itself. Job dissatisfying (hygiene) factors were related to the work environment and were pursued in order to prevent job dissatisfaction or discomfort. Job dissatisfying factors included pay, working conditions, supervision, policies, and interpersonal relationships (1999, p.67).

This study is built upon the theoretical framework outlined by Herzberg, Mausner, and Snyderman (1959) that contended that if certain aspects of an employee's perception could be understood, then working conditions could be manipulated to enhance worker satisfaction and to lessen dissatisfaction. Before organizational changes take place, the anticipated sensitive factors for employees need to be identified and analyzed. By identifying and analyzing these factors, administrators will have an understanding of what their employees want from their work. Understanding what their employees want from work can help administrators develop in-service trainings that will meet the needs of their employees, thus keeping job satisfaction at a maximum while simultaneously reducing job dissatisfaction (Scott, Swortzel, Taylor, 2005). According to Hackman & Oldham, 1980, "The key to job satisfaction in the work place is to focus on changing those areas of work that employees want changed, and not the areas that journalists or behavioral scientists think that employees should want changed" (p. 252).

It is apparent that there are many factors to consider when examining the phenomena of job satisfaction. Teacher retention in Georgia agricultural education will be a priority over the next ten years as a measure to lessen the shortage of educators. Identifying factors that impact retention, *i.e.* satisfaction/dissatisfaction will play a role in lessening the deficit of competent agricultural educators.

Purpose/Objectives

The purpose of this study was to examine the factors that influenced the perceptions of job satisfaction/dissatisfaction among agricultural educators in Georgia.

The results of this study may be beneficial to state and local school agencies in determining the needs of agricultural educators so that they may be able to lessen the factors of job dissatisfaction and increase factors that help maintain teacher retention. The results may further be beneficial to the agricultural education programs that prepare teachers for service in the educational system by exposing the values that practicing educators recognize as factors that contribute to job retention. In addition, the study may also be of assistance

to other educators in the Career, Technical and Agricultural Education programs in Georgia because of the parallelism among jobs in this particular field of education. This study serves as a data point in achieving the objectives of the National Agricultural Education Research Agenda, especially the priority area “Prepare and provide an abundance of fully qualified and highly motivated agricultural educators at all levels.”

The objectives of this study were as follows:

- 1. Describe selected demographic characteristics of secondary agriculture teachers in the state of Georgia.**
- 2. Describe relationships between secondary agriculture teachers’ level of job satisfaction and selected demographic variables.**

Methods/Procedures

The research method used for this study was a survey of the population of agricultural educators in Georgia. The population received a modified form of an instrument developed by Brayfield & Roth (1951) that was also used in the Cano & Miller (1992) study so that the results of this study could be compared directly to the earlier study to determine if there are parallel conclusions or discrepancies that warrant further investigation.

The population for this study included 380 high school, middle school and Young Farmer educators that were employed in the state of Georgia in 2007. The groups were educators in the north, central and south regions of agricultural education as described by the Georgia Department of Education and identified by gender.

Brayfield and Roth (1951) formulated the instrument used in this study that was employed to measure one’s perceptions of job satisfaction . This instrument has been used in its original form or modified in several studies over the years as a means to predict how job interaction will predict longevity of workers. Cano and Miller (1992) suggested using an instrument such as the Brayfield –Roth (1951) index to assess job satisfaction of agricultural educators.

The “Job Satisfaction Index” constituted Part I of the questionnaire. Wood’s (1973) instrument was used to assess the level of job satisfaction among secondary agricultural education teachers. Participants were asked to score that series of 21 statements on a Likert type scale with such statements as: My job is like a hobby to me; I am satisfied with my job for the time being; and I find real enjoyment in my work. Wood’s instrument constituted Part II of the questionnaire and provided the basis for describing teacher perceptions of the following factors: achievement, advancement, recognition, responsibility, the work itself, supervision, salary, interpersonal relations, policy and administration, and working conditions. Part III of the questionnaire consisted of demographic variables specific to educators in Georgia. This instrument was chosen so that replication of the Cano & Miller 1992 study could be performed.

Reliability for the Brayfield-Rothe Job Satisfaction Index that had been established previously via the Cronbach alpha procedure was .90, .94, and .90 in the Newcomb, et al. (1987), Cano and Miller (1992), and Castillo, et al. (1997) studies respectively. For this study, 225 out of 380 educators participated which provided a population to base recommendations on.

The collection of data was performed by the researchers at the two conferences of Georgia Agricultural Educators in January and July, 2007. The researcher administered the survey and scored the responses. Each participant provided demographic information including: gender, years of teaching experience, years in current position, geographical region, age, education level, etc.

All data was analyzed using the Statistical Package for the Social Sciences 14.0. Independent sample t-test, means, standard deviation, and frequencies were calculated to analyze the data. The alpha level was set *a priori* at .05 as in the Newcomb, Betts, and Cano (1987), Cano and Miller (1992), and the Castillo, Cano, and Conklin (1997) studies.

Of the 380 agricultural educators in Georgia, 225 responded to the survey (n=135 early responders; n=90 late responders) Early responders were defined as the subjects that completed the survey in January 2007 at the Georgia Vocational Agricultural Teachers' Association Mid Winter Conference. Late responders were defined as those who completed the survey at the GVATA Summer Conference in July 2007. A participation rate of 59% of the total population was achieved. Nonresponse error was controlled by comparing early responses to late responses (Lindner, Murphy & Briers, 2001). After compiling the data, it was determined that there were no statistically significant differences between early and late responders participating in the study. It was, therefore, concluded that results could be generalized to the target population, and nonresponse error was lessened as a threat to the external validity of the study.

Results

It was found that 72 percent (162) of the participants were male while 28 percent (63) were female (Table 1). It was found that the mean age for female agriculture teachers was 31.64 years while the mean age for male teachers was 40.31 years. Male teachers were significantly older than female teachers as concluded by the t-test. Male teachers, on the average, had 10.13 years of teaching experience while females averaged 4.76 years (Table 1). Males had significantly more years of teaching experience than females. Furthermore, male teachers had been in their current positions 3.35 years compared to female teachers 1.88 years in their current positions.

Table 1. Means, Standard Deviations, and t-tests for Selected Demographic Variables

Variable	Males (n=162)		Females (n=63)		t-	Prob.
	Mean	SD	Mean	SD		
Age	40.31	10.40	31.64	9.18	-5.64	.001
Total years of teaching	10.13	8.65	4.76	5.69	-4.39	.001
Years in current position	3.35	1.98	1.88	1.54	-5.20	.001

Based on a five point Likert type scale with responses ranging from strongly disagree (1- lowest level of satisfaction) to strongly agree (5- highest level of satisfaction), males provided a mean score of 2.93, while females provided a mean score of 2.94 on the overall job satisfaction scale (Table 2). The mean scores for male and female secondary agriculture teachers on the overall job satisfaction scale were not significantly different.

Table 2. Means, Standard Deviations, and t-test for Overall Job Satisfaction

Variable	Males (n=162)		Females (n=63)		t-value	Prob.
	Mean	SD	Mean	SD		
Overall job satisfaction	2.93	.21	2.94	.27	.21	.836

Note: Based on scale: 1=strongly disagree; 2=disagree; 3=undecided; 4=agree
5=strongly agree.

Utilizing a six point Likert type scale with responses ranging from very dissatisfied (1), to very satisfied (6), males provided the following mean scores on the job satisfier factors: achievement, 4.78; advancement, 4.83; recognition, 4.53; responsibility, 4.89; the work itself, 5.09 (Table 3). The same Likert type scale yielded the following mean scores for female agriculture teachers: achievement, 4.77; advancement, 4.57; recognition, 4.44; responsibility, 4.79; the work itself, 5.03; Male and female agriculture teachers did not differ significantly on any of the job satisfier factors (Table 3). Responses from male and female agriculture teachers revealed from the mean score the following: “The work itself” provided the highest mean for both male and females illustrating a high contentment with their jobs.

Using the same six point Likert type scale with responses ranging from very dissatisfied (1), to very satisfied (6), males provided the following mean scores on the job dissatisfier factors: interpersonal relationships, 5.03; policy and administration, 4.42; salary, 4.65; supervision/technical, 4.91; working conditions, 4.87 (Table 3). The same Likert type scale yielded the following mean scores for female agriculture teachers; interpersonal relationships, 5.02; policy and administration, 4.18; salary, 4.66; supervision/technical, 4.72; working conditions, 4.57. Male and female agriculture teachers did not differ significantly on any of the job dissatisfier factors (Table 3). Males tended to be slightly more satisfied with their salary than did females. Males and Females scored nearly the same response on interpersonal relationship. The evidence here would tend to suggest that while agriculture teachers may not be happy with policy and administration, they value the relationships that are formed in the school systems that they are employed in. Both groups showed slight satisfaction with the factors that were identified as factors for dissatisfaction with both groups means scores being the lowest on policy and administration.

The research supports evidence that both males and females surveyed were satisfied with the individual aspects of their jobs as described in questions 22 – 31. All respondents’ scores range from slightly satisfied to somewhat satisfied showing overall satisfaction for the described facets of their jobs. The work itself coupled with interpersonal relationships scored the highest mean scores for both groups with virtually identical scores. These two factors give important insight to key areas of job satisfaction for Georgia agriculture educators.

Table 3. Means, Standard Deviations, and t-tests for Job Satisfier and Job Dissatisfier Factors.

Variable	Males (n=162)		Females (n=63)		t-value	Prob.
	Mean	SD	Mean	SD		
Job Satisfiers						
Achievement	4.78	1.01	4.77	.97	-.09	.929
Advancement	4.83	1.00	4.57	1.10	-1.62	.106
Recognition	4.52	1.29	4.44	1.18	-.43	.664
Responsibility	4.89	1.07	4.79	1.14	-.62	.534
The Work Itself	5.09	.87	5.03	.98	-.40	.692
Job Dissatisfier						
Interpersonal Relationships	5.03	.90	5.02	.97	-.10	.920
Policy and Administration	4.42	1.39	4.18	1.53	-1.11	.271
Salary	4.65	1.15	4.66	1.14	.01	.993
Supervision/Technical	4.91	.99	4.72	.99	-1.30	.196
Working Conditions	4.87	1.05	4.57	1.29	-1.79	.075

Note: Based on scale: 1=very dissatisfied; 2=somewhat dissatisfied; 3=slightly dissatisfied; 4=slightly satisfied; 5=somewhat satisfied; 6=very satisfied.

Correlations were calculated to describe the relationships between agriculture teachers' level of job satisfaction and selected demographic variables. The coefficients ranged in magnitude from negligible to moderate according to Peake (2003). The coefficients for males were (Table 4): age, -.08; years in current position, .08; total years teaching, -.11; level of education, .01. Coefficients for females were (Table 4): age, -.20; years in current position, .07; total years teaching, -.25; level of education, -.17. The only area that showed significant difference in correlation was level of education; all other areas did not show significant differences. The coefficients illustrated that the longer a person is in their job, the more dissatisfied they are; it is more clearly seen with the female population.

Table 4. Relationship Between Overall Job Satisfaction and Selected Demographic Variables.

Variable	Males (n=162)	Females (n=63)
Age	-.08	-.20
Years in current position	.08	.07
Total years of teaching	-.11	-.25
Level of education	.01	-.17

Correlations were calculated to describe the relationships between agriculture teachers' overall level of job satisfaction and job satisfier factors. The coefficients for males were (Table 5): achievement, .11; advancement, .22; recognition, .12; responsibility, .20; and the work itself .26. The coefficients for females were (Table 5): achievement, .06; advancement, .17; recognition, .12; responsibility, .10; and the work itself, .26. None of the job satisfier factors

were significantly correlated with overall job satisfaction; however, the work itself had the highest correlation for both males and females (Table 5).

Table 5. Relationship between Overall Job Satisfaction and Job Satisfier Factors

Variable	Males (n=162)	Females (n=63)
Achievement	.11	.06
Advancement	.22	.17
Recognition	.12	.12
Responsibility	.20	.10
The work itself	.26	.26

Correlations were calculated to describe the relationships between agriculture teachers' overall level of job satisfaction and job dissatisfier factors. The coefficients for males were (Table 6): interpersonal relationships, .04; policy and administration, .26; salary, .18; supervision, .21; and work conditions, .20. The coefficients for females were (Table 6): interpersonal relationships, .05; policy and administration, .02; salary, .20; supervision, .20; and work conditions, .15. Males were most dissatisfied with policy and administration while females were most dissatisfied with salary and supervision. None of the job dissatisfier factors were significantly correlated with overall job satisfaction.

Table 6. Relationship Between overall Job Satisfaction and Job Dissatisfier Factors

Job Dissatisfier	Males (n=162)	Females (n=63)
Interpersonal relationships	.04	.05
Policy and administration	.26	.02
Salary	.18	.20
Supervision	.21	.20
Work conditions	.20	.15

Additionally, Pearson's correlation coefficients were calculated to describe the relationships between agriculture teachers' level of job satisfaction with salary satisfaction and the perception of being adequately paid for the job that they perform. The survey respondents answered positively to the questions regarding being adequately paid and to the question of being satisfied with their pay.

Correlations were calculated describe the relationships between agriculture teachers' level of job satisfaction and selected demographic variable in addition to using *Pearson's r²*, to examine the magnitude of the relationship. Davis, *et.al.*, (1971) and Peake (2003) identified correlations of .10 to .29 as low associations, .30 to .49 as moderate correlations, and .50 to .69 as substantial correlations when studying a group of less than five hundred. The coefficients for the variables identified in Table 7 were low correlations. However, when examining the *r²* factor for both males and females, the perception of being "adequately paid" accounts for four percent of job satisfaction. Additionally, males and females were similar in their perceptions on salary. For males, *r²*= 3.2 percent while for females, *r²* = 4 percent. Given that there was a correlation

between these two constructs, when examining both items together they account for 8 percent of the variance. Conversely, this means that there are other factors that accumulate for 92 percent of job satisfaction outside of these two constructs. In examining gender, both males and females had nearly identical views when examining their perception on compensation issues.

Table 7. Relationship Between overall Job Satisfaction and Compensation

Variables	Males (n=162)		Females (n=63)	
	r	r ²	r	r ²
Compensation				
Adequately paid	.20	.40	.20	.40
Salary	.18	.32	.20	.40

Conclusions and Implications

Male and female agriculture teachers in Georgia are satisfied with their jobs, and they do not differ significantly in terms of their overall job satisfaction scores. These findings concur with those found by Cano and Miller's 1992 study.

Since both genders showed overall satisfaction in the various areas explored in this research, it becomes incumbent upon individuals to seek out areas for individual improvement to achieve a level of satisfaction that will ensure personal longevity. Furthermore, individuals that identify areas of discontent should work with local Career, Technical and Agricultural Education supervisors and area teachers to set goals annually for their respective programs of work. Additionally this report will be sent to the state director of Agricultural Education as well as region coordinators and area teachers with the recommendation that more emphasis be placed on teachers setting and reviewing goals for completion annually.

Further findings from this research revealed that male agriculture teachers were significantly older, had significantly more years of teaching experience, and had been in their current position significantly longer than female teachers of agriculture. Male agricultural teachers made up 72% of the respondents while female teachers made up 28%. It is recommended that further research be conducted to uncover the reasons for these differences. Agricultural educators should attempt to ascertain whether the causes of these differences are related to the overall job satisfaction of agriculture teachers. Additionally, it is recommended that females be recruited to enter the teaching profession in the field of agricultural education to close the gender gap as described in this data.

Furthermore, as Cano and Miller (1992) discovered through their research, "The teacher's age, years in current position, total years teaching, and degree status were not significantly related to overall job satisfaction" (p.44) , so too do these findings hold true for the research conducted for this study of agricultural educators in Georgia.

The correlation coefficients calculated to describe the relationship between overall job satisfaction and job satisfier and dissatisfier factors ranged from .024 to .264, relationships ranging from low to significant in magnitude.

With respect to the job satisfier and dissatisfier factors, both male and female agriculture teachers rated “the work itself” highest among the job satisfier indicators. From this finding, program planners of agricultural education have been successful in assembling a quality program for the teachers to deliver to their students. Males and females rated “school policy” lowest from the variables identified as job dissatisfiers; indicating that regardless of gender, agriculture teachers are most dissatisfied with school policy. It is recommended that efforts be made to identify specific factors that cause educators to be dissatisfied with school policy. Furthermore, it is recommended that additional studies be conducted that show a comparison of agricultural educators to academic educators concerning dissatisfaction with school policy to see if this is a phenomenon that is unique to agricultural education.

State Supervisors, public school supervisors, and teacher educators should be aware that female agriculture teachers are least satisfied with “level of recognition” when comparing job satisfier factors; this indicator in the job satisfier variables ranked the lowest for females participating in the study. Persons with supervisory duties should review their procedures and methods of supervision to determine if the process is biased against females and ensure that they are properly recognized for their contributions to not only to classroom achievement but also to FFA activities and student achievement.

A further recommendation and/or implication from this study regards surveying teachers who have already left the profession. Did the teachers leave the profession due to job dissatisfaction, for better paying professions or for family related issues? It is not unwarranted to suggest that teachers who leave the profession are less satisfied, while those who do not leave are somewhat satisfied (Cano & Miller, 1992). A longitudinal study should be conducted after five years to determine if those who left the profession during the five year period were less satisfied at the time of this investigation. Teachers who have left the profession could be interviewed to determine what influenced them most in their decision to leave. Additionally, this study should be replicated on five year intervals and presented to state agricultural education planners to ensure that quality agricultural education is delivered by means of teachers that are satisfied with their perspective jobs and with the perceptions of their jobs.

Also, research has shown a correlation between job satisfaction and salaries. Agricultural educators in Georgia are satisfied with their salaries (87%). It stands to reason that this one finding with its high correlation could be a large reason why as a group, Georgia agricultural educators are satisfied with their jobs. When Ag teachers feel they are not being adequately compensated for their work they are dissatisfied (Wicks & Lindner, 2003). Given that Georgia Ag educators were satisfied with their compensation, the cited research gives credibility to the theory that the compensation system in Georgia attributes to teacher satisfaction to both male and female teachers alike based upon correlations from this study. Extra measures should be extended by state leadership to ensure that the current or a better pay scale stays in effect for persons engaged in Georgia’s agricultural education delivery system.

Other replications of this study in different geographical areas should be conducted. In conclusion, the following are the recommendations that have been derived from this study.

1. State supervisors and staff should administer the instrument from this study yearly as a means to identify areas for teacher improvements as a self help technique to strengthen areas needed.
2. Continued emphasis should remain in place to ensure that Georgia agricultural educators have a quality education program to deliver.
3. Persons with supervisory duties should review their procedures and methods of supervision to determine if the process is biased against females and ensure that they are properly recognized for their contributions to not only to classroom achievement but also to FFA activities and student achievement.
4. A longitudinal study should be conducted after five years to determine if teachers who left the profession during the five year period were dissatisfied and the reasons that accompanied their departure
5. Continue and support efforts that ensure Georgia Agricultural Education instructors remain leaders in compensation.
6. Efforts should be made to identify the factors that cause educators to be dissatisfied with school policy.
7. Implement program to help shape teachers perceptions of their jobs in a positive manner to help build job satisfaction and career longevity.

References

- Aschenbrener, M; Terry, R; Torres, R; & Smith A; (2007) Assessment of creativity and job satisfaction of second year agricultural education teachers. *Proceedings of the 2007AAAE Research Conference*. 55-65.
- Bems, R. G. (1989). Job satisfaction of vocational education teachers in Northwest Q&. Northwest Ohio Vocational Education Personnel Development Regional Center. Bowling Green, OH: Bowling Green State University.
- Bowen, B.E; Radhakrishna, R.B; (1991) Job satisfaction of agricultural education faculty: a constant phenomena. *Journal of Agricultural Education*. 32 (2), 16–22.
- Bennett, P.N; Iverson, M.J; Rohs, F.R; Langone, C. A. & Edwards, M.C. (2002). *Job satisfaction of agricultural teachers in Georgia and selected variables indicating their risk of leaving the teaching profession*. Paper presented at the Southern Agricultural Education Research Conference, Orlando FL.
- Brayfield, A. H., & Rothe, H. F. (1951). An index of job satisfaction. *Journal of Applied Psychology*, 35, 307-311.
- Cano, J; Miller, G. (1992a). A gender analysis of job satisfaction, job satisfier factors, and job dissatisfier factors of agricultural education teachers. *Journal of Agricultural Education*. 33 (3), 40-46.
- Cano, J; Miller, G. (1992b). An analysis of job satisfaction and job satisfier factors among six taxonomies of agricultural education teachers. *Journal of*

Agricultural Education. 33 (3), 9-16.

Castillo, J.X; Cano, J.(1999). A comparative analysis of Ohio agriculture teachers' level of job satisfaction. *Journal of Agricultural Education*. 40 (4), 68 – 79.

Castillo, J.X; Conklin, E.A; Cano, J; (1999) Job satisfaction of Ohio agricultural education teachers . *Journal of Agricultural Education*. 40 (2), 19 – 27.

Delnero, J.A; Weeks, W.G; (2000) How secondary agricultural education teachers describe their work. *Journal of Southern Agricultural Education Research*. 50 (00), 7-14.

Grady, T. L. (1985). Job satisfaction of the vocational agriculture teachers in Louisiana. *Journal of the American Association of Teacher Educators in Agriculture*, Z(3), 70-78. 85.

Hackman, J. R., & Oldham, G. R. (1976). Motivation through the design of work: Test of a theory. *Organizational Behavior and Human Performance*, 16(2), 250-279.

Hackman, J. R., & Oldham, G. R. (1980). *Work redesign*. Reading, MA: Addison-Wesley.

Herren, R.V;(1996) *The Science of Agriculture: A Biological Approach*. Albany, NY: Delmar

Herzberg, F., Mausner, B., Peterson, R. O., & Capwell, D. F. (1957). *Job attitudes: Review of research and opinion*. Pittsburgh, PA: Psychological Service of Pittsburgh.

Kantrovich, A.J. (2007) A national study of the supply and demand for teachers of agricultural education from 2004-2006. Grand Haven, MI: Michigan State University.

Kelly, E.F. (1980) Problems in the measurement of student satisfaction in ATI studies: Proposals for a new measure. Paper presented at the meeting of the American Educational Research Association, Boston.

Lindner, J.R., Murphy, T.H., Briers, G.E. (2001). The handling of nonresponse in agricultural education. 28th Annual National Agricultural Education Research Conference, December 12, 2001 p.233- 245.

Newcomb, L. H., Betts, S., & Cano, J. (1987). Extent of burnout among teachers of vocational agriculture in Ohio. *Journal of the American Association of Teacher Educators in Agriculture*. 28 (1), 26 – 34.

Peake, J.B. (2003). Relationships between student achievement and levels of computer technology integration by Texas Agriscience teachers. Unpublished doctoral dissertation. Texas A&M University: College Station

Ricketts, J.C; Duncan, D.W; Peake, J.B; Uessler, J.(2005) Teacher preparation and in service needs associated with management of the total program of agricultural education in Georgia. *Journal of Southern Agricultural Education Research*. 55 (1), 46-59.

Ricketts, J.C; Stone, R; Adams, E; (2006) Female agricultural educators in Georgia. *Journal of Southern Agricultural Education Research*. 56 (1), 52-65.

Scott, M; Swortzel, K.A; Taylor, W.N; (2005) Extension agents' perceptions of fundamental job characteristics and their level of job satisfaction. *Journal of Southern Agricultural Education Research*. 55(1), 88- 101.

Scott, M; Swortzel, K.A; Taylor, W.N;(2005) The relationships between selected demographic factors and the level of job satisfaction of extension agents. *Journal of Southern Agricultural Education Research*. 55(1), 102 - 115.

Walker, W.D; Garton, B.L; Kitchel, T.J; (2004) Job satisfaction and retention of secondary agriculture teachers. *Journal of Agricultural Education*. 45 (2), 28 – 38.

Warner, P. D.(1973). *A comparative study of three patterns of staffing within cooperative extension organization and their association with organizational structure, organizational effectiveness, job satisfaction, and role conflict*. Unpublished doctoral dissertation, Ohio State University, Columbus.

Wicks, A-M.B.; Lindner, J.R.(2003) An assessment of agricultural education faculty perceptions toward compensation levels and practices. *Journal of Southern Agricultural Education Research*. 53 (03), 113-126.

Wood, O. R. (1973). An analysis of faculty motivation to work in the North Carolina community college system. Unpublished doctoral dissertation. North Carolina State University: Raleigh.

An Examination of Trust-related Behaviors Important to Agricultural Stakeholders

*Kelsey Hall, Dr. David Doerfert, Dr. Courtney Meyers, Dr. Jon Ulmer,
Jarrott Wilkinson, Texas Tech University*

Abstract

The agricultural education profession disseminates information that facilitates decision making and may lead to behavior change by agricultural stakeholders. Individuals can also share information and deepen their knowledge about a topic through communities of practice (CoPs). The Texas Alliance for Water Conservation (TAWC) is an eight-year, producer-led project that uses on-farm demonstrations to determine the production practices that would sustain the life of the Ogallala aquifer. To facilitate information sharing among producers within the project and other shareholders, the project was structured as a CoP. Trust is necessary in the information dissemination process and for individuals to influence the behaviors of others. This study determined which trust factors were most important to agricultural stakeholders when receiving information from the TAWC project. The researchers developed an instrument with items that measured respondents' level of agreement of the importance of 38 trust-related behaviors. Fifty-five attendees at the TAWC's 2008 field day completed the questionnaire. A principal component analysis with oblique rotation indicated 11 trust-related behaviors that were important to stakeholders loaded on four factors: (1) relationship maturity, (2) individual customer focus, (3) transparent and honest, and (4) welcomes opinions. Researchers will examine these four factors to determine their influence on the CoP structure of agricultural projects. Future research seeks to administer the same instrument to other agricultural organizations.

An Examination of Trust-related Behaviors Important to Agricultural Stakeholders

Introduction

With a seemingly constant stream of emerging technologies and new ideas, the potential for change in agriculture is arguably a continuous process. Since its early beginning, the agricultural education profession has had an important role in both the basic and applied research of the related adoption processes as well as those professional roles and/or means that directly impact the decision-making processes that may lead to a behavior change by an individual or an organization.

One of the means used to establish or promote behavior change through an adoption-related process is to share new information. Rogers (2003) labeled this as diffusion which he described as a process by which an innovation, new idea, or practice is communicated through particular channels and/or educational programming over time among members of a social system. Through communication channels and educational programming, members involved with the adoption process create and disseminate information with one another in order to reach a shared understanding (Rogers).

Communities of practice (CoPs) are considered a means for individuals to “share a concern, a set of problems, or a passion about a topic, and who deepen their knowledge and expertise in an area by interacting on an ongoing basis” (Wenger, McDermott, & Snyder, 2002, p. 4). Within CoPs, individuals typically share information, valuable insight, and advice, which could help them solve problems. Members of a CoP need to trust the other members before they are willing to share their experiences, needs, aspirations and understanding of a particular problem or topic (Coakes & Clarke, 2006). The CoP will often designate a leader for the purposes of coordination and clarification, direction of communications, and to help structure the group’s interactions (Cargill, 2006)—a role Rogers (2003) would have labeled as an opinion leader or possibly a change agent. These leaders aid the CoP on the basis of their personality, expert knowledge, a wide domain of knowledge, high professional standing, and reputation, or some combination of these aspects (Tyson, 1998).

The Texas Alliance for Water Conservation (TAWC) is an eight-year, producer-led, demonstration project that includes 20 producers managing 30 field sites over more than 4,000 acres. The TAWC project conducts research to determine the practices and products that sustain profitability through more effective water management and informed decision-making processes. To this end, the project uses on-farm demonstrations of cropping and livestock systems to compare the production practices through a unique partnership of area producers, data collection technologies, and collaborating partners. The goal of the project is to extend the life of the Ogallala aquifer while maintaining the viability of local farms and communities.

To facilitate the information sharing among the producers within the TAWC project and to other external stakeholders, the project was structured as a CoP and is led by a community coordinator. In the role of community coordinator, the individual uses leadership styles such as transactional and transformational leadership to initiate change within individual farming operations and

possibly change the thinking and attitudes one might have toward agriculture and water management. It is believed by those associated with the TAWC project that its effectiveness may be partially due to the trust that local producers and other agriculture stakeholders have in the CoP's leader.

Trust is considered to be a core issue in learning and in the information dissemination process. Trust is also a requirement for teamwork and the ability of individuals to influence the behaviors of others. As CoPs are rapidly becoming an important part of agricultural education and cooperative Extension work, it's important that we understand how to make them most effective. Trust is an important aspect of this.

Conceptual Framework

Knowledge sharing is defined as “activities of transferring or disseminating knowledge from one person, group, or organization to another” (Lee, 2001, p. 324). According to Davenport and Prusak (1998), an organization's success is increasingly reliant on its ability to produce and disseminate knowledge. Research has shown that personal relationships have a strong effect on the success of knowledge transfer efforts (Hansen, 1999; Szulanski, 1996; Uzzi, 1997).

The most important characteristic of a relationship in this context is trust (Tsai & Ghoshal, 1998). Interpersonal trust, the perception that a person will not intentionally or unintentionally do anything that harms your interests, is critical to the knowledge transfer context because it enables people to share information more effortlessly and effectively (Kramer & Tyler, 1999; Mayer, Davis, & Schoorman, 1995; Sitkin, Rousseau, Burt, & Cramerer, 1998). Trust enhances cooperation, an open communication process, a committed relationship, and can be an important aspect of the effectiveness of a relationship (Dirks & Ferrin, 2002). It is believed that trust allows an organization greater flexibility, allows for information exchange, increases product and technology quality, and expands productivity and profitability (Nooteboom, 2002).

Researchers agree that trust leads to an increase in knowledge exchange (Penley & Hawkins 1985; Roberts & O'Reilly, 1974; Zand, 1972). Others such as Currall and Judge (1995) and Zaheer, McEvily, and Perrone (1998) said that trust increases the likelihood that knowledge acquired during transfer from an agricultural stakeholder is better understood and applied. Considerable evidence has been found that two-way trust leads to greater knowledge exchange such as when people trust they are more willing to give useful information (Andrews & Delahay, 2000; Penley & Hawkins, 1985; Tsai & Ghoshal, 1998; Zand, 1972) and are more willing to listen and absorb others' knowledge (Carley, 1991; Levin, 1999; Mayer et al., 1995; Srinivas, 2000).

Researchers have discussed trust as a part of an organizational culture (Cufaude, 1999; Joseph & Winston, 2004; Matinez & Dorfman, 1998). In *The Speed of Trust*, Covey (2006) described the importance of trust as the one thing that changes everything:

There is one thing that is common to every individual, relationship, team, organization, nation, economy and civilization throughout the world—one thing which, if removed will destroy the most powerful government, the most

successful business, the most thriving economy, the most influential leadership, the greatest friendship, the strongest character, the deepest love. On the other hand, if developed and leveraged, that one thing has the potential to create unparalleled success and prosperity in every dimension of life. Yet, it is the least understood, most neglected, and most underestimated possibility of our time. That one thing is trust. (p. 1)

In describing trust as a potential developmental processes that can lead to relationship trust, Covey illustrated thirteen trust-building consistent behaviors that aid organizations and individuals in building trusting personal and professional relationships (Figure 1). By effectively and appropriately applying these behaviors, Covey contends that an individual can inspire trust by others in that individual. Once accomplished, “trust brings out the best in people and literally changes the dynamics of interaction” (Covey, 2006, p. 319).

Purpose and Objective

In this time of continuous change, when our profession is called upon for our expertise and experience to initiate and facilitate the adoption of new technologies or processes, it becomes vital for us to expand our understanding of those factors that lead to success. An understanding of the trust behaviors considered important to agricultural stakeholders will allow communicators, extension personnel, and agricultural educators to tailor messages and educational programming efforts. With this purpose in mind, the single research objective of this study was to determine which trust behaviors are most important to production agricultural stakeholders when receiving information from the [project].

Method

The instrument used for this study was a researcher-designed questionnaire that was part of a larger study that examined the characteristics of trustworthy leaders and organizations including trust behaviors, personality, and information dissemination source and channel preferences. The data collected from the first section of this instrument was utilized in preparing this manuscript.

To develop the questionnaire, the researchers drew upon Stephen Covey's *Speed of Trust* (2006) as well as other studies (Mooradian, Renzl, & Matzler, 2006; Davis, Irani, & Payson, 2004; Six & Nooteboom, 2005; Carr, 2007). Covey's thirteen behaviors (Figure 1) were treated as constructs with insight to develop the resulting 38 response items being gleaned from the aforementioned sources. Participants were asked to rate their level of agreement of the importance of each item on a 6-point Likert-type scale (1 = *strongly disagree*, 6 = *strongly agree*). An “undecided” response was provided as a seventh choice and designated by the letter U at the end of the scale. Face and content validity was assessed by faculty members at [University] prior to data collection.

Trust Behavior	Description of Trust Behavior
Talk Straight	Honesty in actions. Person is being honest up-front, telling it like it is, saying what is meant, giving the facts, and making their agenda clear.
Demonstrate Respect	Based on the principles of respect, fairness, kindness, love, and civility.
Create Transparency	Defined as being open, real, genuine, and truthful so people can verify. Key principles include honesty, openness, integrity, and authenticity
Right Wrongs	Involves apologizing, making restitutions, practicing “service recoveries,” and demonstrating personal humility. People should not prevent others from discovering the truth and should not allow pride to prevent doing the right thing
Show Loyalty	Defined as giving other people credit freely, and acknowledging those that contribute without bad-mouth others behind their backs or disclosing others’ private information
Deliver Results	Involves getting the right things done and making things happen but also encompasses the idea of not making excuses for not delivering results
Get Better	Builds on being a constant learner, developing feedback systems both formal and informal and acting on feedback received.
Confront Reality	The act of taking the tough issues and facing them directly
Clarify Expectations	Create shared visions and agreements about what is to be done up front. Overall expectations are revealed, discussed, validated, and/or renegotiated.
Practice Accountability	Holding oneself accountable and holding others accountable
Listen First	Genuinely seek to understand another person’s thoughts, feelings, experiences, and point of view to find out what are important behaviors to co-workers and not assume that one knows what matters most to others
Keep Commitments	Involves discussing what will be done and then doing what was said by making commitments carefully and keeping them.
Extend Trust	Extending trust appropriately to others based on the situation, risk, and credibility of the people involved.

Figure 1: Covey (2006) described thirteen trust-building behaviors. The above list contains each of the behaviors and a brief description used to create data collection instrument.

The instrument was distributed to the attendees of the 2008 TAWC field day. The majority of the event’s schedule was spent visiting four project field sites. Industry and research leaders were also present at the event to answer questions and promote information regarding their prospective areas of expertise. After the field visits, the instrument was distributed to attendees during lunch. Fifty-five (54.45%) usable instruments were received from the 101 attendees.

The participants’ responses for the individual items within each of the thirteen constructs were totaled to create a summated score for that construct. Reliability for thirteen trust constructs was

determined using Cronbach's alpha using the data that was collected for the study. *Talk Straight* reported a 0.78 alpha. Reliability for the *Demonstrate Respect* construct had a 0.68 alpha. A 0.38 alpha was found for the *Create Transparency* construct. *Right Wrongs* construct had an alpha of 0.87. The *Show Loyalty* construct had an alpha of 0.94. *Deliver Results* construct was found to have an alpha of 0.89. A 0.94 alpha was found for the *Get Better* construct. *Confront Reality* was found to have a 0.95 alpha reliability. The *Clarify Expectations* construct had a 0.96 alpha. Both the *Practice Accountability* construct and the *Listen First* construct had an alpha of 0.96. *Keep Commitments* had only one question for the construct so statistical analysis was not needed. A 0.97 alpha was found for the *Extend Trust* construct.

Results

Demographic characteristics describe respondents in terms of their gender, ethnicity, level of education, age, and occupation. The gender of respondents was unevenly distributed with 49 males (89.10%), 3 females (5.50%), and 3 no response (5.50%). The highest reported ethnicity was white ($n = 51$, 92.70%). The only other ethnicity reported was Hispanic ($n = 1$, 1.80%). The most frequently reported level of education was a bachelor's degree ($n = 26$, 47.30%), followed by a high school diploma/GED ($n = 7$, 12.70%), an associate's degree ($n = 1$, 1.80%), a master's degree ($n = 13$, 23.60%), and a doctoral degree ($n = 4$, 7.30%). The mean age reported was 47.9, with the most frequently reported age group being 50-59 ($n = 16$, 29.00%). The lowest reported age groups were 70 years or older ($n = 2$, 3.60%) and 30-39 ($n = 7$, 12.60%), respectively. The remaining respondents fell in the groups 20-29 ($n = 8$, 14.50%), 40-49 ($n = 11$, 19.90%), and 60-69 ($n = 8$, 14.50%).

Of those attendees that responded ($n = 51$), an occupation other than listed was the most frequent response ($n = 13$, 23.60%). The next most frequent response was government leader or government agency with 21.80% ($n = 12$) and those involved in the agriculture industry with 20.00% ($n = 11$). Farmers ($n = 9$), extension agents ($n = 5$), and ranchers ($n = 1$) made up the rest of the respondents with 16.40%, 9.10%, and 1.80%, respectively. Participants indicated the number of years they have been in their profession. The mode was 6-15 years ($n = 17$) making up 30.80% of the population. The next most frequent response was 16-25 years ($n = 11$, 19.90%), while 18.20% responded with having only 0-5 years ($n = 10$) experience. Seven participants indicated they had been in the profession 26-35 years (12.60%), and only six participants (10.80%) indicated they had been in their indicated profession for 36-50 years.

To address the study objective of determining which trust factors were most important to these participants, data screening of the questionnaire was conducted using SPSS version 17.0. The data were reviewed for univariate outliers, multivariate outliers, normality, skewness, and kurtosis. In order to conduct an exploratory factor analysis, the variables needed to correlate. Researchers reviewed the correlation matrix to check for correlations greater than .3 but less than .9. The researchers utilized the Bartlett's test of sphericity to verify that the variables correlated with each other. It is desired for the Bartlett's test to have a significance value less than 0.5 to indicate some relationships between the variables. For these data, Bartlett's test, $X^2(78) = 354.69$, $p < .001$, indicated that correlations were significant and proceeding with the factor analysis was appropriate. Additionally, there were no correlations greater than .9; therefore the researchers proceeded with the belief that multicollinearity would not be a problem.

Kaiser (1974) recommended a minimum of 0.5 for the Kaiser-Meyer-Olkin (KMO) measure of sampling adequacy, and the values between 0.5 and 0.7 are mediocre, values between 0.7 and 0.8 are good, values between 0.8 and 0.9 are great, and values above 0.9 are superb. A value of 0.78 for KMO verified the sampling adequacy for the analysis and was well above the acceptable level. Researchers also examined the KMO statistic for individual variables by looking at the Anti-Image Matrices. Field (2009) suggested that values for these individual variables should be above 0.5. All of the values for individual items were above 0.7. The researchers were confident that the sample size is adequate for exploratory factor analysis.

After screening the data, a principal component analysis (PCA) with oblique rotation (promax) was conducted on the 38 statements developed to measure the trust-related behaviors. The researchers selected principal component analysis as an approach to establish which factors exist in the data and how certain variables contribute to those factors. Principal component analysis is a well-established procedure that is less complicated than factor analysis (Field, 2009). When principal component analysis is used, conclusions are not generalizable and pertain only to the sample collected. Since the researchers expected the trust-related behaviors discussed in Covey's *Speed of Trust* to be related, they chose oblique rotation, particularly promax, to allow the factors to correlate.

To select the appropriate number of factors to extract, the researcher referred to Velicer's Minimum Average Partial (MAP), Kaiser-Guttman criterion (eigenvalues > 1), and the scree plot. Velicer's MAP indicated three components according to the 1976 criterion and four components according to the revised 2000 criterion. The Kaiser-Guttman criterion identified 4 components with eigenvalues greater than 1. One of the four factors identified by Kaiser-Guttman had fewer than three variables, which indicated that this factor was not stable. The scree plot suggested three components (see Figure 2). Given the Velicer's MAP, the convergence of the scree plot, and Kaiser's criterion, four components were retained for the final analysis.

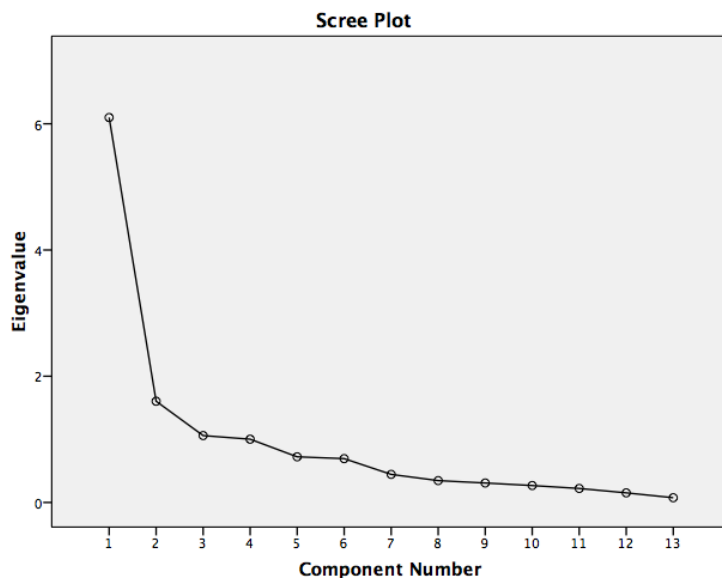

Figure 2: Scree plot of Eigenvalues for factors 1 through 13.2

Field (2009) and Stevens (2002) recommended suppressing indicator loadings less than 0.4 to assist in interpretation. This cut-off point represents loadings with important values. Only variables with loadings of .4 or higher on a factor were considered for this analysis. Once a factor structure was identified, the researchers decided which variables are important in each factor. Sample size can determine the significance of a factor loading. Stevens considered a loading greater than 0.7 to be significant for a sample size of 50. The items “Demonstrates a willingness to trust you” and “Make things happen” had factor loadings of .642 and .633, respectively. The researchers removed these two items from the solution.

The oblique rotation returned two matrices: the pattern matrix and the structure matrix. While the pattern matrix reported the regression coefficients for each variable on each factor, the structure matrix illustrated the correlation coefficients between each variable and factor. Field (2009) explained that researchers interpret the pattern matrix more frequently, but they should report both. Table 1 displays the pattern matrix. Eleven of the 38 variables were kept for the final EFA model. These four factors account for 75.12% of the variance, and were labeled relationship maturity (46.92% of the variance), individual customer focus (12.34% of the variance), transparent and honest (8.15% of the variance), and welcomes opinions (7.71% of the variance).

Factor 1 (relationship maturity) was comprised of four variables associated with how individuals address tough issues, do not break confidences, listen before speaking, and not allowing pride to interfere with doing the right thing. Factor 2 (individual customer focus) consisted of three variables based on developing formal and informal feedback systems, continuously improving, and finding out what were the most important behaviors. Factor 3 (transparent and honest) was measured by three variables that meant individuals did not over promise and under deliver, did not have hidden agendas, and did not cover things up. Factor 4 (welcomes opinions) consisted of one variable based on individuals recognizing differences in opinion.

As seen in Table 2, the structure matrix illustrated that factor 1 (relationship maturity), factor 2 (individual customer focus), and factor 3 (transparent and honest) were interrelated. The fact that correlation coefficients exist between these three factors indicated that the factors are related. If the factors were independent then the oblique rotation would have provided correlation coefficients of 0.

This exploratory factor analysis also validated the trust-related behaviors construct in the questionnaire. A value of .70 to .80 is acceptable for Cronbach’s alpha of scales (Ary, Jacobs, Razavieh, & Sorensen, 2006). The relationship maturity ($\alpha = .85$), individual customer focus ($\alpha = .88$), and transparent and honest ($\alpha = .79$) subscales of the questionnaire had high reliabilities.

Table 1

Final pattern matrix for trust-related behavior items (N = 55)

Item	Rotated Factor Loadings			
	Relationship Maturity	Individual Customer Focus	Transparent and Honest	Welcomes Opinions
Addresses the tough issues directly.	.907			
Doesn't break confidences.	.885			
Listens before they speak.	.823			
Doesn't let pride get in the way of doing the right thing.	.702			
Develop feedback systems both formal and informal.		.935		
Continuously improve.		.852		
Finds out what the most important behaviors are to you.		.814		
Doesn't over promise and under deliver.			.917	
Don't have hidden agendas.			.733	
Doesn't cover things up.			.720	
Recognizes differences in opinion.				.889
Eigenvalues	6.10	1.60	1.06	1.00
% of variance	46.92	12.34	8.15	7.71
α	.85	.88	.79	

Table 2

Final structure matrix for trust-related items (N = 55)

Item	Rotated Factor Loadings			
	Relationship Maturity	Individual Customer Focus	Transparent and Honest	Welcomes Opinions
Doesn't break confidences	.918	.458	.571	
Addresses the tough stuff/issues directly	.889		.525	
Demonstrates a willingness to trust you	.773	.454	.587	
Listens before they speak	.772	.452		
Doesn't let pride get in the way of doing the right thing	.734	.459	.419	
Develop feedback systems both formal and informal		.893		
Finds out what the most important behaviors are to you	.564	.890		
Continuously improve	.410	.849		
Make things happen	.464	.722	.548	
Doesn't Cover things up	.651		.827	
Don't have hidden agendas	.552		.824	
Doesn't over promise and under deliver			.807	
Recognizes differences in opinion				.898

Discussion

This study was an exploratory examination of the trust with an agriculture audience and is not without its limitations. One limitation of this study was the small sample size as well as the focus of the gathering as respondents were attendees at a field day focused on water management and conservation. Farmers, extension agents, and agricultural business professionals interested in agricultural topics other than water conservation may have different trust-related behaviors. Future research would need to administer the same instrument to a larger sample of members in other agricultural organizations.

Another limitation was the limited number of response items in certain constructs adapted from Stephen Covey's *Speed of Trust* that were included in the instrument. Specifically, the constructs of *Talk Straight*, *Create Transparency*, *Show Loyalty*, *Clarify Expectations*, *Practice*

Accountability, Keep Confidences, and Extended Trust each had less than three response items. Additionally, the *Demonstrate Respect* construct and the *Create Transparency* construct had low reliability with Cronbach's alphas of .68 and .38, respectively. The alpha may be lower due to the researcher-developed questionnaire, the length of the scale, or the homogeneity of the responses by the sample (Ary, et al., 2006).

Having highlighted these limitations, the results of this study present interesting implications for future research as well as for professionals engaged in diffusion-related activities with agriculture stakeholders. Effectively performing thirteen trust-building behaviors can seem overwhelming in light of other considerations such as content, logistics, and unique learner needs. If we can correctly reduce these behaviors to a more manageable number that can be effectively implemented by change agents or opinion leaders, the likelihood of success should increase.

This study revealed four factors that were important to stakeholders that attended an information dissemination and educational event (field day) commonly held in agriculture. As the TAWC project moves forward with its community of practice structure, these identified factors will be further examined to determine their influence on the viability of a CoP structure for agriculture-related projects. Israel and Wilson (2006) pointed out that participation in local networks and community activities might build stronger relationships and greater trust in local sources, leading to a great reliance. One research question that emerges is whether these results represent the "chicken" or the "egg"—or does a CoP structure engender these trust factors or are these trust factors foundational to a CoP structure with agriculture audiences.

For those involved in planning and leading such events or who work for an organization focused on facilitating the adoption of new technologies and processes important to agriculture stakeholders, the ability to integrate four behaviors—displaying relationship maturity, an individual customer focus, being transparent and honest and welcoming stakeholder opinions—could be perceived as a manageable task. If further research validates these factors as critical for success with agriculture stakeholders, then education and/or professional development activities may increase the importance of our profession's role within the future of the agriculture industry.

References

- Andrews, K.M., & Delahay, B.L. (2000). Influences on knowledge processes in organizational learning: The psychosocial filter. *Journal of Management Studies*, 37, 797-810.
- Ary, D., Jacobs, L., Razavieh, A., & Sorensen, C. (2006). *Introduction to research in education*. Belmont, CA: Wadsworth.
- Cargill, B. (2006). Leadership issues within a community of practice. In E. Coakes, & S. Clarke, *Encyclopedia of Communities of Practice in Information and Knowledge Management* (pp. 320-322). Hershey, PA: Idea Group Reference
- Carley, K. (1991). A theory of group stability. *American Sociological Review*, 56, 331-354.
- Carr, J. (2007). *An examination of rural small acreage homeowners in three west Texas counties*. Unpublished master's thesis, Texas Tech University, Lubbock.
- Coakes, E., & Clarke, S. (2006). The concept of communities of practice. In E. Coakes, & S. Clarke, (Eds.), *Encyclopedia of Communities of Practice in Information and Knowledge Management* (pp. 92-96). Hershey, PA: Idea Group Reference.
- Covey, S. (2006). *The speed of trust: The one thing that changes everything*. New York, NY: Free Press.
- Cufaude, J. (1999). Creating organizational trust. *Association Management*, 51(7), 26-35.
- Currall, S., & Judge, T. (1995). Measuring trust between organizational boundary role persons. *Organizational Behavior and Human Decision Processes*, 64, 151-170.
- Davenport, T. & Prusak, L. (1998). *Working knowledge*. Boston: Harvard Business School Press.
- Davis, K., Irani, T., & Payson, K. (2004). Going forward in education on agricultural biotechnology: Extension's role internationally. *Journal of International Agricultural and Extension Education*, 11(1), 25-34.
- Dillman, D. (2007). *Mail and internet surveys: The tailored design method* (2nd ed.). Hoboken, NJ: John Wiley & Sons, Inc.
- Dirks, K., & Ferrin, D. (2001). The role of trust in organizational settings. *Organizational Science*, 12, 450-467.
- Field, A. (2009). *Discovering statistics using SPSS* (3rd ed.). Thousand Oaks, CA: Sage Publications, Inc.
- Hansen, M. T. (1999). The search-transfer problem: The role of weak ties in sharing knowledge across organization subunits. *Administrative Science Quarterly*, 44, 82-111.
- Joseph, E., & Winston, B. (2005). A correlation of servant leadership, leader trust, and organization trust. *Leadership & Organizational Development Journal*, 26(1), 6-22.
- Kaiser, H. F. (1974). An index of factorial simplicity. *Psychometrika*, 39(1), 31-36
- Kramer, R., & Tyler, T. (Eds.). (1999). *Trust in organizations: Frontiers of theory and research*. Thousand Oaks: Sage.
- Lee, J. (2001). The impact of knowledge sharing, organization capability and partnership quality on IS outsourcing success. *Information & Management*, 38(5), 323-335.

- Levin, S. L. (1999). *Development of an instrument to measure organizational trust*. Unpublished doctoral dissertation, The George Washington University.
- Martinez, S., & Dorfman, P. (1998). The Mexican entrepreneur: An ethnographic study of the Mexican impresario. *International Studies of Management and Organization*, 28(2), 97.
- Mayer, R. C., Davis, J. H., & Schoorman, F. D. (1995). An integrative model of organizational trust. *Academy of Management Review*, 20, 709-734.
- Mooradian, T., Renzel, B., & Matzler, K. (2006). Who trusts? Personality, trust and knowledge sharing. *Journal of Management Learning*, 37(4), 523-540.
- Nooteboom, B. (2002). *Trust: Forms, foundations, functions, failures, and figures*. Cheltenham: Edward Elgae.
- Penley, L. & Hawkings, B. (1985). Studying interpersonal communication in organizations: A leadership application. *Academy of Management Journal*, 28, 309-326.
- Roberts, K., & O'Reilly, C. (1974). Measuring organizational communication. *Journal of Applied Psychology*, 59(3), 321-326.
- Rogers, E. (2003). *Diffusion of innovations* (5th Ed.). New York: Free Press.
- Sitkin, S. B., Rousseau, D. M., Burt, R. S., & Cramerer, C. (1998). Editors of special topic forum on trust in and between organizations. *Academy of Management Review*, 23(3), 515-530.
- Six, F., & Nooteboom, B (2005). Trust building actions: A relational signaling approach. Unpublished manuscript. Retrieved from http://www.bartnooteboom.nl/site/index_en.cfm?act=teksten.tonen&parent=4954&varpag=4151
- Srinivas, V. (2000). *Individual investors and financial advice: A model of advice-seeking behavior in the financial planning context*. Unpublished doctoral dissertation, Rutgers University, Newark, NJ.
- Stevens, J. P. (2002). *Applied multivariate statistics for the social sciences* (4th ed.). Mahwah, NJ: Lawrence Erlbaum.
- Szulanski, G. (1996). Exploring internal stickiness: Impediment to the transfer of best practice within the firm. *Strategic Management Journal*, 17(winter), 27-43.
- Tsai, W., & Ghoshal, S. (1998). Social capital and value creation: The role of intrafirm networks. *Academy of Management Journal*, 41, 464-476.
- Tyson, T. (1998). *Working with groups* (2nd ed.) South Yarra, Australia: Macmillan.
- Uzzi, B. (1997). Social structure and competition in interfirm networks: The paradox of embeddedness. *Administrative Science Quarterly*, 42, 35-67.
- Wenger, E. McDermott, R., & Snyder, W. (2002). *Cultivating communities of practice: A guide to managing knowledge*. Boston: Harvard Business School Press
- Zaheer, A., McEvily, B., & Perrone, V. (1998). Exploring the effects of inter-organizational and interpersonal trust on performance. *Organization Science*, 9, 141-159.
- Zand, D. E. (1972). Trust and managerial problem solving. *Administrative Science Quarterly*, 17, 229-239.

Proposed Solutions Toward Inclusive Agricultural Education Programs

Dr. Douglas D. LaVergne, West Virginia University

Dr. Alvin Larke, Jr., Texas A&M University

Dr. Wash A. Jones, Prairie View A&M University

Dr. Chanda D. Elbert, Texas A&M University

Abstract

While schools across the United States are witnessing an influx of students from diverse backgrounds, the need to address the issue of diversity inclusion among teachers is critical for equitable schools. This study explored and analyzed Texas agricultural education teachers' (n = 232) perceptions on proposed solutions to increase diversity inclusion in agricultural education programs. Using a web-based questionnaire, descriptive statistics were used to report demographic and personal characteristics while mean scores were used to assess teachers' perceptions on the proposed solutions. Teachers agreed that: "Agricultural education teachers should become familiar with the students of color represented in their classrooms in order to promote an atmosphere of acceptance and cooperation;" "educators, parents, and policymakers must develop strategies to address the different learning styles of all students;" and "teaching materials should reflect a diverse society in agricultural education."

Introduction

The number of students from different racial and ethnic backgrounds in schools throughout the United States has increased considerably as diversity has become progressively more reflective in public education. In a national report on the condition of education, Planty et al. (2009) reported 24% of all public school students attended schools where the combined enrollment of students of color was at least 75%, compared to 16% of public school students in 1990–91. Conversely, the number of students with disabilities has increased and their time spent in regular education classrooms has increased to 80 % (Biddle, 2006; National Center for Educational Statistics, 2007). Irvine (2003) stated: "most teachers now in classrooms and in teacher education programs are likely to have students from diverse ethnic, racial, language, and religious groups in their classrooms during their careers" (p. x). The increasing diversity of students and the homogenization of public school teachers mean that more and more educators will teach students from diverse backgrounds. Because of the changing demographics in public schools, the agricultural education profession also has begin to reexamine its mission as the profession understands that future teachers and students of agricultural education will be from a broader diversity of individuals. Teachers of agricultural education must be prepared in terms of philosophy, pedagogy, and curriculum to embrace the complexities of an increasingly diverse population and actively work on preparing this population to navigate the waters of agricultural education successfully.

It is widely recognized that agricultural education programs in public schools are experiencing an increased diffusion of students from a variety of backgrounds (Roberts et al., 2008). With this rapidly occurring shift, researchers have made cognizant efforts to examine the relationship in which this phenomena has impacted the profession (Giffing, Warnick, Tarpley, & Williams, 2010; LaVergne, Larke, Elbert, & Jones, 2009). Additionally, the presence of diversity in agricultural education has prompted researchers to recommend greater emphasis in recruitment initiatives to national organizations such as the National Council and National FFA (Kantrovich, 2007; Roberts et al., 2008). However, contrary to this increased awareness, an

investigative effort to discover current and tangible solutions to the recruitment of underrepresented groups in agricultural education has yielded modest results. As such, the current literature based upon this premise, offers strong optimism.

In a study concerning recruitment efforts of Hispanic students, Roberts et al. (2008) discovered that agricultural education programs and the National FFA Organization indeed can be appealing to non-traditional students. The researchers noted that, through a successful implementation of six intervention strategies, guided by Rogers (2003) theories of *Diffusion of Innovations*, an increase number of Hispanic students enrolled in agricultural education programs and participated in FFA activities. “The analysis of this experience demonstrated that, when provided with encouragement, recognition, and resources, agricultural education teachers can enroll Hispanic students and engage them in meaningful FFA activities” (Roberts et al., 2008, p.10). In a case study of successful agricultural teachers’ experiences in recruiting African American students, LaVergne, Larke, Jones, and Elbert (2008) discovered six recruitment strategies that were implemented to counter negative agriculture perceptions. These strategies included: (a) alternative agricultural courses (e.g., canine science, veterinarian technology), (b) making connections of everyday life to agriculture (e.g., bridging the connection between the foods and agriculture), (c) knowledge of various cultures on non-traditional students, (d) modern technology in agricultural based facilities, (e) cross-curriculum recruiting, and (f) community education of local agricultural programs.

Addressing the importance of meeting students with learning disabilities needs in agricultural education also has garnered some attention. Pense, Watson, and Wakefield (2010) reported that a redesigned curriculum should be considered. The researchers declared, “if the curricular needs of specific learning disabilities students in the agricultural education classroom are not met, the agriculture industry risks losing 25% of the future workforce” (p.115). Additionally, the researchers suggested that further studies should investigate ways to train and further develop agricultural educators on accommodating the needs of students with learning disabilities. In additional research, Stair, Moore, Wilson, Croom, and Jayaratne (2010) sought to identify instructional strategies that high school agricultural education teachers used when working with students with disabilities. According to the researchers, strategies used by teachers were: (a) providing hands-on opportunities for students, (b) reading a student’s Individualized Educational Plan (IEP), (c) modified testing, (d) increased time spent with students, (e) close observation during hands-on activities, (f) no penalizing spelling errors, and (g) strategically assigning group work or student collaborations. The researchers also noted that their findings would suggest that agricultural education teachers may need additional training in order to administer the recommended suggestions effectively.

Given the increasing mixture of students in agricultural education classrooms, a lack of an assortment of resources concerning the issue of diversity can exacerbate the difficulties that many agricultural education teachers have with the recruiting and retaining underrepresented groups in agricultural education programs. The ability of agricultural education teachers to teach a wide variety of students is vital to success and practicality of the profession. Whereas the aforementioned studies have provided an excellent example of research in practice, additional resources for concrete solutions to diversity inclusion still exist. This study sought to add underpinning information to this growing paradigm.

Conceptual Framework

Through a review of literature, a conceptual framework was developed (LaVergne, 2008) based on theories associated with Bank's (2008) dimensions of multicultural education, Salend's (2008) principles of inclusion, and Gay's (2000) culturally responsive teaching. Through multicultural education, culturally responsive teaching is the medium by which diversity inclusion occurs. Altogether, diversity inclusion is an educational philosophy that embraces all students by engaging them in educational programs regardless of their race, ethnicity, or exceptionality. The concept mirrors a practical human development approach not only to the educational well-being but also social well-being that calls for more than removing the barriers or fears of a culturally responsive classroom. It requires teachers to be dedicated in bringing about actions to creating a diversity inclusive classroom. It is the proactive approach of recognizing and accepting differences and ensuring that every student in the classroom can be successful.

Underlying the concept is the assertion that diversity inclusion is a frame of mind, more than a list of strategies and recommendations, which guides the educational beliefs to which teachers accede. Diversity inclusive teachers understand their strengths and misunderstandings. They recognize how these strengths and misunderstandings influence their expectations for success and their interactions with the diversity of students in their programs. They recognize that the ultimate goal of a diversity inclusive classroom is not to achieve the cliché of “one program fits all” model, but to create a program where their students have equal opportunities to benefit from everything that the program has to offer. In sum, they understand that diversity inclusion gives everyone a fair dealing.

Because of its originality, previous research on diversity inclusion has generated slight results. In a study of diversity inclusion of North Carolina secondary agricultural educators, Warren and Alston (2007) found that stakeholders, teachers, and students benefit from diversity inclusion in various ways. The researchers noted that diversity inclusion “broadens the perspectives of teachers and students, a characteristic that will be greatly needed...” (p. 76). Research exclusively on diversity has shown a positive impact on students' cognitive and personal development because it challenges stereotypes, broadens perspectives, and sharpens critical thinking skills (Banks, 2008).

While students with disabilities and the special education curriculum continue to be the principal focal point of inclusion, recently, the term has been extended to include the increased cultural/linguistic plurality, coupled with other dimensions along which people may differ (e.g., socioeconomic status, geographical influences, gender, religious sect, etc.) (Salend, 2008). Conversely, public schools now are educating millions of disabled children, and a growing number of them are enrolling in general education courses (Planty et al., 2009). Over the past couple of years, meticulous studies have been conducted concerning teacher attitudes and perceptions towards the inclusion of students with disabilities in regular education classes (Smith, 2007; McLeskey & Waldron, 2007). Underlying the premise of these studies was the fact that the attitudes of teachers play an important role in the success of an inclusive program. If the goal for students with disabilities is in the best interest of teachers and parents, then the proper steps must be taken to ensure adequate resources are provided so that all students will have a chance to succeed.

The Diversity Inclusive Program Model (see Figure 1) is a design that guides the concept of diversity inclusion. As previously mentioned, diversity inclusion encompasses multicultural

education, inclusion, and culturally responsive teaching in a three-part model that highlights the critical infusion in which a diversity inclusive program should exist. Teachers and programs that exist within this area have positive perceptions about (1) the benefits of diversity inclusion; (2) understanding that, because of past perceptions, whether it be from students, teachers, or external factors (e. g., friends, co-workers, parents, etc.) pre-existing barriers may be reason why these particular students are underrepresented in agricultural education, and (3) having an awareness of possible solutions to increase underrepresented group participation in agricultural education. Additionally, teachers who are receptive to a diversity inclusive program have become allies to those who understand that the future success of agricultural education will be determined by how prepared our agricultural educators are in teaching students of color and students with disabilities in our classrooms. The over arching goal of the program model is to formulate an inclusive educational and classroom culture by which all students, regardless of their race, ethnicity, or exceptionality, experience program success.

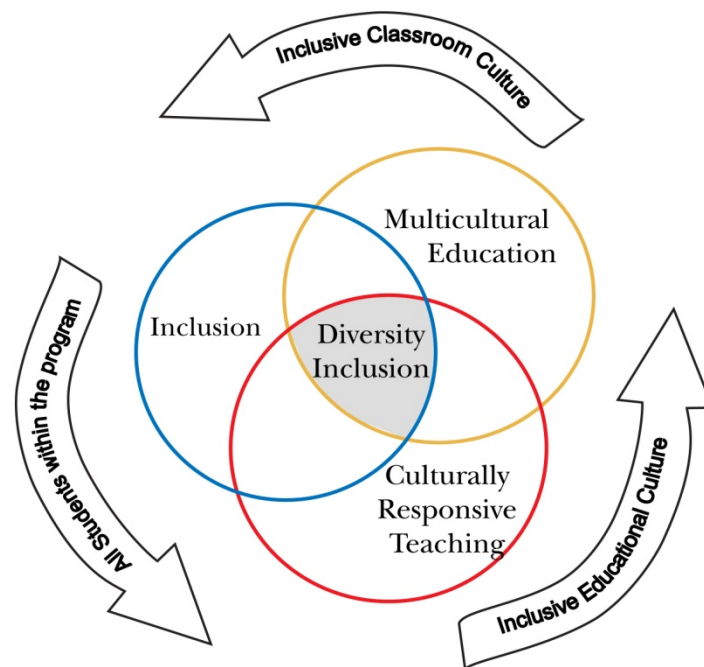

Figure 1. The Diversity Inclusive Program Model.

Purpose and Objectives

The purpose of this study was to explore and analyze Texas agricultural education teachers' attitudes toward diversity inclusion in Texas agricultural education programs. To achieve the purpose of this study successfully, the following research objectives were developed:

1. Identify personal characteristics of the selected Texas agricultural science teachers;
2. Determine Texas agricultural education teachers' perceptions of proposed solutions to increase diversity inclusion in Texas agricultural education programs.

Methodology

Following Dillman's (2007) *Tailored Designed Method* for survey implementation, the researchers implemented this questionnaire via the Internet while using SurveyMonkey.com as the host Web site. The questionnaire was based on previous work by Warren and Alston (2007) concerning diversity and inclusion perceptions of North Carolina agricultural education teachers. Researchers acquired permission to use and modify the instrument. Part one (*Solutions*) consisted of 12 statements designed to gauge participants' perceptions on possible strategies or solutions that would promote diversity inclusion in agricultural education programs; and part two consisted of five items designed to collect demographic information on the agricultural education teachers. A statistical factor analysis was not conducted because the researchers determined the factors conceptually based on the borrowed instrument. Individual statements were identified conceptually as contributing to the construct. Cronbach's alpha coefficient was calculated and reported to describe the internal consistency of the summated scale. The reliability analysis coefficient for the construct was .90. A panel of experts with expertise in diversity and inclusion established content validity. Construct validity confirmed that the questionnaire's score actually reflect the conceptual area that it intended to measure. Evidence of construct validity was collected from the responses and suggestions from the panel of experts and from a pilot test of 15 agricultural teachers not included in the final survey population. The two groups provided input regarding the content and direction of the statements, which added to the accuracy and precise construction of the questionnaire.

The target population consisted of all Texas agricultural education teachers as listed by the Texas Education Agency during the 2006-2007 school year. Because of the unavailability of personal information from the Texas Education Association, access to all 1,732 agricultural education teachers listed by Texas Education Association was not feasible. The accessible population of the study consisted of all Texas agricultural education teachers that had email addresses listed on the JudgingCard.com Website. At the time of selection, 1,500 Texas agricultural education teachers were listed. To ensure that all teachers listed on the website were agricultural science teachers in Texas, cross referencing was used with the Vocational Agriculture Teachers Association of Texas membership roster to ensure validity ($N = 1,500$). Using a sampling formula from Bartlett, Kotrlík and Higgins (2001), researchers used a nonproportional stratified random sample to ensure that all 10 administrative areas as defined by the Texas FFA Association would be represented proportionately in the study. Within each administrative area, researchers randomly selected 32 teachers ($n = 320$).

The questionnaire was administered using a series of e-mails. Participants received a pre-notice/introductory letter outlining the purpose and importance of the study and informing them

that they would receive an e-mail in about one week with instructions on how to complete the questionnaire online. A hyperlink to the questionnaire also would be included in each e-mail correspondence. At the time of the first e-mail, 31 e-mail addresses were invalid. To obtain valid e-mail addresses, the researchers searched district websites and contacted school personnel. After this update, another e-mail was sent, and the e-mail addresses were deemed valid. For the remainder of the data collection phase, the researchers sent reminder e-mails every Monday until the study was concluded. In order to address nonresponse error, the researchers compared respondents' questionnaire return rate before the closing date ($n = 195$) with respondents' questionnaire return rate after the closing date ($n = 37$) (Lindner, Murphy, and Briers, 2001). Using the cutoff date as the independent variable and mean score on the *Solutions* scale as the dependent variable, independent sample t-tests revealed no statistically significant difference ($p < .05$) existed between respondents' mean scores on the construct; deeming the responding sample as a viable representation of the accessible population. The final return rate was 72.5%.

Results

Table 1 shows the frequencies and percentages for the demographic variables reported in the study. Of the respondents, 170 were male, while 45 were female. The majority (90.5%) of the respondents indicated that they were White/European American. The data also indicate that a large percentage (62.8%) of teachers taught in schools located in a rural setting. Regarding teaching experience, fifty-two (24.2%) indicated that they had between 5 and 10 years of teaching experience.

Table 1

Demographic profile of Respondents (n=232)

Demographics	<i>f</i>	%
Gender^a		
Male	170	79.1
Female	45	20.9
Race/Ethnicity^b		
Asian American	1	0.5
Black/African American	2	0.9
Hispanic/Latino American	13	6.2
Native American	4	1.9
White/European American	191	90.5
Demographics		
School Setting^a		
Rural	135	62.8
Urban	32	14.9
Suburban	48	22.3
Years of Teaching Experience^a		

< 5	48	22.3
5-10	52	24.2
11-15	32	14.9
16-20	24	11.2
21-25	27	12.6
> 25	32	14.9
	<i>M</i>	<i>SD</i>
Age ^c	39.36	10.72

Note. ^a Seventeen participants did not respond to this question. ^b Twenty-one participants did not respond to this question. ^c Twenty-three participants did not respond to this question.

Table 2 shows the means and standard deviations for proposed solutions to increase diversity inclusion in Texas agricultural education programs. The statement in which participants scored the highest mean score involving multicultural education was, “Teaching materials should reflect a diverse society in agricultural education” ($M = 2.98$, $SD = .65$). The statement in which participants scored the highest mean score involving agricultural teachers was: “Agricultural education teachers should become familiar with students of color represented in their classrooms in order to promote an atmosphere of acceptance and cooperation” ($M = 3.42$, $SD = .65$). In relation to statewide initiatives, respondents agreed that “For all students to achieve in school, educators, parents, and policymakers must develop strategies to address the different learning styles of all students” ($M = 3.33$, $SD = .63$), and “A state-wide support network for agricultural educators would enhance diversity inclusion in agricultural education” ($M = 2.72$, $SD = .73$). To summarize the information further regarding the proposed solutions that would promote diversity inclusion in agricultural education programs, the researchers computed an overall mean score from the 12 items in the scale. The overall mean for the total group was 2.90 ($SD = .49$).

Table 2

Proposed Solutions to Increase Diversity Inclusion in Agricultural Education Programs (n=232)

Diversity Inclusion	Item	<i>M</i>	<i>SD</i>
Multicultural Education	Teaching materials should reflect a diverse society in agricultural education.	2.98	.65
	Multicultural education can be used to increase the awareness of students of color in relation to diversity	2.91	.62

	Multicultural education can be used to increase the awareness of students with disabilities in relation to diversity.	2.86	.66
	Multicultural education is a strategy that can be utilized to promote an attitudinal change toward diversity inclusion in agricultural education.	2.78	.70
	It is important for colleges and universities to incorporate more multicultural education classes in their preservice teacher preparation curricula.	2.68	.78
	Agricultural education teachers need training in multicultural education.	2.64	.77
Agricultural Teachers	Agricultural education teachers should become familiar with students of color represented in their classrooms in order to promote an atmosphere of acceptance and cooperation.	3.42	.65
	For all students to achieve in school, educators, parents, and policymakers must develop strategies to address the different learning styles of all students.	3.33	.63
	Agricultural educators should encourage and strive to increase students' of color membership in FFA.	3.09	.67
	An increase in recruitment efforts by agricultural educators would enhance diversity inclusion in agricultural education.	2.95	.66
Diversity Inclusion	Item	<i>M</i>	<i>SD</i>
Statewide Initiatives	Mentoring is a strategy that could be utilized to increase diversity inclusion in agricultural education.	2.92	.60
	A state-wide support network for agricultural educators would enhance diversity inclusion in agricultural education.	2.72	.73

Note. Scale: 1.00 to 1.49 = Strongly Disagree, 1.50 to 2.49 = Disagree, 2.50 to 3.49 = Agree, 3.50 to 4.00 = Strongly Agree.

Conclusions

Overall, participants had a high rate of response using an Internet based survey method. This finding adds credence to the study conducted by Ladner, Wingenbach, and Raven (2002)

that concluded that web-based survey instruments provide valid and reliable means of collecting data.

Texas agricultural educators tended to have favorable attitudes toward the proposed solutions to increase diversity inclusion in agricultural education programs. Because the scale addressed both students of color and students with disabilities, findings of this study support previous studies that found that general education teachers can have positive benefits on both students of color and students with disabilities (Smith, 2007; Wood, 2007).

Respondents agreed that agricultural education teachers should become familiar with students of color represented in their classrooms in order to promote an atmosphere of acceptance and cooperation. This finding supports previous studies (Marzano, 2003; McLeskey & Waldron, 2007) indicating that attitudes of teachers play an important role in the success of an inclusive program. If agricultural education teachers truly are dedicated to the success of an inclusive program, they will have to ensure that they become familiar with strategies that will aid them in creating that atmosphere. Although concrete strategies have yet to be determined, agricultural educators must continue to develop the skills for inquiring into the culture and individualities of students that will make up their programs.

Respondents agreed that diversity inclusion in agricultural education could have a positive impact on the entire school community and provide a positive impact on programs across the state. One speculation from this finding is that Texas agricultural education programs could have a greater impact on diversity inclusion than any other school program. Because of the distinctiveness of the profession, many agricultural education teachers model their program's success upon the positive attributes of others (LaVergne, 2008). If more agricultural education teachers include diversity inventiveness, it seems possible that other agricultural education teachers will follow suit.

Respondents believed that an increase in recruitment efforts by agricultural educators would enhance diversity inclusion in their programs. This finding adds supporting evidence to the study by LaVergne (2008) that reported agricultural educators believed that a lack of information about agricultural education has an impact on students' of color perceptions of their programs. Considering this finding, agricultural educators should revisit their recruitment efforts and develop strategies that would foster a greater opportunity for students of color to become involved in agricultural education, consequently creating a positive perception of the program. This finding also adds relevance to studies such as Warren and Alston (2007) and Roberts, Hall, Briers, Gill, Shinn, Larke, and Jaure (2008) which examined the link between teachers and students in relation to the recruitment of diverse populations into agricultural education.

Multicultural education was viewed as a tool to increase the awareness of students of color and students with disabilities in relation to diversity inclusion in agricultural education programs. The finding affirms the critical need of developing culturally responsive teachers. Culturally responsive teaching is important for the success of students of color and students with disabilities in agricultural education. Gay (2000) emphasized that a continuation of ignorance about equitable pedagogy and cultural difference would be harmful to diverse students.

Texas agricultural education teachers believed that teaching materials should reflect a diverse society in agricultural education. Although this finding indicates respondents' requests to have teaching materials that reflect a diverse society, Banks (2008) cautioned educators not to stop there:

In many school districts as well as in popular writings, multicultural education is viewed only (or primarily) as content integration. This narrow conception of multicultural

education is a major reason that many teachers believe that multicultural education is irrelevant to them and their students (p.31).

Agricultural education teachers need to understand that pictures and books depicting underrepresented groups in agricultural education will provide some assistance in promoting diversity inclusion but will not be the “end-all” solution to recruiting and retaining diverse students into their programs. Teachers must make genuine efforts to promote a total multicultural inclusive classroom that will foster acceptance and embrace the differences in students.

Mentoring was seen as a strategy to increase diversity inclusion in agricultural education programs. This finding supports what Banks (2008) called an empowering school climate and culture. Teachers, administrators, and parents must work collectively to make sure schools create an atmosphere that promotes diversity and inclusiveness. Agricultural education teachers must understand that their goal to promote diversity inclusion is not an isolated mission but rather a school-wide effort.

Implications and Recommendations

Texas agricultural education teachers tended to have favorable attitudes toward diversity inclusion in agricultural education programs. Based on these findings, efforts should be made by agricultural education teachers to ensure that students of color and students with disabilities are persuaded to enroll in agricultural education courses. Beginning introductory courses in any agricultural education program could provide excellent opportunities for students to be introduced to agricultural education. However, as noted in previous research (LaVergne, 2008), the agricultural education profession has not produced substantial evidence that supports this recommendation. In order to maximize the resources of our profession in recruiting individuals from various backgrounds, agricultural educators should not discount the potential impact that an introductory course can provide. Additionally, local FFA chapters could be utilized as a recruitment tool for students of color and students with disabilities. If, as the literature suggests, Texas agricultural education teachers do favor diversity inclusion, then respondents should promote and encourage greater participation of diverse students into agricultural education programs.

As previously mentioned, respondents agreed that teaching materials should reflect a diverse society in agricultural education. One implication from this finding is that course materials in agricultural education fail to imitate the demographic shifts occurring in schools and society. Based on this implication, the authors recommend that agricultural educators continue to examine text books, course materials, and other agricultural education related material to see if its contents are inclusive of images of students of color and students with disabilities. It also would be beneficial for agricultural educators to seek out other agricultural education related teaching materials with model inclusive material if possible, so that comparisons between levels of inclusive content can be made.

Because of the success of using a web-based survey, researchers should promote and encourage the use of the Internet as a reliable and valid tool for accessing a wide range of individuals for conducting social science research. Additionally, research of a qualitative nature should be conducted with agricultural education teachers to develop effective strategies to increase diversity inclusion in agricultural education programs. Case studies involving successful inclusive programs could provide strategies and recommendations to other teachers as well.

References

- Banks, J. A. (2008). *An introduction to multicultural education*. Boston, MA: Allyn and Bacon.
- Bartlett, J. E. II, Kotrlik, J. W., & Higgins, C. C. (2001). Organizational research: Determining appropriate sample size in survey research. *Information Technology, Learning, and Performance Journal*, 19 (1), 43-50.
- Biddle, S. (2006). Attitudes in Education. *The Science Teacher*, 73(3), 52–56.
- Dillman, D. A. (2007). *Mail and Internet surveys: The tailored design method*. Hoboken, NJ: John Wiley & Sons, Inc.
- Gay, G. (2000). *Culturally responsive teaching: Theory, research, and practice*. New York: Teachers College Press.
- Giffing, M.D., Warnick, B.K., Tarpley, R.S., & Williams, N.A. (2010). Perceptions of agriculture teachers toward including students with disabilities. *Journal of Agricultural Education*, 51(2), 102-114. doi: 10.5032/jae.2010.02102
- Irvine, J. J. (2003). *Educating teachers for diversity: Seeing with a cultural eye*. New York: Teachers College Press.
- Jones, K.R., & Bowen, B.E. (1998). A qualitative assessment of teacher and school influences on African American enrollments in secondary agricultural science courses. *Journal of Agricultural Education*, 39(2), 19-29.
- Kantrovich, A. J. (2007). *A national study of the supply and demand for teachers of agricultural education from 2004-2006*. Morehead, KY: Morehead State University.
- KewalRamani, A., Gilbertson, L., Fox, M. A. & Provasnik, S. (2007). Status and trends in the education of racial and ethnic minorities. Retrieved from: <http://nces.ed.gov/pubs2007/2007039.pdf>
- Ladner, M., Wingenbach, G., & Raven, M. (2002). Internet versus paper based data collection methods. *Proceedings of the 52nd Southern Agricultural Education Research Conference*, Orlando, FL, 52, 40-51.
- LaVergne, D. D. (2008). *Perceptions of Texas agricultural education teachers regarding diversity inclusion in secondary agricultural education programs* (Unpublished doctoral dissertation). Texas A&M University, College Station.
- LaVergne, D.D., Larke, Jr., A., Jones, W.A., & Elbert, C.E. (2008). A Case study of agricultural teacher's experiences in recruiting non-traditional students into agricultural education: one response for african-american students. *The Journal of the Texas Alliance of Black School Educators*, 2(1), 21-28.
- Lindner, J. R., Murphy, T. H., & Briers, G. (2001). Handling nonresponse in social science research. *Journal of Agricultural Education*, 42(4), 43-53.
- Marzano, R. J. (2003). *What works in schools: translating research into action*. Alexandria, VA: Association for Supervision and Curriculum Development.
- McLeskey, J., & Waldron, N. L. (2007). Making differences ordinary in inclusive classrooms. *Intervention in School and Clinic*, 42(3), 162-168.
- National Center for Educational Statistics. (2007). The condition of education 2007. Retrieved from: http://nces.ed.gov/programs/coe/2007/pdf/05_2007.pdf
- Pense, S.L., Watson, D.G., & Wakefield, D.B. (2010). Learning disabled student needs met through curriculum redesign of the illinois agricultural education core curriculum. *Journal of Agricultural Education*, 51(2), 115-126. doi: 10.5032/jae.2010.02115
- Planty, M., Hussar, W., Snyder, T., Kena, G., KewalRamani, A., Kemp, J., Bianco, K., Dinkes, R. (2009). *The Condition of Education 2009* (NCES 2009-081). National Center for

Education Statistics, Institute of Education Sciences, U.S. Department of Education.
Washington, DC.

- Rogers, E. M. (2003). *Diffusion of innovations* (5th Ed.). New York: Free Press.
- Roberts, T. G., Hall, J. H., Briers, G. E., Gill, E., Shinn, G. C., Larke, Jr., A & Jaure, P. (2008). Engaging Hispanic students in agricultural education and the FFA: A three-year case study. *Research Proceedings of the 2008 American Association for Agricultural Education Conference*, Reno, NV, 810-823.
- Salend, S. J. (2008). *Creating inclusive classrooms: Effective and reflective practices*. (6th ed.). Upper Saddle River, NJ: Pearson Prentice Hall.
- Scott, F., & Lavergne, D. (2004). Perceptions of agriculture students regarding the image of agriculture and barriers to enrolling in an agricultural education class. *Journal of Southern Agricultural Education Research* 54 (1), 48-59.
- Smith, B. A. (2007). Increasing the comfort level of teachers toward inclusion through use of school focus groups. *ProQuest Information and Learning Company*. (UMI No. 3264498)
- Stair, K.S., Moore, G.E., Wilson, B., Croom, B., & Jayaratne, K.S.U. (2010). Identifying confidence levels and instructional strategies of high school agricultural education teachers when working with students with special needs. *Journal of Agricultural Education*, 51(2), 90-101. doi: 10.5032/jae.2010.02090
- Warren, C. K., & Alston, A. J. (2007). An analysis of diversity inclusion in North Carolina secondary agricultural education programs. *Journal of Agricultural Education*. 2, (2) 66-78.
- Williams, B.F. (January, 1992). Changing demographics: Challenges for educators. *Intervention in School and Clinic*, 27 (3), 18-20, and 22.
- Wood, M. J. (2007). Teacher efficacy, teacher attitudes towards inclusion and teachers' perspectives of training needed for successful inclusion. *ProQuest Information and Learning Company*. (UMI No. 3259647)

Multicultural Competence: A Case Study of Teachers and their Student Perceptions

*Stacy K. Vincent, University of Kentucky
Robert M. Torres, University of Arizona*

Abstract

The purpose of this study is to describe the level of multicultural competence among secondary agriculture teachers in schools with a minimum of 30% ethnic minority student enrollment. Using the Multicultural Skills Awareness and Skill Survey – Teacher Form, teachers assessed their multicultural competence as did their students assess the teacher’s multicultural competence. For comparison purposes, teachers were grouped by the ethnic diversity of their FFA chapter membership: diverse and non-diverse FFA membership. From the findings, teachers within a diverse FFA membership had a higher multicultural competence level (by the teacher and the students) than did teachers within a non-diverse FFA membership. When combining both teacher groups together, the results suggest that students perceive their teachers to be more multicultural competent than the teachers perceive themselves. The results and recommendations are provided as to the development of teachers that are multicultural competent.

Introduction

The United States is growing and transitioning into a more pluralistic country (Villegas & Clewell, 1998; Woods, 2004; Census, 2008). In 2008, the United States Census Bureau (USCB) issued a report detailing population predictions by ethnicity from 2010 to 2050. The USCB predict that the White population will have the lowest increase in population (1.2%; 2.48 million) over the 40-year time-period as compared to other ethnic groups. By contrast, the Hispanic population is anticipated to have the largest increase (167.1%; 83 million) followed by Asians (137.3%; 20 million) and African Americans (36.7%; 14 million).

This dramatic change in ethnic composition is expected in public school classrooms across the United States as well (Diller & Moule, 2005; Luft, 1996; Milner, Flowers, Moore, Moore, & Flowers, 2003). Minority students are projected to comprise approximately 48% of the nation’s school age children by 2020 (Pallas, Natriello, & McDill, 1989). Projections suggest, however, that teacher populations will not reflect a similar demographic change.

The lack of minority teacher representation exists in agricultural education as well. In a study of the 2005 preservice agriculture teacher population, 93.4% of the respondents reported to be White, followed by 2.4% Hispanic, 1.4% African American and 0.9% Asian (Rocca & Washburn, 2008). This trend is expected to continue as 95% of all teacher education students hail from rural and suburban areas, which subsequently represent a majority of White non-Hispanic populations (Dilworth, 1989). Although the Dilworth report is dated and includes all disciplines, membership data within the agricultural education discipline itself mirror the Dilworth publication (Kantrovich, 2007; Rocca & Washburn, 2008).

As the United States continues to become more ethnically diverse, educators will be called on to teach more students from diverse cultures (Diller & Moule, 2005). It is not sufficient to merely expect students to accept the same antiquated models of agricultural education programs or for schools to be able to hire a few ethnically diverse teachers to meet the need (2005). Instead, a change in cultural sensitivity is needed in order to effectively teach ethnically and culturally different students (Banks, 1993). Adoption of the concept of multicultural competence is necessary in order to accomplish the vision of Banks' (1993) and Diller and Moule's (2005). Are agriculture teachers in secondary schools culturally sensitive to the needs of their students? Does cultural sensitivity affect the ethnic enrolment in an agriculture program, which inadvertently affects the membership in the local FFA chapter?

Theoretical Framework

To understand a teacher's level of multicultural competence, this study utilized a theory from counseling psychologists called Multicultural Competence. Multicultural Competence is the ability to engage in actions or create conditions that maximize the optimal development of individuals or individual systems (Sue & Sue, 2008). This is developed through an individual's acquisition of awareness, knowledge, and skills needed to function effectively in a pluralistic society; and on an organizational/societal level, advocating effectively developing new theories, practices, policies, and organizational structures that are more responsive to all groups (Sue, 2001).

Banks (1995) explains the importance of education, in the form of the three constructs of multicultural competence. The first construct, awareness, describes ethnic pluralism as a growing societal reality that influences the lives of young people, while the second construct, knowledge, states that in one way or another, individuals receive knowledge or beliefs, sometimes invalid, about ethnic and cultural groups. The final construct, skills, says that beliefs and knowledge about ethnic and cultural groups limit the perspectives of many and make a difference, often a negative one, in the opportunities available to individuals representing different ethnic groups (Banks, 1995).

In order to visually explain the theory of multicultural competence and its effects on an individual/society, Sue, Arrendondo, and McDavis (2002) developed a Tripartite Model of Multicultural Counseling Competencies, but following several issues concerning the incorporation of psychology, Sue (2001) developed the multidimensional Model for Developing Cultural Competence (MDCC). The MDCC consists of three primary dimensions of multicultural competence: specific racial/cultural group perspectives, components of cultural competence, and foci of cultural competence (see Figure 1.1). Each cell in the model represents a combination of the three major dimensions. Dimension one pertains to acknowledgement of races or cultures while dimension two composes of the constructs from the multicultural counseling competencies: knowledge, beliefs, and skills (Sue et al., 1998). The foci of dimension three examine the person versus the organizational systems of analysis. The work on multicultural competence begins, and typically focuses, on the individual level (Sue et al., 1998).



The work on multicultural competence begins and, typically, focuses on the individual level (Sue et al., 1998). Development of multicultural competence along dimension 3 proceeds in a concerted, hierarchical fashion along four main foci: individual, professional, organizational, and societal levels (Sue, 2001). This study examines the individual and professional foci of dimension 3.

Purpose and Research Objectives

The purpose of this study was two-fold. First, this study sought to describe the constructs of multicultural competence in school-based agriculture teachers and their relationship to the ethnic diversity of local FFA membership in selected high schools. Additionally, this study

examined the constructs of multicultural competence in school-based agriculture teachers, as perceived by their students, in relationship to the ethnic diversity of local FFA membership in selected high schools. The following research objectives guided this study.

1. Compare the level of multicultural competence held by school-based agriculture teachers by the ethnic diversity of the local FFA membership.
2. Compare the level of multicultural competence held by school-based agriculture teachers, as perceived by their students, by the ethnic diversity of the local FFA membership.
3. Compare the level of multicultural competence held by school-based agriculture teachers with students' perception of their agriculture teacher.

Methods and Procedures

The study utilized descriptive, correlational research methods. Descriptive, correlational research is a type of research that consists of “a set of concepts and methods used in organizing, summarizing, tabulating, depicting, and describing collections of data” (Shavelson, 1996, p. 8).

The sample used this study were school-based agriculture teachers in ethnically diverse schools and students enrolled in the teachers' programs during the 2009 – 2010 academic year. The demographic characteristics of the teachers were White males with at least four years of teaching experience in the selected rural school. The students had each completed a minimum three years under the tutelage of the teacher and were members of the local FFA chapter. The rural schools that each teacher was selected from, as defined by Elder (1992), contained a 30% minimum ethnic minority enrollment. In order to have a critical mass to create an environment that supports multicultural competence, 30% of the population must be a specific minority (Abreu, Chung, & Atkinson, 2000). By selecting schools with a 30% ethnic minority enrollment, each agriculture program had the potential to have a critical mass representation within their agriculture program and FFA membership. This cannot be assumed among agriculture programs in schools with less than 30% ethnic minority enrollment.

Public school districts in Missouri and its contiguous states served as the frame for this study ($N = 3,681$). The National FFA Organization, the National Center for Educational Statistics, and the Council of Chief State and School Officers assisted in narrowing the frame. Only ten schools ($n = 10$) were purposefully selected to comprise the sample due to criteria determined earlier: the cost of traveling to each school for data collection and the lack of representation of diverse ethnic FFA chapter memberships in the selected states. Once schools were selected, ethnicities in the FFA membership were identified. Half of the teachers and their students were labeled diverse as defined by having a minimum of 30% ethnic diverse membership in FFA and the remaining half of teachers and their students were identified as non-diverse, defined as having less than 30% ethnic diverse membership in FFA. The student demographics represented high school junior and senior students who were completing or had completed three years of agricultural education. The ethnic compositions of the student sample were Black and White.

The Multicultural Awareness-Knowledge-Skills Survey: Teacher Form (MAKSS-T) was developed by D'Andrea, Daniels, and Noonan (1994). The MAKSS-T is a derivative of the Multicultural Awareness-Knowledge-Skills Survey: Counselor Edition (MAKSS-CE) which was designed to evaluate counseling psychologists' effectiveness to counsel patients who were

culturally different than themselves (1991). The MAKSS-T is designed to assess the multicultural competence level of teachers who were or would be teaching in a classroom composed of different ethnicities (D'Andrea et al. 2003). The MAKSS-T composed of 37 statements and assesses the three constructs of multicultural competence: awareness, knowledge, and skills. When summated, the three constructs provide a score of an individual's overall level of multicultural competence. The teacher questionnaire asked the teacher to rate their competence level among various statements while the student questionnaire asked the students to rate their teacher's competence level among various statements. Each teacher and student rated the competence score to the various statements on a 4-point Likert scale ranging from "No Competence" to "Excellent Competence".

A panel of experts ($n = 8$) consisted of university faculty members representing agricultural education departments and education colleges from four different universities. The committee reviewed the MAKSS-T for face and content validity. A pilot study of the questionnaires was conducted with secondary agriculture teachers ($n = 32$) and students ($n = 21$) in public school districts in the state of Kentucky. Teachers and students were selected based upon their similarity to the study sample. However, the teachers and students did not reside at a school above a 30% critical mass in ethnic enrollment. Cronbach's Alpha was utilized to describe the reliability of the questionnaire for the teacher version and the student perception version. Results of the Cronbach's Alpha provide the overall teacher version of the MAKSS-T as .89 and the overall student perception version as .88 (see Table 1). The overall score and each construct of the teacher and student questionnaire was considered acceptable (Nunnally, 1978).

Table 1

Cronbach's Alpha Reliability Estimates of the Teacher and Student Questionnaire

Questionnaire Section	Teacher Version ($n = 27$)	Student Version ($n = 21$)
Constructs		
Awareness	.81	.91
Knowledge	.92	.96
Skill	.85	.72
Overall	.89	.88

The teachers and students were assessed near the beginning of the calendar year, prior to state accountability testing windows and organized activities related to the student's active youth organization. Data were collected using a simple distribution of the instrument to each teacher and their students of three and four years.

Following the collection period, data were coded and entered into SPSS. Descriptive statistics of central tendency and variability were calculated to summarize the data. For each group comparison, effect size was calculated using Cohen's (1988) d and magnitude interpreted by Thalheimer and Cook (2002) as: negligible ($d < .15$), small ($d < .40$), medium ($d < .75$), large ($d < 1.10$), very large ($d < 1.45$), and huge ($d > 1.45$).

Results

Research objective 1 sought to compare teachers' multicultural competence by ethnic diversity of the local FFA membership. To compare constructs of multicultural competence (awareness, knowledge, skill, and overall), means and standard deviations were provided. Negligible, medium, and large effect sizes were found in the group comparisons.

The results of Table 2 display teachers' multicultural competence by ethnic diversity of the local FFA membership. In each construct of multicultural competence teachers in a diverse FFA chapter reported a higher mean score. Within each multicultural competence constructs, only the skill construct ($d = 0.81$) and the overall multicultural competence ($d = 0.75$) displayed a large effect size. The remaining two constructs (awareness and knowledge) presented a medium ($d = 0.73$) and negligible ($d = 0.14$) effect size (see Table 2).

Table 2

Teachers' Multicultural Competence by Ethnic Diversity of the Local FFA Membership

Construct ^a	Diverse ($n = 5$)		Non-Diverse ($n = 5$)		Cohen's d
	Mean	SD	Mean	SD	
Awareness	3.13	0.93	3.04	0.44	0.14 ^b
Knowledge	3.32	0.36	3.04	0.49	0.73 ^c
Skill	3.06	0.28	2.79	0.45	0.81 ^d
Overall	3.18	0.22	2.95	0.43	0.75 ^d

^aScale based on: 1 = None; 2 = Limited; 3 = Good; 4 = Excellent; Thalheimer & Cook's (2002) descriptors for describing Cohen's d : ^b = negligible; ^c = medium; ^d = large;

Objective 2 sought to compare the teachers' multicultural competence, as perceived by their students, by the ethnic diversity of the local FFA membership. To compare the constructs of multicultural competence (awareness, knowledge, skill, and overall), means and standard deviations were provided. Small and medium effect sizes were found in the group comparisons.

The results of research objective 2 are displayed in Table 3. Students within diverse FFA chapters perceived their teacher to have a higher level of multicultural competence than students in non-diverse FFA chapters perceived their teacher. When comparing the teacher groups, awareness ($d = 0.51$) displayed a medium effect size. Students' perception of their teacher's Knowledge ($d = 0.20$), Skill ($d = 0.26$), and overall multicultural competence ($d = 0.37$) displayed a small effect size.

Table 3

Students' Perception of Teacher's Multicultural Competence by Ethnic Diversity of the Local FFA Membership

Construct ^a	Diverse ($n = 5$)		Non-Diverse ($n = 5$)		Cohen's d
	Mean	SD	Mean	SD	
Awareness	3.17	0.49	2.90	0.59	0.51 ^c
Knowledge	3.31	0.70	3.20	0.45	0.20 ^b
Skill	3.25	0.60	3.08	0.74	0.26 ^b
Overall	3.25	0.52	3.06	0.52	0.37 ^b

^aScale based on: 1 = None; 2 = Limited; 3 = Good; 4 = Excellent; Thalheimer & Cook's (2002) descriptors for describing relative size of Cohen's d : ^b = small; ^c = medium;

Research objective 3 compares agriculture teacher groups and the students' perception by multicultural competence (awareness, knowledge, skill, and overall). To compare the constructs of multicultural competence (awareness, knowledge, skill, and overall) means and standard deviations were provided. Negligible, small, and medium effect sizes were found (see Table 4).

A medium effect size ($d = 0.41$) was exhibited between the teachers and the students perceived teacher's skill exhibited (see Table 4). A small effect size was observed in the overall multicultural competence rating ($d = 0.22$). Both, knowledge ($d = 0.13$) and awareness ($d = 0.06$) constructs displayed a negligible effect size.

Table 4
Comparison of Teacher Multicultural Competence and Students' Perceived Rating

Construct ^a	Teacher ($n = 10$)		Student ($n = 136$)		Cohen's d
	Mean	<i>SD</i>	Mean	<i>SD</i>	
Awareness	3.09	0.31	3.06	0.55	0.06 ^b
Knowledge	3.19	0.44	3.27	0.61	0.13 ^b
Skill	2.92	0.38	3.18	0.66	0.41 ^d
Overall	3.06	0.12	3.17	0.53	0.22 ^c

^aScale based on: 1 = None; 2 = Limited; 3 = Good; 4 = Excellent; Thalheimer & Cook's (2002) descriptors for describing relative size of Cohen's d : ^b = negligible; ^c = small; ^d = medium

Conclusions/Implications/Recommendations

From this finding, it is concluded that agriculture teachers within a diverse FFA chapter membership setting expressed a greater sense of multicultural competence than did their counterparts. This finding supports Milner et al. (2000) who found characteristics of multicultural competence existing among teachers who surround themselves with culturally different students. In this study, each teacher taught at an ethnically diverse high school. However, ethnically diverse students are enrolled in diverse FFA chapters. Therefore, it can be implied that teachers in diverse FFA chapters are more aware, knowledgeable, and have more skill with relating to students of different cultures. In order to increase the ethnic diversity in FFA chapters, it is recommended that agriculture teacher educators prepare students to become multicultural competent. This does not occur in the presence of a single course in multicultural education (Ford, 1992). Rather, agriculture teacher educators must incorporate multicultural practices throughout undergraduate and graduate courses. Multicultural practices could include, but are not limited to, exploration of beliefs and biases toward groups who are culturally different from the student, journaling, creative projects, philosophical statements, immersion activities, and student interviews.

Additionally, it is concluded that agriculture teachers within diverse FFA chapters have a higher multicultural knowledge score than teachers in non-diverse FFA chapters. According to Milner et al. (2000), teachers with increased knowledge extend themselves beyond the realm of classroom instruction. Therefore, it is implied that teachers in a diverse FFA chapter extend beyond the classroom and into extracurricular school and community events that represent diverse ethnic cultures. Further research is recommended that differentiate the school and community involvement of teachers in diverse and non-diverse FFA chapters.

Another recommendation is that agriculture teachers strive to recruit students that mirror the ethnic cultures represented in the community and school. The recruitment of students from diverse ethnic cultures can be obtained through engagement in community activities such as churches, festivities, and events that involve the cultures of the school. Furthermore, teachers must seek after and meet with students that are culturally different from themselves. The interaction must provide students with assurance of positive experiences and minimize negative perceptions.

Teachers within diverse FFA chapters had a higher skill rating than teachers within non-diverse FFA chapters. In other words, the conclusion suggests that when confronted with classroom issues among students who are culturally different than themselves, teachers in diverse FFA chapters have more confidence. This conclusion is consistent with D'Andrea et al. (2003). In their study, D'Andrea et al. found that teachers with a higher skill in multicultural competence were better able to relate to and manage students of cultures different from the teacher (2003). It is implied that teachers within diverse FFA chapters can relate with and manage ethnically diverse classrooms better than teachers within non-diverse FFA chapters. D'Andrea et al. (1991) suggest that increased multicultural competence comes with practice. Therefore, it is recommended that agriculture teacher educators provide preservice teachers with immersion exercises and clinical hours in ethnically diverse classrooms. Agriculture teacher educators should educate and find approaches that raise secondary agriculture teachers' multicultural competence. Collaboration is recommended between agriculture teacher educators and faculty in the field of multicultural education to restructure undergraduate courses to include lessons and assignments that further develop multicultural competence in students. In addition, it is recommended that these collaborations extend into research that describe, explain, and predict effective multicultural competent strategies in school-based agricultural education.

The primary ethnic minority examined in this study was African American. However, the multidimensional model for Developing Cultural Competence (MDCC) entails ethnicities besides African American. Therefore, research is recommended that assess multicultural competence toward students of all races and cultures. Other races modeled in the MDCC include Latino American, Asian American, Native American, and European American students.

Multicultural competence does not end with ethnicity. Sue's model (2001) is a reflection of race or culture and a secondary school is a complex assortment of cultures and cultural bias (Bennett, 2001; Crawley and Ritsema 2006; and Kinney 1999). It is recommended that future research examine other student populations that may not feel welcome within the doors of agriculture classrooms (Eckert, 1989; Kinney, 1993; Wilkins, 2008). Stereotypes beyond ethnicity, but more toward social identity (Perry, 2002) should be challenged.

The findings from the students' perception suggest that students can identify a teacher who is and is not multicultural competent. This conclusion supports findings from Constantine (2002) regarding clients' perceptions of their counselors. In Constantine's study, clients were able to identify counselors who were multicultural competent. Perhaps students identify multicultural competence through interactions with other teachers in the school and by observing differences between teachers who are and are not multicultural competent. It could be that multicultural competent teachers exhibit knowledge, awareness, and skill in their classroom

instruction; resulting in an inviting classroom environment for all students. Therefore, it is recommended that teacher organizations, such as National Education Association, Association for Career and Technical Education, and National Association of Agricultural Educators, inquire about students' perceived strategies used by teachers deemed multicultural competent. Furthermore, these organizations are encouraged to provide opportunities for students to recognize teachers for their ability to teach students who are culturally different than themselves. Additionally the National FFA Organization should reinstate the H. O. Sargent award to students and teachers who exhibit multicultural competence.

Students perceive their teacher's multicultural competence from observations in the classroom. This is a reflection of the teacher as a professional. Because Dimension 3 of the MDCC (Sue, 2001) is hierarchical, it can be concluded that a multicultural competent professional is also a multicultural competent individual (Sue, 1998). Thus, concluding that students in diverse FFA chapters perceive their teacher to be a multicultural competent individual and professional.

African American students represented the largest ethnic minority sample in this study. According to Brooks (2006), cultural differences exhibited by African Americans occur every day during cultural practices, family activities, community events, and religious ceremonies. Based upon the findings, it is concluded that African American students identified multicultural competence in the teachers in diverse FFA chapters. It is posited that these teachers are immersing themselves in activities similar to the Brooks' (2006) study, resulting in an ethnically diverse classroom and FFA chapter. As a result of the implication, recommendations are provided for immersing teachers into cultures different from their norm. Teachers should be expected to obtain a set number of after school hours in student activities beyond their discipline area and serve on organizations and attend community events that encompasses student ethnicities different from themselves. Prior to school-based teaching experiences, agriculture teacher educators should encourage preservice teachers to become members of organizations that extend beyond the realm of agriculture. In addition, research should examine activities that teachers in diverse FFA chapters immerse themselves in that would deem them multicultural competent.

Based upon the findings in research objective 3, it is concluded that for multicultural awareness and knowledge the teachers' rating reflects the students' perception of their teacher. This implies that selected agriculture teachers' awareness and knowledge in multicultural competence is showcased during their interaction with students. Teachers should strive to increase their students' perception of their multicultural competence. Suggestions for improving a school-based agriculture teachers' awareness and knowledge are to learn as much as possible about the cultural backgrounds of each student through student interviews and SAE visits and pronounce student names correctly and understand the interpretive meaning of name. Enhancing students' self-image and motivation through encouragement to be prideful of their cultural identity and seeking help from school counselors in better understanding each student's background and learning capabilities will serve beneficial in developing a teachers' awareness and knowledge in multicultural competence.

Another conclusion from the findings is that students perceive their teachers' multicultural competence to be higher than the teachers self-rating. It is posited that the teachers

have established a developed trust and respect from their completer/concentrator students, resulting in a higher student perception than teacher rating. It is recommended that secondary agriculture teachers utilize the students' higher perception for recruiting ethnically diverse students, developing a pluralistic FFA chapter, and ending racial prejudices that may exist.

Additional research is needed to determine if a significant difference exists among students and teachers in diverse and non-diverse FFA chapters. Inferential statistics could not be used because the sample size of teachers ($n = 10$) and students ($n = 135$) were small and not proportional. Furthermore, additional research investigating agriculture teachers multicultural competence as perceived by students not enrolled in secondary agricultural education is recommended. The study recommended provides an understanding of ethnic minority students' perception of the agriculture teacher.

References

- Abreu, J. M., Chung, R. H. G., & Atkinson, D. R. (2000). Multicultural counseling training: Past, present, and future direction. *The Counseling Psychologist, 28*(5), 641-656. doi: 10.1177/0011000000285003
- Banks, J. A. (1993). Multicultural education: Historical development, dimensions, and practice. *Review of Research in Education, 19*, 3-49.
- Banks, J. A. (1995). Multicultural Education: Historical Development, Dimensions, and Practice. In J. A. Banks & C. A. M. Banks (Eds.). *Handbook of Research on Multicultural Education* (pp. 3-24). New York: Macmillan.
- Bennett, C. (2001). Genres of research in multicultural education. *Review of Educational Research, 71*(2), 171-217.
- Brooks, W. (2006). Reading representations of themselves: Urban youth use culture and African American textual features to develop literary understandings. *Reading Research Quarterly, 1*(3), 372-392. doi: 10.1598/RRQ.41.3.4
- Bruner, J. S., & Tagiuri, R. (1954). The perception of people. In G. Lindzey (Ed.), *Handbook of Social Psychology, 2nd Edition*. Cambridge, MA: Addison Wesley.
- Constantine, M. G. (2002). Predictors of satisfaction with counseling: Racial and ethnic minority clients' attitudes toward counseling and ratings of their counselors' general and multicultural counseling competence. *Journal of Counseling Psychology, 49*(2), 255-263. doi: 10.1037/0022-0167.49.2.255
- Cohen, J. (1988). *Statistical power analysis for the behavioral sciences* (2nd Ed.). Hillsdale, NJ: Erlbaum.
- Crawley, W., & Ritsema, J. (2006). Strategies in developing the student self: The production and maintenance of collective identities in a Midwest school setting. *Journal of Knowledge and Bet Practices in Juvenile Justice and Psychology, 1*(1), 25-34.

- D'Andrea, M., Daniels, J., & Heck, R. (1991). Evaluating the impact of counseling training. *Journal of Counseling & Development, 70*, 143-151.
- D'Andrea, M., Daniels, J., & Noonan, M. J., (1994). *The multicultural awareness, knowledge, and skills survey-Teachers form (MAKSS-Form T)*. Honolulu, HI: University of Hawaii, College of Education.
- D'Andrea, M., Daniels, J., & Noonan, M.J., (2003). New developments in the assessment of multicultural competence: The multicultural awareness-knowledge-skills survey– Teachers form. In D.B. Pope-Davis, et al. (Ed.), *Handbook of multicultural competencies: In counseling & psychology* (154-167). Thousand Oaks, CA: Sage Publications.
- Diller, J., & Moule, J. (2005). *Cultural competence: A primer for educators*. Belmont, CA: Thomson Wadsworth.
- Dilworth, M. E. (1989). Recruitment: The good news and the bad news on the teaching profession. In A.M. Garibaldi (Ed.), *Teacher recruitment and retention: With a special focus on minority teachers* (8-11). Washington, DC: National Education Association.
- Eckert, P. (1989). *Jocks and burnouts: Social categories and identity in the high school*. New York: Teacher College Press.
- Ford, B. A. (1992). Multicultural education training for special educators working with African American youth. *Exceptional Children, 59*(2), 107-114.
- Grant, P. R., & Holmes, J. G. (1981). The integration of Implicit Personality Theory schemas and stereotype images. *Social Psychology Quarterly, 44*(2). 107 – 115.
- Hamilton, D. L. (1979). A cognitive-attributitional analysis of stereotyping. In L. Berkowitz (ed.), *Advances in Experimental Social Psychology*. New York: Academic- Press.
- Kantrovich, A. J. (2007). *A national study of the supply and demand for teachers of agricultural education from 2004-2006*. American Association for Agricultural Education.
- Kinney, D. A. (1993). From “nerds” to “normals”: The recovery of identity among adolescents from middle school to high school. *Sociology of Education, 66*(1), 21-40.
- Kinney, D. A. (1999). From “headbangers” to “hippies”: Delineating adolescents' active attempts to form an alternative peer culture. In J. A. McLellan & M. J. V. Pugh, (Eds.) *The Role of Peer Groups in Adolescent Social Identity: Exploring the Importance of Stability and Change*. (pp. 21–35). San Francisco, CA: Jossey-Bass.
- Luft, V. D. (1996). Extent to which cultural diversity is addressed in secondary agricultural education. *Journal of Agricultural Education, 37*(3), 67-75.

- Milner, H.R., Flowers, L.A., Moore, E., Moore, J.L., & Flowers, T.A. (2003). Preservice teachers' awareness of multiculturalism and diversity. *The High School Journal*, 87(1), 63-70.
- Pallas, A., Natriello, G. & McDill, E. (1989). The changing nature of the disadvantaged population. *Educational Researcher*, 18 (5). 16-22.
- Perry, P. (2002). *Shades of White: White Kids and Racial Identities in High School*. Durham, NC: Duke University Press.
- Rocca, S. J. & Washburn, S. G. (2008). Preservice agriculture teachers' perceptions of career barriers and support. *Journal of Agricultural Education*, 49(2), 38-49.
- Shavelson, R. J. (1996). *Statistical reasoning for the behavioral sciences, 3rd Edition*. Needham Heights, MA: Allyn & Bacon.
- Sue, D. W. (2001). Multidimensional facets of cultural competence. *The Counseling Psychologist*, 29(6), 790-821. doi: 10.1177/0011000001296002
- Sue, D. W., Arrendondo, P., & McDavis, R. J. (1992). Multicultural competencies and standards: A call to the profession. *Journal of Counseling & Development*, 70(4), 477-486.
- Sue, D.W., Carter, R. T., Casas, J. M., Fouad, N. A., Ivey, A. E., Jensen, M., et al. (1998). *Multicultural counseling competencies: Individual and organizational development*. Thousand Oaks, CA: Sage.
- Sue, D. W. & Sue, D. (2008). *Counseling the culturally diverse: Theory and practice 5th Edition*. Hoboken, NJ: John Wiley and Sons
- Thalheimer, W. & Cook, S. (2002, August). *How to calculate effect sizes from published research articles: A simplified methodology*. Retrieved February 24, 2010 from http://work-learning.com/effect_sizes.htm
- United States Census Bureau (2008). 2008 National *Population Projections* Retrieved March 22, 2010, from <http://www.census.gov/population/www/projections/2008projections.html>
- Villegas, A.M. & Clewell, B.C. (1998). Increasing teacher diversity by tapping the paraprofessional pool. *Theory Into Practice*. 37(2), 121-130.
- Wilkins, A. C. (2008). *Wannabes, Goths, and Christians: The boundaries of sex, style, and status*. Chicago, IL: The University of Chicago Press.
- Woods, M.D. (2004). Cultivating cultural competence in agricultural education through community-based service-learning. *Journal of Agricultural Education*. 45(1), 10-20.

Examining Adult Participation in a Statewide Nonformal Horticultural Program

Robert Strong

Assistant Professor, Texas A&M University

Amy Harder

Assistant Professor, University of Florida

Abstract

Nonformal education is learner-centered and provides knowledge in a practical manner to participants. Adults are inherently self-directed learners with the learning experience. Research is needed to determine the reasons adults participate in nonformal education programs due to little research in existence. Master Gardener (MG) is a nonformal extension horticultural program that includes extensive requirements to earn certification. The purpose of this study was part of a larger study to examine the Mergener Education Participation Scale (M-EPS) to evaluate adult motivations to participate in the Florida MG program. Participants were stratified random sampled and the Tailored Design Method was employed for data collection with a mail survey. The response rate was 86% (N = 530). Through principal component analysis, the reliabilities of the new factors were higher than the reliabilities of the factors associated with the M-EPS. Reliabilities of the new factors were: Other's Perceptions .93, Vary Routine .91, Community Service .90, Socialization .87, Learning .84, and Professional Enhancement .82. Researchers should employ the constructs identified by this study to assess adult motives in nonformal education programs and report the findings to the agricultural education discipline to assist in filling the knowledge gap associated with adult participation in nonformal education programs.

Introduction

The social objectives of education are oriented toward the formation and preservation of a sustainable future (Shohel & Howes, 2010). Tough (1979) said adults are intuitively self-directed learners. Self-directed learners plan, complete, and assess their personal learning experience (Merriam, Baumgartner, & Cafferalla, 2007). Knowles, Holton III, and Swanson (2005) indicated adults have more direction, authority, and responsibility for their learning than youth. Adult learning can be enhanced when researchers and practitioners develop an understanding of the reasons adults participate in the educational program (Merriam, Baumgartner, & Cafferalla, 2007).

According to McCormick (1989), "Agricultural education can be broadened further when nonformal educational programs are included in research" (p. 47). Nonformal education is learner-centered, and focuses on practical skills, knowledge, and application (Etling, 1993). Etling said a nonformal educator should be flexible, and equipped to meet changing student needs. Sixty percent of non-formal education and training is provided by non-formal educational institutions and employers (Boateng, 2009). Kuenzi (2005) indicated nonformal education plays a significant role in the progress of developing countries.

This study was conducted to address the *National Research Agenda's* (Osborne, n.d.) recommendation that research is needed to determine what motivates adults to participate in the agricultural extension programs. Very little substantive research has been conducted on non-formal education participation in the United States (Taylor, 2006). Merriam, Baumgartner, and Cafferalla, (2007) said it is a challenge to evaluate participation in nonformal educational programs. Research is needed to determine why adults participate in nonformal education (Clemons & Vogt, 2004; Kirby, Curran, & Hollett, 2009; Rabušicová & Rabušic, 2006; Yan-Fung & Tsz-Man, 1999).

Master Gardener (MG) is an agricultural nonformal educational extension program offered in many states across the U.S. (Strong & Harder, 2010). Adults undergo extensive procedures in order to earn certification as a Florida MG. In Florida, adults participate in a twelve week course to achieve MG certification. The cost of the twelve week course is approximately \$100 for participants. After earning certified status, adults are required to donate a minimum of 75 volunteer hours back to the MG program. Adults meet this requirement by teaching horticultural information learned from the program to citizens in local communities. More comprehensive research is needed on MG participation to broaden the academic knowledge base of agricultural education, and for practitioners to better understand MGs participation motives in order to improve program delivery (Strong & Harder, 2010).

Theoretical Framework

Houle's (1961) Typology consists of learning classifications that explain adult motives to participate in educational programs. Houle identified the learning, activity, and goal orientations to explain adult motivations in participating in continued learning experiences. Adults may participate for a variety of reasons but understanding the differences is what adult educators should know (Houle, 1961).

Learning-oriented adults participate in educational programs in order to learn new information. Adults in the learning classification believe participating in educational programs is a method to enhance their personal lifestyle. Activity-oriented adults get involved in educational programs in order to meet new people and increase their social circles. Houle (1961) said adults in the activity classification need opportunities for self-reflection due to individual needs are too broad or remedial. Goal-oriented adults participate in educational programs primarily to accomplish specific objectives in their personal or professional life. The objectives adults desire to achieve can be either voluntary on their part or mandated by a business or agency.

Educational programs attract adults for a variety of reasons but each individual participates for their own personal aspiration (Houle, 1961). Adult educators should be able to discern the differences in each motivational orientation in order to best meet the educational needs of participants. Houle said the one trait that all adult students have in common is they are perpetual learners. When educators understand the various motivations of adults, then the journey to teaching and learning will begin (Houle, 1961).

Purpose and Objectives

The purpose of this study was part of a larger study to examine an instrument to evaluate adult motivations to participate in the Florida MG program. Specifically, the objectives were to:

1. Examine the reliability of Mergener's (1979) Education Participation Scale for measuring participants' motivational orientations in the Florida MG program and;
2. Test the unidimensionality of Mergener's (1979) Education Participation Scale when used to measure adults' motivational orientations participating in a nonformal education program.

Methodology

Florida MGs were the population for this study. There were 3,822 MGs in Florida at the time of this study. According to Cochran (1977), a sample size of 362 usable surveys was required for a confidence interval of +/- 5 when $N = 3,822$. Response rates reported in recent literature are utilized to determine the potential response rate for future research involving a mail survey with a similar population (Bartlett, Kotlik, & Higgins, 2001). For mail surveys, 5 to 10 % should be added to the total sample size in order to account for incorrect participant mailing addresses, participants who may have recently passed away, and for questionnaires with incomplete participant responses (Babbie, 2007). The response rate was anticipated to be between 62 and 68% due to response rates in previous research utilizing a mail survey with MGs (Schott, 2001; Schrock, 1999; Sutton, 2006). The sample size was 613 MG participants ($362 \text{ usable surveys} \div 65\% \text{ average response rate} \times 10\% = \text{a sample size of } 613$).

A geographical stratified sampling method was employed for this study. Agresti and Finlay (2009) indicated stratified random sampling separates the population into distinct groups, and then a simple random sample is chosen from each group. Florida Cooperative Extension is divided into five distinct districts: Northwest, Northeast, Central, South Central, and South. The sum of MGs in the five Extension districts (stratum) was $N = 3,822$. Proportional sample allocation was utilized as the sampling technique to select the samples. The sample size in each stratum (district) was selected in proportion to the size of the stratum. The samples were:

1. Sample size in Northwest district = $(586/3,822) 613 = 94$
2. Sample size in Northeast district = $(521/3,822) 613 = 84$
3. Sample size in Central district = $(1,209/3,822) 613 = 194$
4. Sample size in South Central district = $(876/3,822) 613 = 140$
5. Sample size in South district = $(630/3,822) 613 = 101$

A total of 613 MGs were randomly selected for this study. A list of the MGs in each county was provided by the MG coordinator in that county. Counties were purposively selected from each district according to the stratum needed in that district in order for the study to be representative of the total population. Respondents were selected with the use of random number generator in Excel 2007.

The larger study utilized a questionnaire with three sections. For the purposes of this paper, the section of interest was Mergener's (1979) Education Participation Scale. Mergener constructed his version of the Education Participation Scale consisting of 43 items as a derivative of Houle's (1961) adult learning orientation typology. Mergener said the M-EPS was constructed of six factors explaining adult orientations to learning: Competency-related Curiosity (CRC), Interpersonal Relations (IR), Community Service (CS), Escape from Routine (ER), Professional Advancement (PA), and Compliance with External Influence (CEI). The CRC and

CS related to Houle's learning-oriented classification, the IR and ER related to Houle's activity-oriented group, and the PA and CEI related to Houle's goal-oriented classification. Variables on M-EPS were measured on a five-point scale: 1 = *very much influence*, 2 = *much influence*, 3 = *moderate influence*, 4 = *little influence*, 5 = *very little influence* (Mergener, 1979).

The questionnaire was printed as an 8.5" x 11" booklet and mailed to the sampled population. The Tailored Design Method, as outlined by Dillman, Smyth, and Christian (2009), was implemented to increase response rates when utilizing a mail survey. Five hundred thirty-two responses (86.79%) were received. Two responses were pulled from the study for inadequate information and thus, 530 were usable. The results can be generalized to the target population because early and late respondents were compared, and no significant difference existed (Lindner, Murphy, & Briers, 2001).

The study's first objective was to examine the reliability of Mergener's (1979) Education Participation Scale on participants of a nonformal education program. Reliability is the consistency of a social sciences instrument (Agresti & Finlay, 2009). Ary et al. (2006) said "internal consistency determines whether all items in the instrument are measuring the same thing" (p. 261). Cronbach's alpha is the most widely used measure of reliability on attitude scales (Agresti & Finlay). The reliability of the M-EPS in Mergener's research was .90.

The second objective sought to test the unidimensionality of Mergener's (1979) Education Participation Scale. The M-EPS had not been previously used to discover what motivates adults to participate in Master Gardener or other nonformal educational programs. The researchers utilized the M-EPS due to the instrument's derived association with Houle's (1961) Typology and the academic and practical need to develop an understanding of adult motives to participate in Florida MG.

Principal component analysis (PCA) with orthogonal varimax rotation and the Kaiser criterion was utilized to test the unidimensionality of the M-EPS. Agresti and Finlay (2009) identified PCA as an approach to identify patterns in data in order to emphasize similarities and differences in the dataset. Costello and Osborne (2005) said orthogonal varimax rotation is the most commonly used extraction method to refine a study's data structure into factor loadings. The loading of a variable on a factor is referred to as the correlation of the variable with the factor (Agresti & Finlay). Factor loadings range from .40 (low) to .70 (moderate) in social science research (Costello & Osborne, 2005). The Kaiser criterion produces all items with eigenvalues greater than one (Costello & Osborne, 2005).

Findings

The study's first objective was to examine the reliability of Mergener's (1979) Education Participation Scale on participants' motivational orientations in a nonformal education program. The internal consistency of items in a scale are measured by Cronbach's alpha coefficients (Cronbach, 1951). These coefficients are utilized to indicate each item's reliability (Ary et al., 2006). The reliability of the M-EPS was calculated *ex post facto* at .93. Reliability levels for each of the factors in the M-EPS were calculated *ex post facto* (see Table 1).

Table 1

Reliability Levels of Factors in the Mergener's (1979) Education Participation Scale

Internal Scale	α Levels (<i>N</i> = 530)
Professional Advancement	.70
Escape from Routine	.81
Competence related Curiosity	.76
Community Service	.84
Interpersonal Relations	.77
External Influence	.79

Note: Reliability levels $\geq .80$ were considered acceptable (Cronbach, 1951).

The study's second objective was to test the unidimensionality of Mergener's (1979) Education Participation Scale. Initially, the factorability of the 41 M-EPS items was examined. Responses to the 41 items on the M-EPS were factor analyzed by the method of principal component analysis and then rotated to achieve orthogonal and oblique structure according to the varimax criteria of Babbie (2007). Factor loadings of .43 or more were considered acceptable (see Table 2).

Certain items loaded on separate factors than Mergener (1979) reported in the M-EPS. To account for the new and altered factors, the new factors were labeled with different names. Competence related Curiosity became 'Learning', Interpersonal Relations became 'Socialization', Escape from Routine became 'Vary Routine', and Professional Development and External Influence were combined to form 'Professional Enhancement.' Community Service remained Community Service. A new factor, called Other's Perceptions, was formed.

Six items were dropped from the analysis due to the inability of forming the items into two separate factors. The items removed were "To Comply with Recommendations from Someone Else", "To Keep Up with Others", "To Supplement a Previous Narrow Education", "To Clarify What I Want to Be Doing 5 Years from Now", "To Overcome the Frustrations of Day to Day Gardening", and "To Acquire Knowledge that Will Help with Other Courses".

Six items loaded on the Learning factor and items ranged from .82 to .45 (see Table 2). Five items loaded on the Community Service factor ranging from .78 to .43 and five items loaded on the Socialization factor ranging from .76 to .56. Seven items loaded on the Vary Routine factor and items ranged from .79 to .50. Eight items loaded on the Professional Enhancement factor and items ranged from .80 to .45. Four items loaded on the Other's Perceptions factor and items ranged from .65 to .51. Items loading on two separate factors ranged from .66 to .42.

Table 2

Partition of Variance among Factors in the M-EPS (N = 530)

<i>Factors</i>	<i>Factor Loadings</i>
<i>Competence related Curiosity (Learning)</i>	
To Feed an Appetite for Knowledge	.82
To Satisfy an Inquiring Mind	.81

To Satisfy Intellectual Curiosity	.75
To Seek Knowledge for its Own Sake	.64
To Obtain Practical Benefit	.46
To Respond to the Fact that I am Surrounded by People Who Continue to Learn	.45
<i>Community Service</i>	
To Improve My Ability to Serve Mankind	.78
To Prepare for Community Service	.76
To Be a More Effective Citizen	.74
To Improve My Community Work	.70
To Comply with the Ethics of the Horticulture Industry	.43
<i>Interpersonal Relations (Socialization)</i>	
To Participate in Group Activities	.76
To Become Acquainted with Congenial People	.74
To Share a Common Interest with Someone Else	.69
To Fulfill a Need for Personal Associations	.66
To Improve Social Relationships	.56
<i>Escape from Routine (Vary Routine)</i>	
To Get a Break from Routine of Home or Work	.79
To Gain Relief from Boredom	.70
To Provide a Contrast to the Rest of My Life	.66
To Have a Few Hours Away from Responsibilities	.62
To Stop Myself from Becoming Stagnant	.55
To Provide Contrast to My Previous Education	.51
To Escape the Intellectual Narrowness of My Occupation	.50
<i>Professional Development & External Influence (Professional Enhancement)</i>	
To Give Me Higher Status on the Job	.80
To Secure Professional Advancement	.78
To Fulfill My Professional Obligation	.69
To Fulfill Requirements of a Government Agency	.64
To Help Me Earn a Degree, Diploma or Certificate	.62
To Maintain or Improve My Social Position	.61
To Carry Out the Recommendations from Some Authority	.58
To Comply with My Employer's Policy	.45
<i>Other's Perceptions</i>	
To Comply with the Fact that People with Status and Prestige Attend Adult Education Classes	.65
To Take Part in an Activity which is Customary in the Circles in which I Move	.59
To Be Accepted by Others	.57
To Gain Insight into Human Relationships	.51
<i>Items Loaded into a Separate Construct</i>	
To Comply with Recommendations from Someone Else	.66
To Keep Up with Others	.60
To Supplement a Previous Narrow Education	.54
<i>Items Loaded into a Separate Construct</i>	
To Clarify What I Want to Be Doing 5 Years from Now	.58
To Overcome the Frustrations of Day to Day Gardening	.51
To Acquire Knowledge that Will Help with Other Courses	.42

Note: Factors with a loading of .43 were considered acceptable (Babbie, 2007).

Conclusions

The first objective of the study was to examine the reliability of Mergener's (1979) Education Participation Scale on participant's motivational orientations in the Florida MG program. In this study, Cronbach's (1951) alpha of the M-EPS was .93. The M-EPS is a reliable instrument in assessing adult motivations for participating in MG programs. However, Professional Advancement, Competence related Curiosity, Interpersonal Relations, and External Influence had suspect reliability levels (Cronbach, 1951).

The study's second objective was to test the unidimensionality of Mergener's (1979) Education Participation Scale on adults' motivational orientations for participating in a nonformal education program. The researchers employed factor loadings produced by principal component analysis to examine the M-EPS. Previous items associated with factors identified by Mergener, loaded on separate factors in this study. The conclusion is that the factors for the M-EPS are not applicable when used with Florida MGs.

The reliabilities of the new factors were higher than the reliabilities of the factors associated with the M-EPS. Reliabilities of the new factors were: Other's Perceptions .93, Vary Routine .91, Community Service .90, Socialization .87, Learning .84, and Professional Advancement .82. The reliability of the updated instrument was calculated *ex post facto* at .96.

A conceptual framework represents factor loadings of factors on Mergener's (1979) Education Participation Scale related to Houle's (1961) Typology for formal adult education programs and loadings of factors on new instrument for the Florida MG nonformal adult educational program to further explain Houle's Typology (see Figure 1). Learning, Community Service, Socialization, Vary Routine, Professional Enhancement, and Other's Perceptions were the new factors produced to further explain Houle's Typology on motivational orientations of adults participating in nonformal educational programs. Unrelated items loading on the two separate factors were eliminated from the framework.

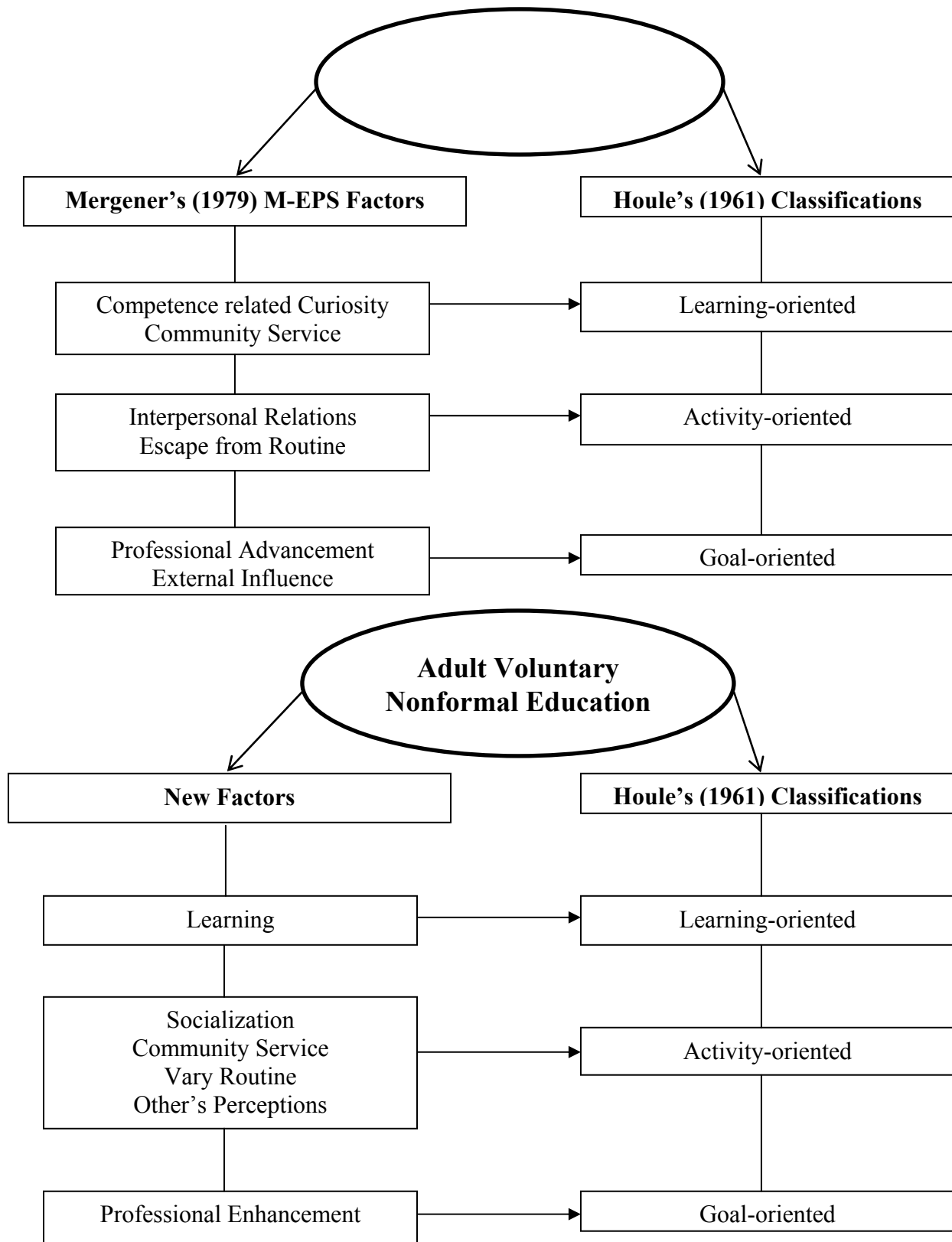

Figure 1. A conceptual framework of M-EPS Constructs Realigned from Principal Component Analysis Resulting in an Updated Instrument to Further Explain Houle's (1961) Typology

Implications

Houle (1961) said adults participate in continued learning for a variety of reasons. Mergener (1979) designed the M-EPS with constructs based upon Houle's learning classifications Typology. The constructs produced from testing the unidimensionality of the M-EPS in this study serve to further knowledge on Houle's original findings as well by producing the constructs identified by this study.

The constructs identified by this study modified constructs fit Houle's (1961) Typology. The modified Learning construct related to Houle's (1961) learning-oriented classification. This information should inform MG coordinators that adults in this classification are devoted to learning and participate in the educational program due to their constant quest of learning (Houle).

The modified constructs of Socialization, Community Service, Vary Routine and Other's Perceptions from the constructs identified by this study related to Houle's (1961) activity-oriented classification. These findings should assist practitioners in developing an understanding of adults in this classification participates in MG for diverse reasons associated with social contact (Houle). Activity-oriented adults mainly participate in educational programs to broaden their social network (Houle).

The modified construct of Professional Enhancement relates to Houle's (1961) goal-oriented classification. These results should inform MG coordinators that adults in this classification would participate in MG in order to meet a professional objective or a goal someone has recommended to accomplish (Houle). The differences in adults are the focal point of Houle's Typology.

The constructs identified by this study can be utilized to assess adult motivations to participate in nonformal education. In this study, the factors may have loaded differently due to dissimilar populations. Mergener's (1979) study included pharmacy students participating in a continued learning experience mandated by the profession. Adults participating in MG as volunteer educators may have caused items to load on separate constructs in this study. The disparity in factor loadings may not solely be due to the population but could include the type of educational program. The difference of factor loadings could be explained by adults participating in mandated formal educational programs versus adults volunteering in a nonformal educational program.

Recommendations

Researchers should utilize the constructs identified in this study to examine Master Gardener's motivational orientations for MG participation. The inclusion of the constructs may provide researchers and practitioners more insight on adult motivations in MG. The constructs identified by this study should be tested further in order to ascertain if identical items load on similar constructs as this study.

MG participants should not be the only population researched with the constructs identified by this study. Diverse adult nonformal education populations should be studied with the constructs identified by this study due to the potential of gaining insight on adult motivations for participating in nonformal educational programs. There are other examples of 'Master'

nonformal education programs offered by Extension: Master Equine Manager, Master Naturalist, Master Goat and Sheep Producer, Master Logger, Master Beef Producer, etc. The constructs identified by this study should be utilized to research adult motivations to participate in those nonformal educational programs. The findings should be shared with agricultural education academics and extension practitioners.

Adults participate in a variety of nonformal agricultural leadership educational programs. Researchers should employ the constructs identified by this study to assess adult motives in those programs and report the findings to the agricultural education discipline. This information would assist agricultural leadership faculty, coordinators of statewide agricultural leadership programs and educators of agricultural leadership programs on local levels insights on adult motivations to participate in continued agricultural leadership learning experiences. This information would broaden the knowledge base of agricultural education too.

The constructs identified by this study provided insight on motivational orientations of adults participating in Florida MG. Given the time and resource adults provide the Florida MG program, an essential need exists for local MG coordinators to learn adults' motivations for participating in the program. Continuing to conduct research with Master Gardeners will help Extension develop an understanding of volunteer needs and how to best utilize MGs to educate the public and meet organizational objectives.

References

- Agresti, A., & Finlay, B. (2009). *Statistical methods for the social sciences* (4th ed.). Upper Saddle River, NJ: Prentice Hall.
- Ary, D., Jacobs, L. C., Razavieh, A., & Sorenson, C. (2006). *Introduction to research in education* (7th ed.). Orlando, FL: Harcourt Brace & Company.
- Babbie, E. (2007). *Survey research methods* (11th ed.). Belmont, CA: Wadsworth.
- Bartlett II, J. E., Kotrlik, J. W., & Higgins, C. C. (2001). Organizational research: Determining appropriate sample size in survey research. *Information Technology, Learning and Performance Journal*, 19(1), 43-50.
- Boateng, S. W. (2009). Significant country differences in adult learning. *Statistics in Focus*, 44, 1-11.
- Clemons A., & Vogt, C. (2004). Theorizing, restructuring and rethinking nonformal education in east and west African communities. *Current Issues in Comparative Education*, 6(2), 88-99.
- Cochran, W. G. (1977). *Sampling techniques* (3rd ed.). New York, NY: John Wiley & Sons.
- Costello, A. B., & Osborne, J. W. (2005). Best practices in Exploratory Factor Analysis: Four recommendations for getting the most from your analysis. *Practical Assessment Research and Evaluation*, 10(7), 1-9.

- Cronbach, L. J. (1951). Coefficient alpha and the internal structure of tests. *Psychometrika*, 16, 297-334.
- Dillman, D. A., Smyth, J. D., & Christian, L. M. (2009). *Internet, mail and mixed-mode surveys: The Tailored Design Method* (3rd ed.). New York, NY: John Wiley & Sons.
- Etling, A. (1993). What is nonformal education? *Journal of Agricultural Education*, 34(4), 72-76.
- Houle, C. O. (1961). *The inquiring mind* (2nd ed.). Madison: University of Wisconsin Press & Norman: Oklahoma Research Center for Continuing Professional and Higher Education.
- Kirby, D., Curran, V., & Hollett, A. (2009). Non-formal adult learning programs at Canadian Post-Secondary Institutions: Trends, Issues, and Practices. *Canadian Journal of University Continuing Education*, 35(2), 63-86.
- Knowles, M. S., Holton III, E. F., & Swanson, R. A. (2005). *The adult learner: The definitive classic in adult education and human resource development* (6th ed.). Burlington, MA; Elsevier.
- Kuenzi, M. (2005). Non-formal education and community development in Senegal. *Community Development Journal*, 41(2), 210-222.
- Lindner, J. R., Murphy, T. H., & Briers, G. E. (2001). Handling nonresponse error in social science research. *Journal of Agricultural Education*, 42(4), 43-53.
- McCormick, F. G. (1989). What is in a name? *Journal of Agricultural Education*, 30(1), 44-50.
- Mergener, M. A. (1979). The motivational orientations of pharmacists toward continuing education. *Dissertation Abstracts International*, 39(08), 3775B. (UMI No. 7820638)
- Merriam, S. B., Cafferalla, R. S., & Baumgartner, L. M. (2007). *Learning in adulthood: A comprehensive guide* (3rd ed.). San Francisco, CA: Jossey-Bass.
- Osborne, E. W. (Ed.) (n.d.). *National research agenda: Agricultural education and communication, 2007-2010*. Gainesville, FL: University of Florida, Department of Agricultural Education and Communication.
- Rabušicová, M., & Rabušic, L. (2006). Adult education in the Czech Republic – Who participates and why. *Czech Sociological Review*, 42(6), 1195-1218.
- Schott, N. J. (2001). Volunteer motivation and satisfaction associated with the University of Illinois Extension Master Gardener program. *Dissertation Abstracts International*, 61(10), 3847A. (UMI No. 9990131)

- Schrock, D. S. (1999). **A functional approach to understanding and assessing the motivation and retention of university extension Master Gardener volunteers.** *Dissertation Abstracts International*, 59(12), 6508B. (UMI No. 9913378)
- Shohel, M. M. C., & Howes, A. J. (2010). Models of education for sustainable development and nonformal education: A Bangladeshi perspective. *Journal of Education for Sustainable Development* (In-Press).
- Strong, R., & Harder, A. (2010). Master Gardeners' teaching efficacy and demographic characteristics as volunteer educators for Cooperative Extension. *Journal of Southern Agricultural Research*, 60, 14-24.
- Sutton, E. A. (2006). An evaluation of the Master Gardener Program in Arkansas. *Dissertations Abstracts International*, 44(05). (UMI. 15456).
- Taylor, E. W. (2006). Making meaning of local nonformal education: Practitioner's perspective. *Adult Education Quarterly*, 56(4), 291-307.
- Tough, A. (1979). *The adult's learning projects: A fresh approach to theory and practice in adult learning* (2nd ed.). Toronto, Ontario: Institute for Studies in Education.
- Yan-Fung, M., & Tsz-Man, K. (1999). Social-influence factors and motivations of participation in adult higher education. *Education Journal*, 27(2), 83-101.

Refocusing Evaluation Efforts: Evaluating Extension Programs for Use Can Enhance Accountability Efforts

Alexa J. Lamm

University of Florida
310 Rolfs Hall
PO Box 110540
Gainesville, FL 32611-0540
Ph: 352-392-0502 ext. 238
FAX: 352-392-9585
alamm@ufl.edu

Glenn D. Israel

University of Florida

Amy Harder

University of Florida

Abstract

Extension has enhanced the lives of U.S. citizens through adult education in a myriad of ways. However, as budgets get tighter, accountability becomes increasingly more important. Over the years, Extension has reported low level impacts rather than the long-term successes that those working within the system know are occurring. Without enhanced evaluation-driven environments, Extension systems will continue to inadequately report programmatic successes, resulting in a lower perceived public value of Extension programs. The use of evaluation can create an atmosphere which encourages organizational thinking resulting in the types of accountability reports which are adequate for decision making. This study examined how extension professionals' perceptions of evaluation use related to their evaluation behaviors. The findings suggest a substantial percentage of extension professionals are doing just enough evaluation to complete mandatory reports. It also showed that extension professionals who valued their own personal use, but not necessarily organizational use of their evaluations, were more likely to conduct in-depth evaluations. Recommendations for enhancing evaluation driven work environments include clearer communication from administration demonstrating the value of evaluation beyond the role it plays in accountability and working directly with extension professionals to promote evaluation-oriented conversations rather than just delivering state-led in-service trainings.

Introduction

Extension is extremely diverse and widely distributed, offering the largest adult education system in the United States (Franz & Townson, 2008). It encompasses nearly 3,150 county extension offices, 105 land-grant colleges and universities, and the federal government through USDA's National Institute of Food and Agriculture (NIFA) (Cooperative State Research, Education, and Extension Service, n.d.). Extension professionals' work is extremely valuable due to its ability to enhance the lives of U.S. residents by "extending" the reach of the land grant

university through research based education on topics including agriculture, community development, youth development, natural resources, nutrition, financial management, and horticulture (Rasmussen, 1989).

However, due to its size, development, and growth over the past hundred years, Extension faces some unique challenges when held accountable for proving its worth to the public.

Accountability is a “state of, or process for, holding someone to account to someone else for something – that is, being required to justify or explain what has been done” (Rogers, 2003, p. 2). Accountability is typically used as a justification for conducting evaluations. However, accountability driven evaluations place an emphasis on looking back and judging programs by placing blame or praise and leave little room for learning (Patton, 2008). Cronbach (2000) believed evaluation is better used to gain an understanding of processes and outcomes to guide future activities in a positive way. Accountability is based on the premise that funders will use the information in evaluation reports to guide future funding and policy decisions. The information they gather is, however, rarely adequate for conducting these types of appraisals. In essence “accountability systems serve the purpose of providing an account of how things are going but not enough information to inform decisions or solve problems” (Patton, 2008, p. 121).

Evaluation Use

Extension’s future is largely dependent upon its ability to adapt and learn from its employees and environment (Burke, 2008). The use of evaluation can create an atmosphere which encourages organizational thinking and learning resulting in the types of accountability reports which are adequate for decision making. “Learning means the willingness to go slowly, to try things out, and to collect information about the effects of actions, including the crucial but not always welcome information that the action is not working” (Meadows, Randers, & Meadows, 2004, p. 7).

A culture supporting evaluation use within most state Extension systems has been limited (Radhakrishna & Martin, 1999) despite recognition of the importance of evaluation as an extension employee competency (Harder, Place, & Scheer, 2010). Due to an initial push to measure short-term changes in the 1980’s, the majority of Extension professionals currently utilize posttests given at the conclusion of their educational activities to assess the level of success (Franz & Townson, 2008). While low level reactions and some knowledge and skills gained are accounted for with this method, intermediate and long-term outcomes recording actual behavior changes along with social, economic and environmental impacts of Extension programs are often lacking. Without enhanced evaluation-driven environments, the state and federal Extension systems will continue to inadequately report programmatic successes, resulting in a lower perceived public value of Extension programs. Since assessing the effectiveness of educational programs in agricultural and life sciences is part of the National Research Agenda: Agricultural Education and Communication, 2007-2010 (Osborne, 2007), a study exploring the ways in which extension professionals’ evaluation behaviors are related to personal and organizational evaluation use can yield valuable data providing direction for future practice.

Theoretical Framework

The theoretical framework for this study was based on Patton's (2008) theory of utilization focused evaluation. Utilization focused evaluators work with intended users "to determine priority uses early in the evaluation process" (Patton, 2008, p. 98). The chosen intended use then informs the design of the evaluation process including data collection, timing, data analysis, and reporting. Through prior planning, this increases the chance the evaluation will result in the desired impact and be used as intended. It is important to recognize the different contexts of which the term use can have within the practice of evaluation. Program planners often think they are conducting utilization focused evaluation, when in fact they are organizing evaluations for other purposes under the guise of "use." Patton (2008) recognized there are many distinctions in how evaluators, program coordinators, and administrators refer to use. These distinctions included (1) direct intended uses, (2) longer term uses, (3) primarily political uses, (4) misuses, (5) non-uses and (5) unintended effects (Patton, 2008). This study will focus on the direct intended uses of evaluation in the context of Extension programming.

Direct intended uses include instrumental use, conceptual use, and process use. Instrumental use of evaluations includes using findings to directly inform decisions and often contribute to problem solving (Patton, 2008). Instrumental use links the results to an action essentially becoming an instrument of action. An example of instrumental evaluation use would be a basic assessment of an Extension program or tool. In Arkansas, a farm pond management website was evaluated over a four year period (Neal, 2010). Responses to an online survey were collected, identifying that the web site was stakeholders' preferred method of communication. As a result, the other more traditional Extension media used for communication with these stakeholders was discontinued (Neal, 2010). Another example of instrumental use is an evaluation conducted by Menalled, Grimberg, and Jones (2009) assessing agricultural professionals' needs, knowledge, and interests as they related to sustainable farming. The information collected was directly applied to the creation of a distance education program in sustainable agriculture (Menalled et al., 2009).

Conceptual use informs thinking about a program or policy. The results of conceptual use evaluation are used to assist key people in understanding a concept but no action or decision can be directly attributed to the results (Patton, 2008). While this type of evaluation can contribute to offering future conceptual insight it is not specific to a certain time or place like instrumental use evaluation. Kaplan, Liu, and Radhakrishna (2003) conducted a needs assessment study in order to plan and develop a statewide intergenerational extension program. Kaplan et al. (2003) collected data noting extension professionals' preferences regarding program content and delivery format. The results were used to make key decisions about the direction curriculum would take and future program delivery strategies but were not specific to one place in time. Culp and Kohlhagen (2004) conducted an evaluative study examining extension agents' level of competence when working with volunteers. They then used this information to plan and develop volunteer administration professional development opportunities that would increase agents' knowledge and/or performance in the future.

According to Patton (2008), "Process use refers to cognitive, behavioral, program, and organizational changes resulting ... from engagement in evaluation process and learning to think evaluatively" (p. 108). Process use is essentially learning from the evaluation process itself and

engaging in decision-making based on the process and not the end result. Rather than being results oriented, the evaluation process can begin to become a tool for making programmatic decisions, as it helps program planners further refine and define exactly what they want as an intended outcome. Cummings and Boleman (2006) worked to identify issues the Texas extension system needed to be addressing during the Texas Community Futures Forum by engaging stakeholders to gain their input. Through this process not only did they identify issues of need, but they were also able to engage all levels of extension faculty in conversations to deal with common issues, develop issue responses, and identify resources needed to address these needs (Cummings & Boleman, 2006). Therefore, not only did the evaluation results assist in identifying needs, but the evaluation process facilitated open communication that would otherwise not have occurred.

An examination of the literature has revealed that a focus on evaluation use has the ability to enhance programmatic evaluation behaviors thereby resulting in more appropriate measures for accountability purposes. Through a review of the theory of user focused evaluation, it has been established that individual and organizational use can be categorized into three areas: instrumental, conceptual, and process evaluation use (Patton, 2008). By understanding how use is perceived and related to evaluation behavior, research based recommendations on how to enhance evaluation behaviors in the future can be made (Patton).

Purpose & Research Questions

The purpose of this study was to examine how extension professionals' perception of evaluation use relates to their evaluation behaviors. The research questions guiding this study were:

1. How are extension professionals evaluating their programs?
2. What are extension professionals' perceptions regarding the use of evaluation?
3. Do extension professionals' perceptions regarding the use of evaluation have a relationship with the level at which they conduct evaluation?

Methods

The study presented here is part of a larger study and is descriptive and correlational. A census of the 128 extension agents and county directors working directly with customers in their respective counties, all within the same state, was conducted. The study was limited to this state because the Extension administration is currently stressing the importance of evaluation for accountability within the system due to budgetary issues.

The target population's access to the Internet and use of e-mail as a communication tool enabled the use of an online survey instrument (Dillman, Smyth, & Christian, 2008). Due to a lack of previous research on the topic, an instrument measuring the variables of interest was not available, therefore the researcher created an organizational evaluation instrument. This instrument asked participants to provide data related to their evaluation behaviors and perceptions regarding organizational factors associated with evaluation including their perceptions regarding the use of evaluation results. The instrument was reviewed by an expert panel with expertise in Extension and the practice of evaluation for content, face validity, and survey design. The panel of experts represented four universities including the University of Florida, North Carolina State University, Purdue University, and Oklahoma State University.

Four sections of the survey instrument were germane to the findings in this article: personal evaluation behaviors, personal perceptions regarding evaluation use, perceptions of organizational evaluation use, and demographics. Reliability was calculated *ex post facto* on the two constructs specific to this study. The personal perception regarding evaluation use construct had a Cronbach's $\alpha = .82$. The perceptions of organizational evaluation use construct had a Cronbach's $\alpha = .83$.

To measure their evaluation behaviors, participants were asked to report on how they evaluated their "best" or "most important" program. Participants were asked to respond by marking whether or not they had engaged in 27 specific data collection or data analysis/reporting methods during the past year. If they had engaged in the specific method they were given a point. The responses were summed to create an overall behavior score which could range from 0 to 27.

Participants were then asked to assess their personal perceptions regarding evaluation use by rating a set of six questions related to their personal use of the evaluation process on a Likert-type scale. The scale ranged from 1 – *Not at all true for me*, 2 – *Slightly true for me*, 3 – *Somewhat true for me*, 4 – *Mostly true for me*, 5 – *Completely true for me*. Three of these six items referred to the instrumental use of evaluation while the other three referred to the conceptual use of evaluation.

Next, participants were asked to rate seven statements related to their perceptions of organizational evaluation use on a Likert-type scale. The scale ranged from 1 – *Strongly Disagree*, 2 – *Disagree*, 3 – *Neutral*, 4 – *Agree*, 5 – *Strongly agree*. Six of these seven items referred to instrumental use of evaluation, while one referred to the process use of evaluation. Finally, participants were asked to identify their gender, race/ethnicity, educational level, and primary program area.

Participants were contacted via e-mail using Dillman et al.'s (2008) Tailored Design Method. All of the original 128 e-mail addresses were valid. A response rate of 84% ($N = 105$) was obtained. There were 11 responses removed due to missing or incomplete data so the useable response rate was 73.4%. There were no significant differences between respondents and non-respondents demographic characteristics; therefore the results of the study can be generalized to the target population.

The general demographics collected in the survey are displayed in Table 1. Descriptive analysis of the demographic data showed that there were 52 female (53.2%) and 42 male (43.6%) respondents. The large majority (90.4%, $n = 85$) of respondents were Caucasian/White (Non-Hispanic) with Hispanics representing 9.6% ($n = 9$). African American, Native American, and Other categories were represented minimally. The majority of respondents (74.5%, $n = 70$) had obtained a Master's degree while 14.9% ($n = 14$) had a Bachelor's degree.

All program areas were represented with 36.2% ($n = 34$) of respondents focusing on 4-H Youth Development, 22.3% ($n = 21$) on Family and Consumer Sciences, 17.0% ($n = 16$) on Agriculture, and 9.6% ($n = 9$) on Horticulture. The remaining 10.7% ($n = 10$) of participants represented Community Development and Natural Resources specializations.

Table 1

Demographics of Respondents

Characteristic	<i>n</i>	<i>%</i>
<u>Gender</u>		
Female	52	53.2
Male	42	43.6
<u>Race/Ethnicity</u>		
African American	1	1.1
Asian	0	.0
Caucasian/White (Non-Hispanic)	85	90.4
Hispanic	9	9.6
Other	3	3.2
<u>Education Level</u>		
Associate's Degree	2	2.1
Bachelor's Degree	14	14.9
Master's Degree	70	74.5
Ph.D.	4	4.3
<u>Program Area</u>		
4-H Youth Development	34	36.2
Agriculture	16	17.0
Community Development	6	6.4
Family and Consumer Sciences	21	22.3
Horticulture	9	9.6
Natural Resources	4	4.3

Data Analysis

The first two objectives were addressed using descriptive statistics. Responses were coded for computer analysis using SPSS. Relationships between extension professionals' evaluation behaviors and their perceptions regarding the use of evaluation were described by calculating Pearson's product-moment correlation coefficient using Davis' (1971) convention. Magnitude of the relationship is noted by Davis as $.01 \geq r \geq .09$ = Negligible, $.10 \geq r \geq .29$ = Low, $.30 \geq r \geq .49$ = Moderate, $.50 \geq r \geq .69$ = Substantial, $r \geq .70$ = Very Strong. A level of significance of .05 was established *a priori*.

Results

Evaluation Behaviors

Participants were asked to report on how they evaluated their "best" or "most important" program by marking whether or not they had engaged in 27 specific data collection or data analysis methods during the past year (see Table 2). The responses were summed to create an evaluation behavior score. Overall evaluation behavior scores ranged from zero to 27 ($M = 10.53$, $SD = 6.39$).

When data collection methods were reviewed the majority of participants kept program participation records ($n = 70$, 74.5%) and used post tests to evaluate specific activities ($n = 64$,

68.1%). Approximately half of the participants used post tests to evaluate their entire program ($n = 51, 54.3\%$), tracked their participants' gender ($n = 50, 53.2\%$), and used interviews to evaluate specific activities ($n = 47, 50.0\%$). Very few used a comparison group as a control when evaluating ($n = 5, 5.3\%$) or used tests to evaluate social, economic, or environmental (SEE) condition changes ($n = 17, 18.1\%$). Examining data analysis/reporting methods revealed the majority of participants are reporting the number of customers attending a program ($n = 72, 76.6\%$), creating summaries of written accounts ($n = 55, 58.5\%$), and reporting means and percentages ($n = 50, 53.2\%$). Very few used any type of inferential statistic ($n = 2, 2.1\%$), compared groups ($n = 12, 12.8\%$), or reported standard deviations ($n = 13, 13.8\%$).

Table 2
Participants Evaluation Behaviors

Behavior Items	<i>n</i>	<i>%</i>
<u>Data Collection Methods</u>		
Keep program participation records	70	74.5
Post test to evaluate activities	64	68.1
Post test to evaluate entire program	51	54.3
Track participants' gender	50	53.2
Interviews to evaluate activities	47	50.0
Participant written accounts	43	45.7
Interviews to evaluate entire program	43	45.7
Pre/post test to evaluate activities	42	44.7
Collect artifacts	39	41.5
Interview to evaluate behavior change	39	41.5
Track participants' race/ethnicity	38	40.4
Pre/post test to evaluate entire program	37	39.4
Test to evaluate behavior change	29	30.9
Interviews to evaluate SEE changes	22	23.4
Test to evaluate SEE changes	17	18.1
Comparison group used as a control	5	5.3
<u>Data Analysis/Reporting Methods</u>		
Report actual numbers	72	76.6
Summary of written accounts	55	58.5
Report means or percentages	50	53.2
Summary of artifacts collected	44	46.8
Summary of interview results	43	45.7
Examine change over time	25	26.6
Comparing content of interviews for similarities and differences	19	20.2
Member checking interview results	19	20.2
Report standard deviations	13	13.8
Compare groups	12	12.8
Advanced inferential statistics	2	2.1

Perceptions of Evaluation Use

Table 3 displays participants' personal perceptions regarding the use of evaluation. Using a five-point scale (1 = *Not at all true for me*, 5 = *Completely true for me*), participants felt evaluation

was a critical tool for improving extension programs ($M = 4.30$, $SD = 0.84$), that they identify the needs and interests of their stakeholders prior to developing programs ($M = 4.01$, $SD = 0.85$), that they think it is important their evaluation results can be used by others in their state system ($M = 4.01$, $SD = 0.82$), and that they use their evaluation results to make decisions about their programs ($M = 4.00$, $SD = 0.90$). They were not as sure their evaluations served the information needs of their community stakeholders ($M = 3.45$, $SD = .91$) and that they report their evaluation procedures and results to their community stakeholders ($M = 3.61$, $SD = 0.94$). Responses to all six perceptions of personal evaluation use items were summed and averaged to create an overall perception of personal evaluation use score ($M = 3.90$, $SD = .63$) that tended to be positive.

Table 3
Participant's Personal Perceptions Regarding Evaluation Use

Evaluation Use Items	Evaluation Use Category	<i>N</i>	<i>M</i>	<i>SD</i>
I feel evaluation is a critical tool for improving extension programs	Instrumental	94	4.30	.84
I identify the needs and interests of my stakeholders prior to developing programs	Conceptual	94	4.01	.85
I think it is important my evaluation results can be used by others within my state extension system	Instrumental	94	4.01	.82
I use evaluation results to make decisions about my programs	Instrumental	94	4.00	.90
I report evaluation procedures and result to my community stakeholders	Conceptual	94	3.61	.94
My evaluations serve the information needs of my community stakeholders	Conceptual	94	3.45	.91

Note: Scale: 1 = *Not at all true for me*, 2 = *Slightly true for me*, 3 = *Somewhat true for me*, 4 = *Mostly true for me*, 5 = *Completely true for me*

Table 4 displays participants' perceptions of organizational evaluation use using a five-point scale (1 - *Strongly Disagree*, 5 - *Strongly Agree*). They were in slight agreement that their county directors were interested in using their evaluation results ($M = 3.59$, $SD = 1.04$) and also slightly agreed that there is a moderate interest in using data to make decisions in their extension offices ($M = 3.52$, $SD = .92$). Participants did not report a high level of agreement when asked to rate the level at which their county director ($M = 3.05$, $SD = 1.12$) or regional director ($M = 3.07$, $SD = 1.02$) communicates about how evaluation results will be used. Responses to all seven perceptions of organizational evaluation use items were summed and averaged to create an overall perception of organizational evaluation use score ($M = 3.22$, $SD = .74$) which was slightly higher than neutral.

Table 4
Participant's Perceptions of Organizational Evaluation Use

Evaluation Use Items	Evaluation Use Category	<i>N</i>	<i>M</i>	<i>SD</i>
My county director is interested in using my evaluation results*	Instrumental	44	3.59	1.04

There is a strong interest in using data to make decisions in my extension office	Instrumental	90	3.52	.92
My regional director is interested in using my evaluation results*	Instrumental	81	3.49	.98
Extension professionals discuss evaluation approaches, challenges, and use in my extension office	Process	90	3.22	.97
The state extension director seeks evaluation information when making decisions	Instrumental	89	3.22	.84
My regional director clearly communicates how evaluation results will be used*	Instrumental	81	3.07	1.02
My county director clearly communicates how evaluation results will be used*	Instrumental	44	3.05	1.12

Note: Scale: 1 = *Strongly Disagree*, 2 = *Disagree*, 3 = *Neutral*, 4 = *Agree*, 5 = *Strongly Agree*

*Participants not reporting to a county or regional director did not respond to these items.

Relationships between Evaluation Behaviors and Perceptions of Evaluation Use

The personal perceptions index was moderately correlated with evaluation behavior, while the organizational perceptions index had only a low correlation with evaluation behavior (Table 5). All but one of the personal perceptions of evaluation use items were moderately correlated with the participants' evaluation behaviors. Whether or not the participants' evaluations served the information needs of their community stakeholders ($R = .43$) had the highest correlation among these items. Of the organizational perception of evaluation use items only one, if extension professionals discuss evaluation approaches, challenges, and use in their extension office ($R = .36$), had a moderate correlation to their evaluation behavior. Extension professionals' perception regarding whether or not the state extension director seeks evaluation information when making decisions had a negligible negative correlation to evaluation behavior ($R = -.04$).

Table 5

Correlations between Evaluation Behaviors and Perceptions of Evaluation Use

Perceptions of Evaluation Use	Evaluation behavior	
	<i>R</i>	Magnitude
Personal Perceptions	.47	Moderate
My evaluations serve the information needs of my community stakeholders	.43	Moderate
I report evaluation procedures and result to my community stakeholders	.36	Moderate
I use evaluation results to make decisions about my programs	.35	Moderate
I identify the needs and interests of my stakeholders prior to developing programs	.32	Moderate
I think it is important my evaluation results can be used by others within my state extension system	.30	Moderate
I feel evaluation is a critical tool for improving extension programs	.28	Low
Organizational Perceptions	.27	Low
Extension professionals discuss evaluation approaches,	.36	Moderate

challenges, and use in my extension office		
My county director is interested in using my evaluation results	.31	Moderate
My county director clearly communicates how evaluation results will be used	.29	Low
My regional director clearly communicates how evaluation results will be used	.17	Low
There is a strong interest in using data to make decisions in my extension office	.16	Low
My regional director is interested in using my evaluation results	.14	Low
The state extension director seeks evaluation information when making decisions	-.04	Negligible

Note. Magnitude: $.01 \geq R \geq .09 = \text{Negligible}$, $.10 \geq R \geq .29 = \text{Low}$, $.30 \geq R \geq .49 = \text{Moderate}$, $.50 \geq R \geq .69 = \text{Substantial}$, $R \geq .70 = \text{Very Strong}$.

Conclusions

This statewide study sheds light on the evaluation behaviors that extension professionals are engaging in. It also gives insight into how extension professionals perceive their personal use of evaluation procedures and results as well as their perceptions of how their Extension system as a whole values the use of evaluation. This study has shown extension professionals are engaged in a wide variety of evaluation behaviors. The majority are keeping program participation records (74.5%), conducting post tests of their activities (68.1%), and conducting post tests on their overall programs (54.3%). They are not using comparison groups as a control (5.1%) or conducting any type of inferential data analysis on their results (2.3%). This study supports Franz and Townson's (2008) claim that the majority of Extension professionals currently utilize posttests given at the conclusion of their educational activities to assess the level of success.

In general, participants tended to believe they used evaluation ($M = 3.90$, $SD = .63$) but had a more neutral perception of organizational use ($M = 3.23$, $SD = .74$). In addition, all but one personal perception of evaluation use items had a moderate correlation to evaluation behavior. Only two organizational perception of evaluation use item had a moderate correlation with the evaluation behaviors of extension professionals.

Implications and Recommendations

This study was designed to examine the direct use (Patton, 2008) of evaluation by extension professionals. Recall that direct use includes instrumental, conceptual, and process use (Patton, 2008). The findings of this study provide evidence that suggests extension professionals may use evaluation for instrumental use, as indicated by their tendency to believe evaluation is a critical tool for improving programs. To a lesser extent, conceptual use was evidenced as agents mostly thought it was true that they used evaluation to make decisions about their programs. Both findings are encouraging as they indicate a professional commitment to delivering quality programs. What may be more interesting, and concerning, to note from the findings of this study is not the direct use of evaluation by extension professionals but rather the implication that agents in this state believe their Extension system as a whole uses evaluation for political purposes.

According to Patton (2008), political use includes imposed use and mechanical use. Imposed use refers to evaluations conducted in response to mandates issued by those in power, such as a federal requirement. In fact, there are both state and federal requirements for Extension to report the number of people reached through extension programming and the demographic characteristics of those people. Mechanical use occurs when people go “through the motions” of evaluation simply to be in compliance with evaluation requirements (Patton, 2008, p. 112). The high percentages of extension professionals who reported keeping program participation records and tracking gender, race, and ethnicity as opposed to the percentages of extension professionals who used more rigorous evaluation methods such as pre/post tests, interviews to evaluate long-term outcomes, and control groups are clear indicators of imposed and mechanical use.

While it must be acknowledged that some extension professionals simply lack the evaluation expertise to perform behaviors such as measuring long-term outcomes or using advanced inferential statistics, the findings from this study suggest a substantial percentage of extension professionals are doing just enough to get by when it comes to evaluation. Franz and Townson (2008) also noted a tendency for extension professionals nationwide to use a low level of rigor when conducting evaluations. Program participation records, post-test only designs, and “interviews” (the quality of which is undetermined) are behaviors that require a minimal amount of effort, and produce little information that can be used to improve programs. Yet these are often good enough to satisfy organizational accountability requirements. The popularity of these methods is contradictory to the extension professionals’ purportedly strong beliefs that evaluation is a “critical tool for improving extension programs.” Note the item “critical tool for improving extension programs” $R = .28$ to evaluation behaviors, which is empirical support for a weak relationship. This should be cause for concern.

At the organizational level, extension professionals perceived their county and regional directors’ desire to have evaluation results to use was more evident than how the results would be actually used. Similarly, the extension professionals did not strongly agree that their state director used their evaluation results when making decisions. Clearer communication from administration would be helpful in demonstrating the value of evaluation beyond the role it plays in accountability.

Efforts to improve evaluation practices and culture need to be developed at the county level, rather than the result of administrative initiatives. The extension professionals in this study made their decisions about using evaluation largely independent of what they believed about how their county, regional, and state directors value and use evaluation. More plainly, extension professionals are likely to do what they are going to do, regardless of what administration tells them. Extension instead needs to focus on improving its culture of evaluation by building upon the positive relationship that was observed between evaluation use and evaluation discussion. Extension professionals who work in offices that talk about evaluation are more likely to conduct evaluation. Working directly *with* extension professionals to promote evaluation-oriented conversations, rather than just delivering more state-led in-service trainings and other top-down efforts, is a key step towards building an organizational culture that values evaluation.

Although many barriers exist in engaging extension agents in the practice of evaluation, they can be overcome. In order to gain more insight into the issues surrounding the challenges of getting extension agents to increase the amount of evaluations conducted, and the level of rigor in which

they approach evaluating programs, more research should be conducted. This study was specific to extension agents working in a single state and generalization beyond the population should be done with great caution. A study conducted to determine if extension agents working in other state extension systems (size, regional location, etc.) will assist in a broadening the interpretation of the results.

In addition, a study examining the impact different parts of the structure making up a state extension system (ie. professional development offered, communication, system-wide culture, work unit climate) has on evaluation use will offer administrators an idea of what is already working within their system and how to enhance what is not. In addition, research exploring why specific extension agents have chosen to evaluate their programs with a high level of rigor even though the majority does not would assist in gaining an understanding of how barriers against evaluation use have been overcome.

References

- Burke, W. W. (2008). *Organizational change: Theory and practice* (2nd ed.). Thousand Oaks, CA: Sage Publications.
- Cooperative State Research, Education, and Extension Service. (n. d.). *Financial education through taxpayer assistance impact report*. Retrieved from http://www.csrees.usda.gov/nea/economics/pdfs/05_motax.pdf
- Cronbach, L. (2000). Course improvement through evaluation. In D. I. Stufflebeam, G. F. Madoux, and T. Kellaghan (Eds.), *Evaluation models*. Boston, MA: Kluwer Academic Publishers.
- Culp, K., & Kohlhagen, B. S. (2004). Kentucky 4-H agents' perceptions of their levels of competency and frequency of use of volunteer administration function. *Journal of Agricultural Education*, 45(2), 1-13. doi: 10.5032/jae.2004.02001
- Cummings, S. R., & Boleman, C. T. (2006). We identified issues through stakeholder input: Now what? *Journal of Extension*, 44(1). Retrieved from <http://www.joe.org/joe/2006february/tt1.php>
- Davis, J. A. (1971). *Elementary survey analysis*. Englewood Cliffs, NJ: Prentice-Hall.
- Dillman, D. A., Smyth, J. D., & Christian, L. M. (2008). *Internet, mail, and mixed-mode surveys: The tailored design method* (2nd ed.). Hoboken, NJ: John Wiley & Sons, Inc.
- Franz, N. K., & Townson, L. (2008). The nature of complex organizations: The case of Cooperative Extension. In M.T. Braverman, M. Engle, M.E. Arnold, & R.A. Rennekamp (Eds.), *Program evaluation in a complex organizational system: Lessons from Cooperative Extension*. *New Directions for Evaluation*, 120, 5-14.
- Harder, A., Place, N. T., & Scheer, S. D. (2010). Towards a competency-based extension education curriculum: A Delphi study. *Journal of Agricultural Education*, 51(3), 44-52. doi: 10.5032/jae.2010.03044

- Kaplan, M., Liu, S., Radhakrishna, R. (2003). Intergenerational programming in extension: Needs assessment as a planning tool. *Journal of Extension*, 41(4). Retrieved from <http://www.joe.org/joe/2010june/a4.php>
- Meadows, D., Randers, J., & Meadows, D. (2004). *Limits to growth*. White River Junction, VT: Chelsea Green Publishing.
- Menalled, F. D., Grimberg, B. I., & Jones, C. A. (2009). Evaluation of agricultural professionals' perceptions and knowledge on sustainable agriculture: A useful step in the development of an online extension program. *Journal of Agricultural Education*, 50(4), 86-98. doi: 10.5032/jae.2009.04086
- Neal, J. W. (2010). The first 4 years of a warmwater recreational pond management web site in Arkansas. *Journal of Extension*, 48(3). Retrieved from <http://www.joe.org/joe/2010june/a4.php>
- Osborne, E. W. (Ed.) (2007). *National research agenda: Agricultural education and communication, 2007-2010*. Gainesville, FL: University of Florida, Department of Agricultural Education and Communication.
- Patton, M. Q. (2008). *Utilization-focused evaluation*, (4th ed.). Thousand Oaks, CA: Sage.
- Radhakrishna, R., & Martin, M. (1999). Program evaluation and accountability training needs of extension agents. *Journal of Extension*, 37(3). Retrieved from <http://www.joe.org/joe/1999june/rb1.php>
- Rasmussen, W. D. (1989). *Taking the university to the people: Seventy five years of cooperative extension*. Ames, IA: Iowa State University Press.
- Rogers, E. M. (2003). *Diffusion of innovations*, (5th ed.). New York: Free Press.

A Quantitative Analysis of the Efficacy of a Cross-Cultural Immersion Program for Extension Educators

*Jenna Brown, Dr. Maria Navarro, Dr. Dennis Duncan, Dr. Nick Fuhrman,
University of Georgia*

Abstract

As the United States becomes a progressively diverse nation, the need for a broader knowledge base of cultures and populations is imperative for the Cooperative Extension System. The objectives of this study are to explore and learn from the benefits, knowledge gained, and change of attitudes and practices resulting from participation in programs focusing in cross-cultural experiences. This study provides an analysis of a cross-cultural immersion program coordinated by Georgia Cooperative Extension. Better defined, this paper will further clarify the knowledge gained from participants, lessons learned, and provide recommendations to future cross cultural immersion programs. Cross-cultural immersion experiences provide participants the experience to visit a foreign country for a period of time with the goal of assisting participants in gaining knowledge regarding a specific culture. These immersion programs help participants discover key issues, cultural differences, and basic language skills with the hope that participants will be able to better relate and interact with the targeted population upon their return.

Introduction

Cooperative Extension spreads research-based knowledge to individuals regardless of their cultural backgrounds. As the United States becomes a progressively diverse nation, the need for a broader knowledge base of cultures and populations, and how to work with them, is imperative for the Cooperative Extension System. Everything from language, values, dress, religious persuasion, and family organization is changing before the eyes of Extension educators (Youmans, 2004). With these changes it is simultaneously necessary that leadership within the Extension System provide a welcoming environment to new cultures and new programming to better serve them.

The U.S. has grown in recent years into one of the most diverse nations. A specific group of individuals that has increased drastically in the U.S., and the South specifically, is the Hispanic population. "As of 2000, the Hispanic population of the United States (excluding the Commonwealth of Puerto Rico) reached 35.3 million, representing 12.5 percent of the total population." (Ansley & Shefner, 2009, p. 3). This specific population has been one that Cooperative Extension strives to provide help and effective programming for, even with the distinct dissimilarities between cultures and language.

Recently, states with large influxes of diverse populations have established cross-cultural immersion experiences for their personnel with the hopes of increasing the cultural competency of their staff. Georgia Cooperative Extension has established a cross-cultural immersion program for Extension agents to gain a broader knowledge of the population that they are serving. Better stated, with a radical increase in the Hispanic population, Georgia Cooperative Extension

established a cross-cultural immersion program in 2002 with the hopes of building the confidence of agents to serve Hispanic populations. The program provided international experiences for Extension educators which allowed them to immerse themselves in a Latin American country for two weeks. These two weeks were devoted to enhance the participant's ability to gain a better understanding of the Hispanic population, and cultivate the skills to address the needs that Cooperative Extension can meet.

One of the primary objectives of this research was to better define and construct the efficacy of the Georgia Cooperative Extension Cross-Cultural Immersion Program. Although there was not necessarily a problem with the system itself or the opportunity that it presents to its participants, it was intriguing to understand and better identify the benefits gained from individual participants, and their current relationship with the Hispanic population in their community. The researchers developed this study around the following assumptions:

- For a myriad of reasons, moving to a new place is incredibly challenging for any population;
- People seclude themselves from groups or cultures that are dissimilar to their own;
- People serving diverse populations find it very difficult to relate and establish programming for these populations; and
- Many individuals within Cooperative Extension find that they do not have adequate tools or the correct training for serving a diverse population.

An operational objective of the study was to further explore the ability of the Georgia Extension System in accomplishing the goals delineated of the Cross-Cultural Studies Program. Since its conception in 2002, Extension professionals have traveled each summer to Mexico, Costa Rica, Honduras, and Ecuador, and have returned to the United States with a new perspective on the Hispanic community. By better understanding communities that individuals have resided in before living in the United States, Extension professionals are better able to provide assistance for a selected group of people.

“The Cooperative Extension System today is a unique achievement in American education. It is an agency for change and for problem solving, a catalyst for individual and group action with a history of seventy-five years of public service. Extension brings the rewards of higher education into the lives of all segments of our extraordinarily diverse population” (Rasmussen, 1989, p. 3).

If a problem or miscommunication is understood between groups, agents are better able to create a welcoming environment for their potential participants because of their understanding of local issues. For some program participants additional services such as clothing, family acceptance, and transportation are helpful and agents can provide this support (Williams, 2001).

Literature Review/Conceptual Framework

In order for the Cooperative Extension System to remain effective in its position to spread research-based information to the public, Extension leadership must provide an atmosphere that permits professionals to continually develop their cultural competence. “Leadership must provide the environment that allows staff to learn new skills for designing

programs and to employ people from historically exclusive groups, while staff has to engage in the personal development work that will build a welcoming environment” (Schauber & Castania, 2001, para. 4). Through these cultural exchange and immersion programs, recognition of the global community individuals live in and share with others becomes a priority for the state system. These programs are used to engross professionals in a different culture while concurrently creating cultural competence. The University of Georgia began its Cross-Cultural Immersion Program in 2002, with its objectives defined as the following (Ames & Atilas, 2008, internal UGA document):

1. To provide participants with a knowledge of social, cultural, and environmental issues of Latin America,
2. To compare and contrast cultural values between Latin America and the United States and to interpret these values relative to the Hispanic and non-Hispanic communities in Georgia,
3. To learn about globalization and its impact on Latin America, and
4. To be exposed to basic Spanish language instruction to improve Extension professional’s language skills.

The University of Georgia is at the forefront of cultural immersion and exchange experiences. These experiences leave Extension professionals with a unique experience that is unforgettable and allows individuals to immerse themselves in a new perspective and way of life. Funding for Cross Cultural Immersion participants is provided in part by the USDA-CSREES International Science and Education Competitive Grants Program (Ames & Atilas, 2008). This funding allows participants the freedom to experience a different culture without the burden of expenses. A typical cross-cultural experience through the University includes a trip to a local University in the host country, numerous agricultural sites, social service agencies, public health clinics, and rural schools. The intention of visiting these various sites is to give participants a broad set of cultural experiences so that they can better understand, communicate with, and ultimately work more effectively with Latinos in Georgia when they return to the United States. Ideally, these travel experiences allow Extension professionals to be fully immersed in a new culture and therefore develop their own leadership capacity with diverse cultures. Upon their return, participants are expected to expound upon their current programs and share their experiences with other Extension educators across the state to encourage excitement and interest in the program.

“Submersion into another culture provides a perspective that, in some ways is difficult to transfer” (Marsden, 2000, para. 4), and immersion in a new place generates the ability of the participant to grasp a larger understanding of culture and is more easily accessible by being in the culture rather than learning about it. Place often lends itself greatly to ability of understanding and defines what is normative in a culture. The culture or norm of the United States varies greatly from that of a Latin American country. What is right as defined by place or space may not be the norm in a different place. The power of place in cultural and social practice should not be overlooked by the Cooperative Extension System. These immersion experiences lend themselves well to a larger discussion of the interaction between cultural groups, and create a more welcoming environment to include different groups and their beliefs in the current but every changing system of Extension. “Initiating the concept of leadership development in a global context and human capacity building might start with traveling outside the United States”

(Ludwig, 1999, para. 16). Through immersion and cross-cultural experiences, the Cooperative Extension System builds upon a heritage of relevant knowledge and inclusion of various groups and their individual history.

One of the operational objectives of this study was to determine the impact of a Cross-Cultural Immersion Program on participants, both professionally and personally. By gaining insight into their experiences both during and after the trip, recommendations can be organized for increased efficacy of the program for future trips.

The following six questions guided this research:

1. Demographically, what do participants of the Cross Cultural Immersion Program look like?
2. Are the goals of the Cross Cultural Immersion Program being achieved and acknowledged by participants?
3. Did participants receive personal and/or professional gain from the experience?
4. Did the participants' Extension programming change because of their experience in the program?
5. How confident are participants in their ability to serve the Latino population in their Extension programming?
6. What changes occurred in participants' Extension programming as a result of their participation?

As most participants completed the program more than a year ago, the basic premise was to gain pertinent information regarding the usefulness of the program (including long term impact), and offer suggestions and guidance for future programs

Research Design

Survey research design methodology was used in this study. The Tailored Design Method was also used to “create respondent trust and perceptions of increased rewards and reduced costs for being a respondent, which take into account features of the survey situation and have as their goal the overall reduction of survey error” (Dillman, 2000, p. 27). This design enabled the researchers to collect information from Cross-Cultural Immersion participants regarding their experiences and increased the sense of reward for participants as their contributions would be recognized and shared with Cooperative Extension leadership.

Population

The population of this study included 53 Cross-Cultural Immersion participants with Georgia Cooperative Extension. An administrator of the program provided basic contact information, including email addresses, for participants from the 2002, 2004, 2005, 2006, 2007, and 2008 Cross-Cultural Immersion Programs. Of the 53 prior participants, 6 were regarded as coverage error as they had retired from the University system and were unable to be contacted. This allowed for a total population of 47 participants.

Instrumentation

A questionnaire was constructed in December 2009 to evaluate the personal and professional benefits gained from the Cross Cultural Immersion Program, and to gather feedback on any modifications previous participants may have made in their Extension programming following the experience. The survey was constructed using *Survey Monkey* and consisted of 32 questions. Twenty-one questions were traditional Likert items and grouped in the analysis in six constructs: 1) Program objectives; 2) Personal and professional; 3) Professional only; 4) Personal only; 5) Programming; and 6) Ability to serve). The Likert items were based on a typical five-level system and included the responses Not Very (coded as 1), Somewhat, Fairly, Very, and Extremely (coded as 5). Five questions included yes, no, and unsure responses; three questions required open-ended responses; and five questions pertained to demographics.

Data Collection Procedures

Following the Tailored Design Method, an email was sent to all participants on February 12th, 2010, informing the selected population that they would be asked to participate in a survey on February 15th, 2010. This email gave full information regarding the research, and included the expected length of time the survey would take. A second email was sent on February 15th to all participants created from the cover letter of the survey, which included a link to the questionnaire on the *Survey Monkey* website. Reminder emails were sent on February 19th and March 5th. A follow-up email was sent to participants on March 8th. Participants were given 6 weeks to complete the survey before it was closed and results were analyzed. Early respondents were identified as completing the survey before March 1st, 2010 and late respondents were regarded as completing the survey on or after March 1st, 2010. Early and late respondents were compared statistically using t-tests, with a significance level of $\alpha = 0.05$ set a priori, and no significant differences were identified.

Data Analysis Procedures

All data was collected in an excel spreadsheet from *Survey Monkey* and transferred into SPSS, version 17.0, for further analysis. Frequencies were calculated for all demographic information, including gender, amount of education completed, age, current job title, and years of experience in Extension. The survey included questions grouped in six constructs: 1) Program Objectives; 2) Personal and Professional Gain; 3) Personal Gain Only; 4) Professional Gain Only; 5) Extension Programming; and 6) Ability to Serve the Hispanic Population. These constructs were created from the dominant domains that emerged from preliminary interviews conducted during a pilot study. Each construct's reliability was tested using Cronbach's alpha. Cronbach's alpha levels above 0.70 were accepted as being of sufficient internal consistency (Santos, 1999). The qualitative data from the instrument (responses to open-ended questions) was analyzed using domain analysis and grouped into 6 dominant domains, for each question, based on the frequency of the response. This qualitative information is presented in another manuscript.

Of the 47 prospective research participants, 32 responded to the questionnaire (68% response rate). To assess non-response error, we compared responses between early respondents and late respondents, using the assumption that late respondents are more similar to non-respondents than early respondents (Dillman, 2000). To strengthen value to the analysis, we compared responses for the research constructs rather than just demographic data (Navarro, 2004). In a t-test analysis (*a priori* $\alpha = 0.05$), no significant differences were found between early and late respondents for any of the constructs of the study.

Results

1. Demographically, what do participants of the Cross Cultural Immersion Program look like?

Demographic information for the participants of the purposive sample chosen for this study is presented below. Thirty-two previous Cross-Cultural Immersion participants responded to the survey, including 16 males (50%) and 16 females (50%). Education was defined based on 6 different levels which included High School, Technical/Vocational School, Bachelor's Degree, Master's Degree, Doctoral Degree, and Professional Degree. Of the 31 responses, 54.8% ($n=17$) indicated that they had completed a Master's Degree, 32.3% ($n=10$) had achieved a Bachelor's Degree, and 12.9% ($n=4$) had obtained a Doctoral Degree (Table 1).

Table 1

Highest Amount of Education Completed (n=31)

Education Level	<i>f</i>	%
High School	0	0
Technical/Vocational School	0	0
Bachelor's Degree	10	32.3
Master's Degree	17	54.8
Doctoral Degree	4	12.9
Professional Degree	0	0

On the survey, participants were asked to provide the year that they were born. Once responses were collected, age was further defined by the decade in which the participant was born to simplify the data analysis. Most of the respondents were born between 1950 and 1959 (Table 2).

Table 2

Age of Participants (n=30)

Year Born	<i>f</i>	%
1940-1949	2	6.7
1950-1959	12	40.0
1960-1969	7	23.3
1970-1979	4	13.3
1980-1989	5	16.7

Table 3 shows the responses regarding the question: *What is your current title?* In the online survey, respondents were allowed to type their response, without any options. Of the 33 responses, 75.8% ($n=25$) were categorized as Non-Administrator. Some of the responses for this item included *County Extension Agent, County Extension Coordinator, 4-H Agent, Extension*

Specialist, Public Service Assistant, and Professor and Extension Vegetable Specialist. Six respondents, (18.2%) were denoted as Administrators where responses included *Center Coordinator, County Director, Director of County Operations, Director of International Special Projects OVPPSO, Family and Consumer Sciences Program Development Specialist, and Program Development Coordinator.* The remaining respondents were retired (Table 3).

Table 3

<i>Current Job Title (n=33)</i>		
Job Title	<i>f</i>	<i>%</i>
Administrator	6	18.2
Non-Administrator	25	75.8
Retired	2	6.0

Table 4 identifies the year in which the respondent attended the Cross-Cultural Immersion Program. Respondents were again allowed to type in their response with no options given, and 27 participants responded to this question. Most of the respondents participated in the Cross Cultural Immersion Program in either 2007 or 2008 (Table 4).

Table 4

<i>Year Attended Cross Cultural Immersion Trip (n=27)</i>		
Year Attended	<i>f</i>	<i>%</i>
2 Years	1	3.7
2002	2	7.4
2004	1	3.7
2006	4	14.8
2007	9	33.3
2008	10	37

2. Are the goals of the Cross Cultural Immersion Program being achieved and acknowledged by participants?

Reliability and summated scores of each of the constructs on the questionnaire are presented in Table 5. The reliability of each of the 6 constructs was assessed using Cronbach's alpha. Construct 1 identifies if respondents acknowledge and concur with the identified program goals of the Cross-Cultural Immersion Program. For the survey's purpose, these goals were re-iterated immediately before Questions 1 through 6 on the questionnaire. Analyzed results show that a reliability score of .825 was given with a mean summated score of 23.88 (SD = 3.48) out of a possible maximum score of 30 and a minimum score of 6. This shows that, in general, respondents acknowledged and achieved the program's goals.

Table 5

Construct Reliabilities & Summated Scale Scores

Items(n)	Construct Name	Reliability (Cronbach α)	Summed Score (SD)	Min/Max
1-6 (6)	Program Objectives	.825	23.83 (3.48)	6/30
7-12 (6)	Personal & Professional Gain	.898	21.09 (4.28)	6/30
9-10,12 (3)	Professional Gain Only	.830	10.33 (2.217)	3/15
7-8,11 (3)	Personal Gain Only	.806	10.76 (2.278)	3/15
13-18 (6)	Programming	.938	15.77 (6.22)	6/30
19-21(3)	Ability to Serve	.833	10.13 (2.5)	3/15

3. Did participants receive personal and/or professional gain from the experience?

The professional gain construct (Table 5) consisted of three questions with a reliability score of .830 and a mean response of 10.33 (SD = 2.217) out of a possible maximum score of 15 and a minimum score of 3. The personal gain construct (Table 5) also consisted of three questions with a reliability score of .806 and a mean response of 10.76 (SD = 2.278) out of a possible maximum score of 15 and a minimum score of 3. These constructs indicated that respondents felt that they received both personal and professional gain from the Cross-Cultural Immersion Program.

4. Did the participants' Extension programming change because of their experience in the program?

Overall, respondents indicated for the first five questions in this section that their programming had changed somewhat since their participation in the Cross-Cultural Immersion Program with individual item mean scores of 2.45 (SD = 1.18), 2.71 (SD = 1.1), 2.32 (SD = 1.32), 2.26 (SD = 1.24), and 2.65 (SD = 1.25) respectively. The last question of this section resulted in an overall higher response concerning the participants increased confidence in working with the Georgia Latino population with a mean of 3.39 (SD = .98) (Table 5).

5. How confident are participants in their ability to serve the Latino population in their Extension programming?

All 3 questions in this construct aimed to understand how confidently participants felt in working with and creating programs for the Georgia Latino population. This construct shows that, in general, participants felt fairly confident in their ability to work with and create programs for the Georgia Latino population after their participation in the Cross-Cultural Immersion Program (Table 5).

6. What changes occurred in participants' Extension programming as a result of their participation?

For each of these questions participants were given the option of 3 responses: Yes, No, and Unsure.

The first question asked: *Do you feel that you have been given all the tools to serve the Latino population successfully?* Of the responses, 31.3% ($n=10$) responded Yes, 25% ($n=8$) indicated No, and 43.8% ($n=14$) answered Unsure.

The second question asked: *As a direct result of your participation in the Cross-Cultural Immersion program have you implemented new or more successful programming in your county/community?* Of the responses, 54.8% ($n=17$) answered Yes, 35.5% ($n=11$) responded No, and 9.7% ($n=3$) indicated Unsure.

The third question asked: *As a direct result of your participation in the Cross-Cultural Immersion program has your daily job been affected or changed?* Of the responses, 43.8% ($n=14$) answered Yes, 43.8% ($n=14$) responded No, and 12.5% ($n=4$) indicated Unsure.

The fourth question posited: *Would you suggest the Cross-Cultural Immersion program to other agents?* Of the responses, 100% ($n=32$) answered Yes.

The last question of Research Finding 6 asked: *Would you participate in the Cross-Cultural Immersion program again?* Of the responses, 96.9% ($n=31$) answered Yes, 3.1% ($n=1$) responded No, and 0% ($n=0$) indicated Unsure.

Conclusions and Recommendations

Although respondents had a broad array of thoughts and feelings about their Cross-Cultural Immersion trip, the general consensus of the data is that this program is a positive force for education and change among Cooperative Extension and further demonstrates that “The new millennium will offer many challenges to Extension. Recognition of the global community we inhabit and share with partners around the world will become an increasing priority” (Ludwig, 1999, para. 20). Georgia Cooperative Extension has made vast strides with their Cross-Cultural Immersion Program to recognize and reorganize their Extension agents and professionals to become more accepting and tailored to the global community that we inhabit. From the research conducted with this survey, recommendations will be made to further improve the Cross-Cultural Immersion Program for Georgia Cooperative Extension. These recommendations include:

1. Future research be conducted both pre and post Cross-Cultural Immersion trip to gauge the participants change as a direct response to the program.
2. Further qualitative research be conducted with prior Cross-Cultural Immersion participants as a follow-up to this research study.
3. Continued research be conducted regarding both the personal and professional gain that participants receive. Qualitative data from the preliminary interviews suggests that participants received more personal than professional gain from this experience, while the results from this survey indicate that participants received similar amounts of both personal and professional gain.
4. A competitive selection process, which could include an interview and in-depth application, be implemented for the Cross-Cultural Immersion Program. This process might eliminate agents or professionals who do not actively seek to create more effective programming for the Latino populations within their community or county. Proactive

Extension agents and professionals that would implement programming after their trip would only be accepted to the program.

5. Research be conducted on how to implement effective programming for Latino population post-trip. Data from this research study shows that participants did not know how, or were not given the tools, to implement new programming, or alter existing programming, following their Cross-Cultural Immersion trip.
6. Participants be held accountable for their trip to create buy-in from participants. Suggested methods could include proof of additional programming, follow-up interviews or progress forms, and informational presentations to other Cooperative Extension agents and professionals to promote the program and further disseminate knowledge gained from the experience.
7. Post trip meetings be established with all prior participants to provide a larger network of knowledge transfer. This could provide an avenue for participants to share success stories, problems, and further communicate concerning the Cross-Cultural Immersion Program in general.
8. Additional training, education, and tools be provided to Cooperative Extension agents and professionals that will aid their endeavor to assist the Latino population in Georgia.

As the United States becomes a progressively diverse nation, the need for a broader knowledge base of cultures and populations is imperative for the Cooperative Extension System. With initiatives like Georgia Cross Cultural Immersion Programs, marginalized groups are provided better access to more tailored and culturally sensitive programming. It is this programming that will be vital in Cooperative Extension's quest to become more diverse and better applicable.

“Every agency of government is established and budgeted on the premise that the agency serves people. Perhaps different agencies serve different constituencies, but the concept of service to people is fundamental. The agency that loses sight of this basic requirement of service will eventually lose sight of its own purpose and objectives...agencies are meant to be appendages to the people's will; to be effective, the agency staff must be sufficiently skilled and trained to give dimension and structure to the people's needs so that they can be defined, articulated, and acted upon” (Veri & Vonder Haar, 1970, p. 1).

References

- Ames, G. C. & Atilas, J. H. (2008). *Learning for life: Cross-cultural studies to enhance outreach programming for [State's] changing demographics*—A focus on Mexico. The University of Georgia internal document (formerly available at <http://www.uga.edu/internationalpso/mexico08report.html>).
- Ansley, F., & Shefner, J. (Eds.). (2009). *Global Connections & Local Receptions: New Latino Immigration to the Southeastern United States*. Knoxville, TN: The University of Tennessee Press.
- Dillman, D. A. (2000). *Mail and Internet Surveys: The Tailored Design Method* (2nd ed.). New York, NY: John Wiley & Sons, Inc.

- Ludwig, B. (1999). Globalizing Extension Professionals. *Journal of Extension*, [On-Line], 37(4). Available at: www.joe.org/joe/1999august/rb5.html.
- Marsden, A. (2000). Walking the Mile Barefoot. *Journal of Extension*, [On-Line], 38(6) Article 6COM2. Available at: www.joe.org/joe/2000december/comm2.php
- Navarro, M. (2004). *Analysis of Factors Affecting Participation of Faculty and Choice of Strategies for the Internationalization of the Undergraduate Agricultural Curriculum: The Case in Two Land Grant Universities*. Unpublished doctoral dissertation, Texas A&M University, College Station.
- Rasmussen, W. D. (1989). *Taking the University to the People: Seventy-five Years of Cooperative Extension*. Ames, IA: Iowa State University Press.
- Santos, J. R. A. (1999). Cronbach's Alpha: A Tool for Assessing the Reliability of Scales. *Journal of Extension*, [On-Line], 37(2) Article 2TOT3. Available at: www.joe.org/joe/1999april/tt3.php
- Schauber, A. C., & Castania, K. (2001). Facing Issues of Diversity: Rebirthing the Extension Service. *Journal of Extension*, [On-Line], 39(6) Article 6COM2. Available at: www.joe.org/joe/2001december/comm2.php.
- Veri, C. C., & Vonder Harr, T.A. (1970). *Training the Trainer*. St. Louis, MO: Extension Division, University of Missouri.
- Williams, B. (2001). Accomplishing Cross Cultural Competence in Youth Development Programs. *Journal of Extension*, [On-Line], 39(6). Available at: www.joe.org/joe/2001december/iw1.html.
- Youmans, D. (2004). Toward Cross-Cultural Outreach: The Washington State Experience. *Journal of Extension*, [On-line], 42(2). Available at: www.joe.org/joe/2004spril/iw2.shtml.

4-H Volunteers Intent to Support Youth with Disabilities: An Elicitation Study

Ms. M. Jo Monroe, Dr. Curtis R. Friedel, Louisiana State University

Abstract

This initial study served as an elicitation study to elude commonly held beliefs shared by the target population in the three content areas of the Theory of Planned Behavior; behavioral beliefs, normative beliefs, and control beliefs (Ajzen, 1991). The study questions allowed for indirect measurements of attitude, subjective norms and perceived behavioral control. Using the Theory of Planned Behavior, formative research was required to construct a questionnaire suitable for establishing the beliefs and behaviors of the population of interest. To assess beliefs, they must be elicited from a sample demographically similar to the research population. This initial study surveyed 4-H volunteer leaders in Louisiana to uncover factors that influence their support or non-support of youth with intellectual and developmental disabilities in 4-H club activities. 4-H volunteer leaders revealed advantages/disadvantages, referents approving/disapproving, and perceived barriers/supports of supporting youth with intellectual and developmental disabilities in 4-H club activities. Responses will be used to construct a list of modal salient beliefs for the purpose of constructing a standard questionnaire

Introduction and Literature Overview

Youth with disabilities benefit from inclusion in 4-H programming (Tatman, 2006); a fact recognized by the Cooperative Extension Service for over 50 years. In accord with this recognition, 4-H adopted an open door policy toward youth with disabilities ahead of federal disability legislation mandating inclusion rights of all persons with disabilities (Van Horn, Flanagan, & Thomson, 1999). However, the inclusion of youth with intellectual and developmental disabilities (IDD) into 4-H programming presents a unique challenge to many 4-H volunteer leaders. With over 450,000 4-H leaders nationwide, adult volunteers are often the primary 4-H contact youth encounter. A review of the literature found only one study that specifically investigated the perceptions of 4-H volunteers towards working with youth with disabilities. In this study, Coleman and Booth (1984) reported only 16% of volunteers surveyed indicated an adequate level of training to work with youth with disabilities and 86.5% indicated a need for training in this area. Despite reported training inadequacies, 77% of volunteers reported a willingness to accept youth with disabilities as members of a 4-H club. Note that Coleman and Booth's study was conducted before the passage of the Americans with Disabilities Act in 1990, but there was still a sense of commitment from volunteers indicating their desire toward involving youth with disabilities in 4-H programs. Does this high percentage of volunteers' willingness reflect an intention of these individuals to exhibit inclusionary behavior? According to the Theory of Planned Behavior (TPB), people act in accordance with their attitudes (Ajzen & Fishbein, 2005), regardless of training; implying if volunteer leaders today continue to possess such a strong positive attitude, then youth with IDD currently benefit from inclusion in 4-H programming. But, how does one properly ascertain these attitudes leading to intentions?

Theoretical Framework: The Theory of Planned Behavior

Advanced by Icek Ajzen (1991), the TPB has been used extensively to model the determinants of human social behavior. Since the early 1980's, TPB, a revision of the Theory of Reasoned

Action (TRA), has been considered by researchers to be one of the most influential theories in establishing the link between intentions and behavior, and was a valuable tool for predicting a wide range of behaviors (Sheppard, Hartwick, & Warshaw, 1988).

In explaining TPB, Ajzen (1991) posits that the immediate antecedent to a behavior is intention to perform the given behavior. In turn, intentions are strongly influenced by three factors: attitude toward the act or behavior, subjective norms, and perceived control over the behavior (Figure 1). Attitude refers to a person's overall evaluation of performing the behavior. Subjective norms refer to perceptions about how significant others would judge a person for performing the behavior. Perceived behavioral control refers to the self-assessment of both the capability and the opportunity to perform the behavior. Underlying these three factors are, respectively, behavioral beliefs, normative beliefs, and control beliefs (Ajzen & Fishbein, 1980). Behavioral beliefs are assessments about the likelihood of the behavior's consequences (Ajzen & Fishbein). Normative beliefs are assessments about what important others might think of the behavior (Ajzen & Fishbein). Control beliefs are assessments of the ease or difficulty of performing the behavior and the perceived power of resources, skills, and opportunities for the behavior (Ajzen & Fishbein). Behavioral intention is then formed from the combination of attitude toward the behavior, subjective norm and perception of behavioral control (Ajzen & Fishbein). As a general rule, a positive attitude and favorable subjective norm, coupled with perceived control, should positively influence the person's intention thereby leading to performance of the behavior. Assuming an opportunity exists, the TPB provides an explanation of how people may expect to carry out their intentions, provided they possess a sufficient degree of actual control over the behavior.

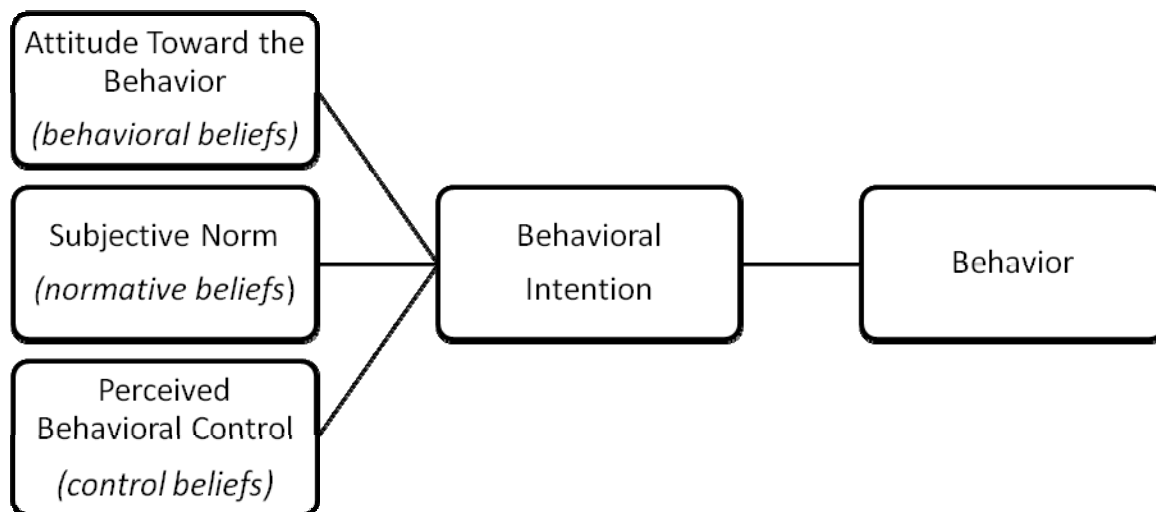

Figure 1. Theory of Planned Behavior (Ajzen, 1991).

Using TPB to explain behavior, intentions may be predicted with considerable accuracy from measures of the behavioral, normative and control beliefs (Ajzen & Cote, 2008). Belief measurements provide substantive information about the cognitive foundation of people's

behavior (Ajzen & Fishbein, 1980). Cognitive foundation can be explored by eliciting salient beliefs about the attitude object, the behavior, and assessing values associated with the different beliefs. Assessments of belief values lend the TPB its predictive utility for behavior.

Eliciting salient beliefs. To create a fundamental base for the cognitive foundation of the population's behavior, Ajzen and Fishbein (1980) advocate the use of an elicitation study. An extensive review of TPB studies indicates an extended explanatory utility of TPB in studies employing an elicitation study prior to the construction of the primary questionnaire (Downs & Hausenblas, 2005). The purpose of the elicitation study is to determine the behavioral, normative and control beliefs of a population through the following recommendations: (a) conduct an elicitation study with open-ended questions; (b) perform a content analysis to rank-order the beliefs; and (c) determine the five to ten most salient beliefs. Beliefs that are recorded most frequently are included in the modal set and are used as the basis for the quantitative measures of beliefs. Ajzen & Fishbein (1980) suggest choosing as many beliefs as necessary to account for 75% of all beliefs elicited for determining the final set of salient beliefs.

In TPB, salient beliefs are the first answers that come to mind when respondents are asked open-ended questions such as "what do you think would be the advantages for you of performing behavior 'X'?" Salient beliefs are also referred to as accessible beliefs (Ajzen & Fishbein, 2000). The TPB is specified at the level of the individual, thereby postulating that an individual's salient behavioral beliefs determine his/her personal attitudes toward the behavior. In practice, however, it is more convenient to identify the set of beliefs that are salient in a given population (Ajzen & Fishbein, 1980).

The use of elicitation studies is important to identify the salient beliefs of a specific population versus the general population. Not all people share the same thoughts and feelings about youth with IDD; therefore, to generate a study questionnaire based on general attitudinal responses towards youth with IDD would limit the explanatory power of the TPB. Ajzen's recommendation of a purposeful sample was followed thereby boosting the utility of TPB for explaining the psychosocial and cognitive determinants of behavior (Ajzen, 1991).

Purpose

The primary purpose of the current study was to identify TPB constructs (behavioral beliefs, normative beliefs, and perceived control beliefs) associated with the intention of 4-H volunteer leaders to support youth with IDD in 4-H club activities. The responses were used in two ways: 1) to construct a list of modal salient beliefs providing the basis for constructing the standard questionnaire to be used in a subsequent study; and 2) to reveal the content that may be encountered in the subsequent study.

Methods

Instrumentation

Following Ajzen's procedure for TPB questionnaire construction (2002), the behavior under study was defined as supporting youth with IDD in 4-H club activities. The study questions were written to ascertain (1) the perceived advantages and disadvantages of performing the behavior (behavioral beliefs); (2) the most important people who would approve or disapprove of the behavior (normative beliefs); and (3) the perceived barriers of facilitating factors which could make it easier or more difficult to perform the behavior (control beliefs). Using a qualitative

approach, open content analysis (Riffe, Lacy, & Fico, 1998) was used to thematically code and rank-order the responses to these questions by frequency. From this list, the authors selected as many themes as necessary to account for 75% of all beliefs elicited. Credibility was established with the use of three separate researchers reviewing, discussing, and agreeing on the themes.

Subjects

The sample for this study was a convenience sample of Louisiana 4-H volunteer leaders. Volunteer leaders attending the Louisiana 4-H Volunteer Leader Conference in Baton Rouge, LA were chosen to participate. Purposeful sampling may boost the researcher's ability to understand intention and behavior and to predict its impact on the study group, thereby increasing generalization to the target population. The lead researcher approached all volunteer leaders registered for the conference ($n = 34$) as they entered the registration area and during the introduction of the study to ascertain their initial willingness to participate. All attendees agreed to participate and signed an IRB-approved consent form. From this, 29 completed the study instrument at their convenience during the weekend. The total of 29 exceeds the recommended elicitation sample size of 25 (Ajzen & Fishbein, 1980) and therefore suitable for this study. The subjects were all female ranging in age from 26 to 73 years. The average age in the group was 47 years-old. The reported years of service in Louisiana 4-H range from one to 30 years with an average tenure of 12.6 years.

Procedures

Once the 4-H conference convened, the lead researcher was allowed to address the volunteer leaders. The purpose of the study was clarified and key terms within the instrument were defined. The subjects were reminded the instrument was to be answered from a personal perspective of advantages/disadvantages, approval /disapproval, and ease/difficulty, not from a third-party perspective of youth with IDD. Participants were given definitions for two key terms in the instrument; *support* and *youth with intellectual and developmental disabilities*. For the purposes of this study, the researchers defined *support* as *purposeful actions* of the volunteer leader to ensure full participation of youth with IDD in 4-H club activities. Examples of *support* include, but were not limited to: direct recruitment of youth with IDD for 4-H membership; planned modification of club programs and club activities to accommodate and/or benefit youth with IDD; searching for and/or requesting suitable modifications for youth with IDD to compete with 4-H members without IDD on a more even playing field; confirming the presence of or securing the availability of any physical modifications necessary for a youth with IDD to fully participate in all 4-H club activities. To define *youth with intellectual and developmental disabilities*, the subjects were presented the definition from the American Association on Intellectual and Developmental Disabilities (Schalock, Borthwick-Duffy, Buntinx, Coulter, & Craig, 2009). In the final section of the instrument, participants were asked to identify their gender, age and tenure of 4-H volunteer service.

Results

Behavioral Beliefs

Behavioral, or attitudinal, beliefs are the cornerstone of a person's attitude. Attitude refers to a person's overall assessment of performing a behavior; and the consequences, whether positive or negative. The behavioral beliefs underlying the assessment are based on the perception of the consequence occurring. These beliefs, regardless of their soundness or reality, produce a

favorable or unfavorable attitude toward a behavior. To assess behavioral beliefs, participants were asked to identify personal advantages and disadvantages associated with supporting youth with IDD in 4-H club activities. Rank ordered by response theme frequency, the results were presented in Table 1 with themes totaling 75% in bold.

Table 1

Rank-order of elicited behavioral beliefs (advantages, disadvantages, and other)

Behavioral Beliefs	Rank-order
Values based	1 (22.8%)
Added burden	2 (19.3%)
Emotional reactions	3 (12.3%)
Lack of knowledge	4 (10.5%)
Personal enhancement	5 (8.8%)
Social enjoyment	6 (7.0%)
Threat to personal -emotional or physical	7
Aversion to weakness	8
Extrinsic values/recognition	9

Note. Items in bold indicate themes totaling 75%.

Values based. Respondents cited advantages with values based themes as the strongest behavioral belief at 22.8% overall. More than one-half of respondents touched on humanitarian values. Persons who act with humanitarian interests were devoted to the promotion of human welfare and the advancement of social change. 4-H volunteer leaders, as a whole, exemplify these values in their personal adoption of the 4-H motto: “To make the best better”. The response *“being a part of something that is making 4-H better for everybody”* (Participant 12) embodies this value. By exhibiting a commitment to improve the lives of others, 4-H volunteer leaders acknowledge the benefits of inclusive programming for enhancing self-esteem and providing a sense of belonging. *“These kids need to be included like everyone else. Being included helps these students feel like they are a part of something. I can be a positive influence on a child’s self-esteem”* (Participant 19). Another prominent value described by 4-H volunteer leaders in their responses was equality. Participant 2 surmised: *“I help make these children feel like they are like everyone else.”* Religious value was illuminated by Participant 24: *“I feel like this is my calling in life. God has given me the patience to work with these youth.”*

Added burden. Responses coded as being related to the ‘job’ of volunteering in 4-H appeared in 19.3% of the overall responses as disadvantages of supporting youth with IDD in 4-H club activities. Examples of tasks associated with volunteering with 4-H that would be amplified negatively by the presence of youth with IDD was cited as: extra time requirement, added work, more one-on-one attention, and added pressure. Participant 5 noted this disadvantage with an added liability: *“Preparing separate activities takes a lot of time and takes me away from the other youth in the club.”* This liability was also noted by Participant 6: *“Meeting their needs may slow the progress of a ‘regular’ group in the type of activities that are planned and the amount of activities that can be carried out in a club meeting”* (sic; notation by respondent). Also coded in this theme were responses related to “job descriptions” perceived by 4-H leaders. Responses along this line ranged from obligation, *“It is a part of my job as a volunteer. I really don’t have a choice”* (Participant 31), to duty, *“I knew that I would have youth of all kinds and backgrounds join my club and it was my responsibility to treat them all fairly”* (Participant 22).

Emotional reactions. Responses coded as emotional reactions encompassed primarily inward emotions such as fear or pity expressed by the volunteers as opposed to outward emotions such as anger or displays of prejudice. Some of these inward emotions, as expressed here, were often veiled in a context of concern for the person with IDD. This context of concern was evidenced in 4-H volunteers by responses like: *“I am afraid they will get hurt or injured under my watch”* (Participant 20) and *“I feel sorry for them when they are not able to keep up”* (Participant 22). Emotional reactions of other 4-H members were noted by Participant 2: *“Sometimes other students may be scared of these students.”* For some 4-H volunteer leaders, the emotional reaction of fear manifested as a fear of legal exposure: *“I could be sued if something happened to one of these youth while at a 4-H function with me”* (Participant 18) and *“it exposes me to extra liability”* (Participant 27).

Lack of knowledge/experience. Volunteers were able to assess their personal levels of knowledge and/or experience and expressed the lack thereof as a disadvantage to supporting youth with IDD in 4-H club activities: *“I am really unsure with kids with disabilities because I have not read a lot about disabilities. I really wish 4-H would offer us more specific training on how to deal with these youth”* (Participant 1). *“I don’t know enough about mental disorders to feel comfortable dealing with them one on one”* (Participant 26). *“Not all adults are trained to work with special needs children”* (Participant 9). Participant 17 indicated a lack of knowledge that stems from an information base provided by the youth with IDD: *“Children with cognitive impairments usually have IEPs at school that we are not allowed to see or read. Most have numerous accommodations and modifications that need to be followed for meaningful learning to take place. Without access to those IEPs, it is practically impossible for us to know how to help them.”* Whereas most parents enrolling a youth with IDD would be forthcoming concerning any necessary accommodations for their child, it was not the policy of 4-H to require that any disclosures be made as to the presence of a disability of a youth enrolling in 4-H.

Personal enhancement. The opportunity to grow and develop psychologically was a benefit cited as an advantage to supporting youth with IDD in 4-H club activities. Examples of personal enhancement posited by 4-H volunteer leaders include: *“Makes me a more well-rounded person”* (Participant 3), and an increase in *“self-respect and a strong feeling of worth”* (Participant 23). Participant 4 concluded: *“I have gained a new perspective on my quality of life.”* While these responses may reflect more egocentric advantages than the altruistic advantages of values based responses, both themes were identified as advantages for supporting youth with IDD.

Social enjoyment. Social enjoyment was a motivator for a multitude of activities. While some people may equate personal pleasure as solely egocentric, this theme harkens to the brand of personal enjoyment that was experienced by filling our leisure time with projects and experiences that cognitively stimulate and regard as meaningful. For a few respondents, personal enjoyment was cited as a bonus of helping others. Enjoyment was summed up by Participant 4: *“It just makes me feel really great to see these youth succeed in the 4-H activities.”*

Normative beliefs

People are influenced by the opinions of other significant persons. Social pressure to perform or avoid a behavior is influential on persons of any age and contributes to the formation of

normative beliefs. Normative beliefs result in perceived social pressure or subjective norms. In order to elicit subjective referents, respondents were asked to identify groups or individuals that would approve or disapprove of the respondent supporting youth with IDD in 4-H club activities. The referents were rank ordered by frequency of category and presented according to approval/disapproval in Table 2.

Table 2
Rank-order of elicited normative beliefs

Normative Beliefs	Rank-order
Approval	
Professional groups	1 (28.1%)
Parents of youth with IDD	2 (21.9%)
Persons experienced with youth with IDD/Teachers	3 (18.8%)
Professional Peers	4 (15.6%)
Everyone (collective response)	4 (15.6%)
Disapproval	
No one would disapprove	1 (75.9%)
Personal relationships	2 (10.3%)
Parents of other 4-H members	3 (6.9%)
Other 4-H members	3 (6.9%)

Groups/individuals approval. Professional groups were the strongest category of approving referents cited by volunteer leaders at 28.1%. The vast majority of the groups listed were youth development groups much like 4-H. Examples were Boy Scouts/Girl Scouts, Boys and Girls Clubs, Special Olympics and church organized groups. Advocacy groups, such as the Arc of the United States and Families Helping Families, were cited as supportive of youth development organizations that support inclusion. Schools hosting 4-H clubs were examples also included in this category. The strongest category of individuals cited as approving were parents of youth with IDD. Participant 12 noted that in the course of her job as a special education teacher she was “*constantly aware of parents of my students that are looking for extra-curricular activities for their children.*” She continued by recording her response to the parents as, “*I always recommend 4-H to them as a suitable activity.*” The approval from parents of youth with IDD often spills over to active support as Participant 23 noted: “*I have a parent of a handicapped girl that comes to every activity and helps with every child, not just hers. She is a great asset to my club.*”

The category of experienced referents was primarily comprised of persons with personal experience (other than a child) and special education teachers. A recurring note within this category addresses the capacity of teachers to “*recognize the need for positive youth development skills*” (Participant 16) among youth with IDD and applauds a “*willing[ness] to lend a hand*” to club activities. Lastly, volunteer leaders report approval from persons categorized as professional peers and ‘everyone’ as significant to supporting youth with IDD. The peers listed most frequently were other 4-H volunteer leaders and persons employed with the volunteer leader.

Groups/individuals disapproval. 4-H volunteer leaders responded overwhelmingly (75.9%) that no one would disapprove of supporting youth with IDD in 4-H club activities. This category

by itself fills the criteria of themes representing 75% of total responses, but it was worthwhile in this study to review the categories comprising 24% of the total disapproval responses. Approximately 10% of volunteers reported a personal relationship as a disapproving individual. Participant 8 wrote: *“My husband would not want me to encourage them to come to the farm.”* Two respondents listed their personal children, both 4-H’ers in the club, as persons that would disapprove. The only comment offered as to their children was one of discomfort being around youth with IDD.

Two additional disapproving individuals were cited as being parents of other 4-H members and other 4-H members. While not a majority of the responses, these two categories bear report in this section. Respondents cited primarily self-centered reasons for the disapproval from these two categories: *“Parents of my regular club members would not approve. They would feel that their child is not getting the attention they need to prepare for state-level competitions”* (Participant 13). *“The other 4-H members might feel uncomfortable if the disabled youth was very different in appearance or mannerisms”* (Participant 7). Salient responses appear to reflect genuine concern while other responses appear to be conjecture or speculation about people who might disapprove.

Control Beliefs

Control beliefs provide the basis for perceived behavioral controls. The perceived ease of performing the behavior coupled with the perceived power over resources, skills and opportunities work together to form a control belief. If a person believes they lack resources and opportunities as well as anticipating obstacles to the behavior, the result was a lower control belief toward the behavior, often surmised with statements like “it’s out of my hands”. Respondents were asked to disclose factors or circumstances that enable or inhibit their support of youth with IDD in 4-H club activities. Response themes were rank ordered by frequency and presented in Table 4 with themes totaling 75% in bold.

Assistance from others. The traditional format of 4-H club programming often finds the volunteer leader as the sole adult in club meetings and activities. While this format may not be problematic for groups that were basically homogeneous in abilities and/or interests, the dimension of diversity adds complexity to programming for solo leaders. Respondents reported assistance from others, the presence and the absence thereof, as the strongest factor enabling or inhibiting, respectively, their ability to support youth with IDD in 4-H club activities.

Typically, the assistance noted as enabling was from persons with professional backgrounds relating to youth with IDD. The vast majority of these respondents named special education teachers as their most valuable asset. It was worthwhile to note here that Louisiana 4-H clubs were often organized within the local schools as extra-curricular activities, thus increasing the potential availability of assistance from special education teachers. Outside of school programming, Participant 24 commented their *“club meetings are held at the parish office so that way I am never left alone. I can always defer to my agent to assist with areas of concern,”* acknowledging assistance from the 4-H agent as enabling. When assistance from others was reported as an inhibiting factor, the majority of respondents named the parents of the youth with IDD. The assistance needs cited by these participants ranged from transportation to assistance with projects, indicating the need as one of physical presence of the parent.

Table 4

Rank-order of elicited perceived control beliefs (enabling, inhibiting, other)

Control Beliefs	Rank-order
Assistance from others- presence/lack of	1 (26.8%)
Experience-presence/lack of	2 (12.5%)
Personal hardships	3 (10.7%)
Distractions from youth with IDD	4 (8.9%)
Risk of liability	4 (8.9%)
Situational	4 (8.9%)
Fear of unknown	7
Values based	8

Note. Items in bold indicate themes totaling 75%.

Experience. As with assistance from others, the theme of experience, whether present or lacking, was the next highest control factor, enabling or inhibiting respectively. This experience was professional as well as personal. For example, “*As an educator, I interact with youth with IDD on a daily basis*” (Participant 32) and “*I have training in special education. I have inclusion youth in my classroom*” (Participant 24) were responses from teachers who volunteer in 4-H. On a personal level, experience came from relationships with family members or friends: “*I have extensive experience with youth with IDD as I have multiple family members that are affected.*” (Participant 3), and “*A former colleague of mine has a daughter with IDD who is very active in our 4-H program*” (Participant 11) were cases of two such relationships. Inhibitions were cited as lack of certification (although not required in 4-H programming) and concern for health issues; for instance, “*Not having ever worked with youth with IDD, I would be nervous about medical issues*” (Participant 18).

Personal hardship. Two issues related to personal hardships recurred as inhibiting factors for volunteers: extra time required and added work. For most adults, volunteering was an activity to which they allocate their spare time, making time a limited resource outside of family and/or work responsibilities. The responses related to time issues did not specify if the respondent perceived that more time would be required or had prior experience confirming that more time was required. General responses such as “*Time is a real big constraint*” (Participant 15) gave no clue as to what aspects of supporting youth with IDD require extra time. Only one participant specified these aspects as modifying lessons and activities to accommodate the youth with IDD.

Distractions, risk of liability, and situational factors. The final three themes all appeared as factors that would inhibit a volunteer from supporting youth with IDD in 4-H club activities. Participant 23 responded from personal experience with a previous 4-H member with IDD and noted that managing her behavior “*kept me from being able to do a lot of activities with the non-disabled kids.*” Similarly, participant 8 noted: “*The distractions cause a problem. Sometimes the attention is taken off whatever is important, like the meeting or activity.*”

Some volunteers believe their personal risk of liability was increased by the presence of youth with IDD in their supervision. None of the respondents offered examples where they personally had been held liable or sued for any incidents. The standard of care required of volunteer leaders by 4-H towards youth under their supervision was the same for all youth, regardless of ability. However, the perception of an increased level of risk remains an inhibiting factor in this study.

Lastly, a few respondents gave examples of inhibitors that were themed as situational. Examples were: *“Having access to suitable livestock for them to handle safely”* (Participant 11). *“The physical arrangements that may be needed to assist them”* (Participant 31). *“Special transportation could be a factor that makes it difficult”* (Participant 14).

Discussion

In accordance with recommendations of Ajzen and Fishbein (1980), an elicitation study was conducted in order to identify behavioral, normative and control beliefs relevant to the support of youth with IDD in 4-H club activities by 4-H volunteer leaders. The volunteer leaders chosen for the sample identified with consistency the advantages/disadvantages of supporting youth with IDD in 4-H, people who they believed would approve/disapprove of engaging in such behavior, and factors that would make supporting youth with IDD in 4-H easy or difficult.

Behavior themes identified for the belief-based attitude measures were: values based, added burden, emotional reactions, lack of knowledge, personal enhancement, and social enjoyment. According to Clary, Snyder, Ridge, Miene & Haugen (1998), values based reasons serve as the strongest function served by volunteering, allowing individual volunteers to express or act on a personally important value. In addition to values, volunteers in the Clary, et.al. study also cite personal enhancement as a motivator for volunteer service. Consequently, Clary, et.al. (1998) also suggest that items, coded here as added burden, are among the top reasons why volunteers quit. The emotional reactions identified by the volunteers are among the reactions identified in the Multinational Study of Attitudes toward Individuals with Intellectual Disabilities as major obstacles for people with IDD (Siperstein, Norins, Corbin & Shriver, 2003). Multiple studies cite lack of knowledge and experience as hindrances to successful inclusion of youth with IDD in schools, extension programming and similar settings (Brandon & Ncube, 2006; Cormody, Seevers, Andreasen, & VanLeeuwen (2006); Boone, Boone, Reed, Woloshuk & Gartin, 2006).

The referents recognized for the belief-based measure of subjective norms were: professional groups, parents of youth with IDD, persons/teachers with experience in IDD, professional peers, personal relationships, and other 4-H members and their parents. Pender and Pender (1986) suggest that, for most behaviors, people identify immediate family members, persons in direct authority and friends/peers among the most influential persons.

Finally, the themes identified for the belief-based measures of perceived behavioral control were: assistance from others, personal experience, personal hardship, distractions from youth with IDD, risk of liability, and situational factors. Empirical evidence from the literature previously cited supports the presence of similar factors in research on volunteering and inclusionary efforts with youth with IDD.

Figure 2 represents the modal salient beliefs identified in this study and the proposed influence on behavioral intention as theorized by Ajzen and Fishbein (1980).

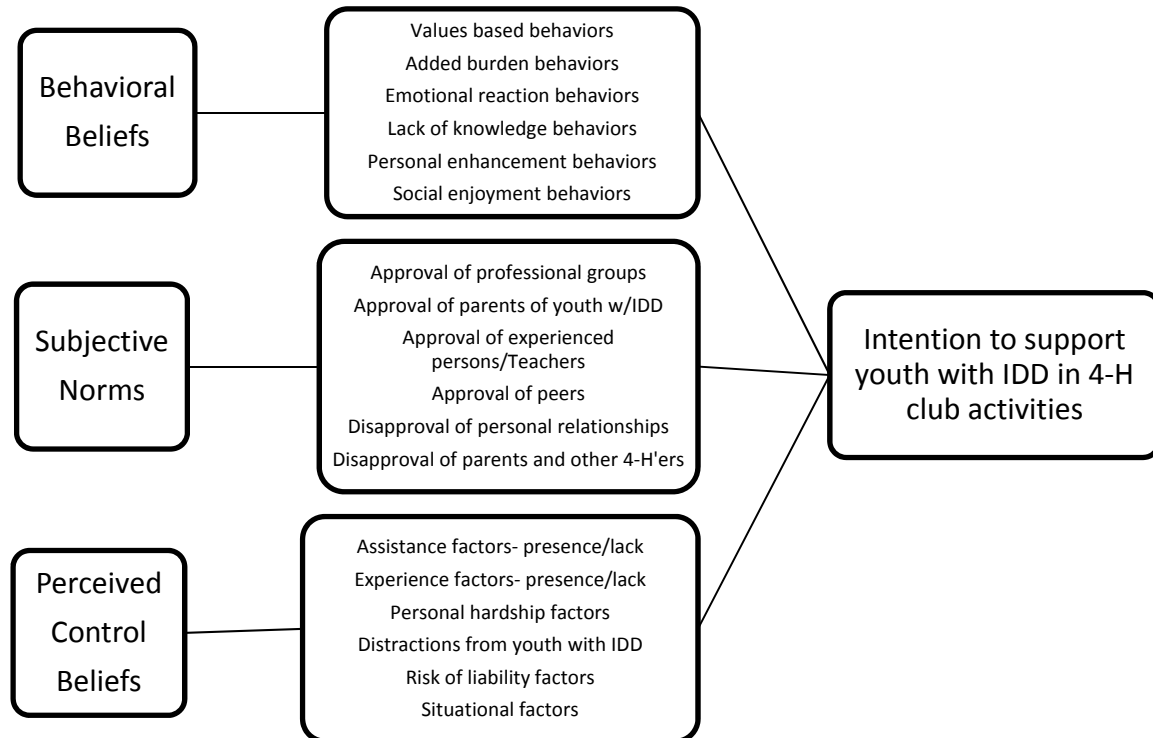

Figure 2. Salient beliefs of behavioral intentions of 4-H volunteer leaders

Conclusions

This instrument provided direct measures of attitudes, subjective norms, perceptions of behavioral control, intentions, and actual behavior. The identification of beliefs readily accessible in memory, i.e., salient beliefs, has provided the basis for the construction of a standard TPB questionnaire. When cautiously reviewed, these salient beliefs may provide an initial explanatory function to gain preliminary insight into the underlying cognitive foundation of behavioral intentions. Ajzen (1980) posits that the value of such an early “snapshot” of the behavior’s foundation is one of early intervention. Early interventions that could benefit the population might be focused training, face-to-face discussions, mentoring, or other applicable methods (Ajzen & Fishbein, 1980).

It was worthwhile to note that according to the TPB, behavioral intentions are linked to beliefs (Ajzen, 1991); however the veridicality of these beliefs was not addressed. For the belief-based measures to contribute to the prediction of the behavior in question, it is imperative for the responses to be authentic. The beliefs identified represent the information people presently hold about a behavior. When considering an early intervention, it is important to consider the source of respondents’ information influencing their belief. The important methodological implication of this conclusion is an identified need for a combination of qualitative research methods to provide and enrich the surface connections suggested in the inherently quantitative approach defined by the TPB. Unfounded beliefs exist and people may act accordingly regardless of evidence or knowledge. Only when beliefs accurately reflect reality may one expect interventions to be effective. Issues revealed in this study such as the need for certification and increased risk of personal liability suggest that when cautiously evaluated in the context of an explanatory pre-intervention study, 4-H professionals may consider an indication for altering

cognitions and behavior in a more supportive direction. The occurrence of beliefs that are potentially based on mis-information provides a potential avenue for early interventions among volunteer leaders. 4-H has a clear stance on such issues and increased education could reduce these factors as beliefs influencing behavioral intentions.

Whereas some issues of veridicality could be resolved through education, other issues revolve around beliefs grounded in personal experience versus perception. Beliefs derived from perception, i.e. myths, could be altered by empirical evidence and mentoring. Volunteer leaders may shy away from supporting youth with IDD because they *perceive* negative situations. Examples of positive situations that directly dispute perceptions could diminish stereotypical generalizations. Volunteer leaders that have successfully supported youth with IDD in 4-H club activities should be encouraged to share their strategies and experiences. Issues such as additional workload and time could be addressed by making volunteers aware of resources with modifications and lesson plans readily available through 4-H. Assistance from others, or lack thereof, is an early intervention area that could be addressed immediately. Despite the traditional club format, solo leadership by a volunteer should be assessed by Extension personnel to identify any potential inhibitors to inclusionary efforts.

In conclusion, the beliefs elicited in this study are important as factors that may be used to predict the behavior of 4-H volunteer leaders to support youth with IDD in 4-H club activities. However, it is important to immediately consider the influencing factors surrounding these beliefs and the significant role they potentially play in actual behavior. The issues identified could have important implications for the development of advanced communications and sensitized strategies directed at increasing inclusionary support efforts of youth with IDD into 4-H programming. Because a convenience sample was used, the reader is urged to interpret these findings with caution. A larger sample of volunteer leaders is crucial to assess the stability of these beliefs and their impact on behavior. This survey may provide a cognitive basis from which to derive broader inferences and generalizations on the identified areas imperative to a deeper understanding of supporting youth with IDD in 4-H programming.

References

- Ajzen, I. (1991). The theory of planned behavior. *Organizational Behavior and Human Decision Processes*. 50. 179-221.
- Ajzen, I. (2002). Perceived behavioral control, self-efficacy, locus of control, and the theory of planned behavior. *Journal of Applied Social Psychology*. 32, 665-683.
- Ajzen, I. & Fishbein, M. (1980). *Understanding attitudes and predicting social behavior*. Englewood Cliffs, NJ: Prentice-Hall.
- Ajzen, I. & Fishbein, M. (2000). Attitudes and the attitude-behavior relation: Reasoned and automatic processes. *European Review of Social Psychology*. 11. 1-33.
- Ajzen, I., & Fishbein, M. (2005). The influence of attitudes on behavior. In D. Albarracín, B. T. Johnson, & M. P. Zanna (Eds.), *The handbook of attitudes* (pp. 173-221). Mahwah, NJ: Erlbaum.

- Ajzen, I., & Gilbert Cote, N. (2008). Attitudes and the prediction of behavior. In W. D. Crano & R. Prislin (Eds.), *Attitudes and attitude change* (pp. 289-311). New York: Psychology Press.
- Armitage, C.J. & Conner, M. (2001). Efficacy of the theory of planned behavior: a meta-analytic review. *British Journal of Social Psychology*, 40, 471-499.
- Boone, D., Boone, H., Reed, C., Woloshuk, J., & Gartin, S. (2006). Attitudes of Extension professionals toward involvement of special needs youth in 4-H programs. *Journal of Extension* [On-line], 44(6). Available at: <http://www.joe.org/joe/2006December/a4p.shtml>
- Brandon, D. P., & Ncube, M. M. (2006). Botswana's agriculture teachers' attitudes towards inclusion of students with physical disabilities in mainstream classes. *The Negro Educational review*, 57, 215-227.
- Clary, E.G., Snyder, M., Ridge, R.D., Miene, P., & Haugen, J. (1994). Matching messages to motives in persuasion: A functional approach to promoting volunteerism. *Journal of Applied Social Psychology*, 24, 1129-1149.
- Coleman, B.M. & Booth, N. (1984). 4-H and the Handicapped: Volunteers' Perceptions. *Journal of Extension*, 22(1). Online at <http://www.joe.org/joe/1984january/>
- Dormody, T.J., SeEVERS, B.S., Andreasen, R.J., & VanLeeuwen, D. (2006). Challenges experienced by New Mexico Agricultural Education Teachers in including Special Needs Students. *Journal of Agricultural Education*, 47(2). 93-105.
- Downs, D., & Hausenblas, H. A. (2005). Exercise behavior and the theories of reasoned action and planned behavior: A meta-analytic update. *Journal of Physical Activity and Health*, 2, 76-97.
- Francis, J.J., Johnston, M., Eccles, M.P., Grimshaw, J. & Kaner, E.F.S. (2004). Measurement issues in the Theory of Planned Behavior. Manual supplement for the Centre for Health Services Research. Appendix C. University of Newcastle, UK.
- Godin, G. & Kok, G. (1996). The theory of planned behavior: a review of its applications to health-related behaviors. *American Journal of Health Promotion*, 11(2). 87-98.
- Grimshaw, J.M., Shirran, L., Thomas, R., Mowatt, G., Fraser, C., Bero, L., Grilli, R., Harvey, E., Oxman, A. & O'Brien, M.A. (2001). Changing provider behavior: an overview of systematic reviews of interventions. *Medical Care* 39(suppl 2):2-45.
- Hunt, C.S. & Hunt, B. (2004). Changing Attitudes Toward People with Disabilities: Experimenting with an Educational Intervention. *Journal of Managerial Issues*, 16(2). 266-280.

Pender, N.J., & Pender, A.R. (1986). Attitudes, subjective norms, and intentions to engage in health behaviors. *Nursing Research*, 35. 15-18.

Riffe, D., Lacy, S., & Fico, F.G. (1998). Analyzing media messages: Using quantitative content analysis in research. Mahwah, NJ: Lawrence Erlbaum Associates.

Schalock, R.L., Borthwick-Duffy, S.A., Buntinx, H.E., Coulter, D.L., Craig, E.M. (2009). *Intellectual Disability: Definition, Classification, and Systems of Supports (11th Edition)*. American Association on Intellectual and Developmental Disabilities.

Sheppard, B. H., Hartwick, J., & Warshaw, P. R. (1988). The theory of reasoned action: A meta-analysis of past research with recommendations for modifications and future research. *Journal of Consumer Research*. 15. 325-343.

Siperstein, G. N., Norins, J., Corbin, S., & Shriver, T. (2003). *Multinational study of attitudes toward individuals with intellectual disabilities*. Washington, DC: Special Olympics.

Tatman, P. (2006). 4-H: An Exclusively Inclusive Program. University of Wyoming Cooperative Extension Service. Available at:
<http://uwadmnweb.uwyo.edu/wyo4h/Inclusive/intro.pdf>

Van Horn, B.E., Flanagan, C.A., & Thomson, J.S. (1999). Changes and Challenges in 4-H (Part 2). *Journal of Extension*. 37(1). Online at
<http://www.joe.org/joe/1999february/comm1.php>

Session I Agricultural Education: Laboratories
and Mechanization Bayfront Corpus Christi Ballroom C

**Economic Impact of Agricultural Mechanics Competition Projects in (State) and Factors
that Predict Chapter Investment Value: State Returns from 2009-2010**

*Roger Hanagriff, Gary Briers, John Rayfield, Tim Murphy, Texas A&M University;
Doug Kingman, Sam Houston State University*

Abstract

The educational value of experiential learning is widely accepted (Kolb, 1984). Supervised Agricultural Experience (SAE), as an anchor for experiential learning, is a well-documented, valuable, and integral part of agricultural education programs (Deyoe, 1953; Moore, 1988; Cheek, Arrington, Carter, & Randall, 1994; Dyer & Osborne, 1996; Bryant, 2003; Roberts & Harlin, 2007). Cole and Connell (1993) found that there was little research regarding the economic value of SAEs; they suggested that measuring the cost and economic benefits of SAEs would provide valuable information in communicating additional benefits of SAE programs. This study found that 45% of chapters are involved in agricultural mechanics show projects, and this portion of (State) programs are creating \$10 million in economic impacts to the (State) economy. It was also determined that programs with agricultural mechanic show projects are more active in using record books, larger programs and have improved local support over non-participating programs. This study also found demographic variables such as numbers of teachers, students, higher community support and miles traveled significantly correlated to higher investment cost of agricultural mechanics SAEs, again illustrating the economic value of this educational area. These economic impacts are important significant values and should be reported to school stakeholders. Methods of assessment should be improved to provide more accurate estimates of value, and economic values should be considered as an aspect of program assessment.

Introduction

Previous research has linked the educational value of an SAE to student achievement and knowledge (Cheek, Arrington, Carter, & Randall, 1994; Dyer & Osborne, 1996). The educational purposes and objectives built into SAEs benefit students by challenging them to gain new skills and experiences (Bryant, 2003). However, an SAE requires additional investment costs such as travel and supplies, which usually are funded outside of the educational system. According to Shinn (1987), approximately two-thirds of instructional time in agricultural education programs is devoted to laboratory instruction. Typically, laboratory instruction requires a large financial investment, including the cost of consumable supplies and equipment assets. This research reviews the educational intent and value of SAEs, examines previously completed research in economic valuation of SAE programs and agricultural mechanics SAEs, and determines the economic value of agricultural mechanics SAEs to the Texas economy.

Financial support is required to support agricultural mechanic SAEs, and financial support is more likely to be obtained when there is a corresponding economic return coupled with educational value.

Review of Literature

The educational value of experiential learning is well established (Kolb, 1984). Experiential learning has been an integral component of agricultural education since passage of the Smith-Hughes Act in 1917. This act required that supervised farm projects be an integral part of all agricultural education programs (Deyoe, 1953; Moore, 1988, 2003). Our understanding of these supervised experiences was broadened and modernized in 1988 when The Committee on Agricultural Education in Secondary Schools released a report recommending that “emphasis should be placed on the experience and entrepreneurship, not only on the occupation” (Moore, 1988, p. 41).

The educational value of supervised experiences has been well documented in agricultural education literature (Roberts & Harlin, 2007). Over time, “the purposes of projects in agricultural education have expanded beyond skill acquisition and proficiency to include personal development for diverse career preparation beyond agriculture” (Roberts & Harlin, 2007, p. 53). Although many types of supervised experiences are now embraced, those that focus on entrepreneurship have long been central to agricultural education.

Newcomb, McCracken, Warmbrod, and Whittington (2004) found that SAEs allow students to apply practices and principles learned in the classroom and to develop new skills and abilities through involvement in SAEs. Further, the authors concluded that supervised experiences also improve learning, student personal development, and occupational development. Case and Stewart (1985) indicated that students with both ownership and placement SAE projects came from schools with stronger programs. In other words, strong SAE student involvement is linked to strong programs.

Extensive evidence of the educational value of the SAE exists in the literature, but the value of SAEs from an economic standpoint is not as well understood. In 1985, the Western Region of the American Association for Agricultural Education recognized the importance of this question by including the economic assessment of SAEs among their regional research emphasis areas. Eight years later, Cole and Connell (1993) reported that studies had been completed in the Western Region on leadership and advancement of educational progress, but none of them was related to economic assessment.

Several approaches to determining the economic value of SAEs have been reported in the literature. Cole and Connell (1993) completed a study measuring the economic impact of Oregon agriculture science and technology programs by examining teacher salaries (program value). They found that the average annual agriculture program value was \$143,763. They recommended conducting additional research using cost/benefit analysis to compare the costs associated with the program to economic benefits of the program. Christiansen (1999) reported

that assessing economic value of SAEs was timely given the current climate of depressed times and lower funding. West and Iverson (1999) evaluated 174 agricultural education programs and determined that the local economic impact of SAEs per program in Georgia was \$71,344, with a total value to the state of \$12 million.

In Missouri, Graham and Birkenholz (1999) used SAE labor (placement) income to calculate program value. Retallick and Martin (2005) used similar indicators in an eleven-year study (1991–2001) to identify the economic impact of placement SAEs in Iowa. Another method for measuring economic value of SAEs would be to determine the value of the expenses in specific SAE areas, and then use those investment values to derive the economic impact from such spending.

A widely-used method to measure economic value is Impact Analysis for Planning (IMPLAN). This input-output database and modeling system produces multiplier values from economic models to estimate the economic impacts of spending on a region's economy (Alward, 2008). Blackwell, Cobb, and Weinberg (2002) used IMPLAN in their research, and encouraged additional research in the area. Arik and Nsiah (2004) measured the economic impact of Middle Tennessee State University; they reported that the direct economic impact consisted of the initial change in expenditures by the university. The University of New Mexico concluded that IMPLAN is a widely-used tool for measuring the impacts to the local economy (Norton, 2004).

However, while available research addressing the economic value of SAEs includes a variety of approaches to determining the value, none has used IMPLAN and the research done provides little insight into the economic value of agricultural mechanics SAEs specifically.

Purposes / Objectives

The purpose of this study was to address the recommendations of Cole and Connell (1993), who suggested a cost/benefit approach to measuring programmatic value. The study further focused that recommendation on agricultural mechanics SAEs. The specific objectives of the study were to (1) measure how investment in agricultural mechanic show projects differ from mechanics SAE values; (2) determine the different types of agricultural show mechanics projects and average cost per project; (3) calculate investment costs in agricultural mechanics show projects in a local program and identify descriptive factors related to higher investment cost; and (4) estimate the total economic impact from agricultural mechanic show projects to the local agricultural education program and to Texas.

Methods

The population for this descriptive study was agricultural education programs in Texas, which included 975 programs. A census was attempted with all 975 programs contacted and requested to provide data.

A researcher-developed survey instrument was examined for content validity by a set of Texas agricultural education teachers and the director of agricultural at Texas Education Agency. The survey instrument was administered through Survey Monkey[®] with respondents replying to questions regarding program characteristics and involvement in standard types of agricultural mechanics projects; the standard types were agricultural machinery and equipment, electrical, livestock equipment, trailer equipment, tractor restoration, BBQ pit, and wood projects. These project categories are generic contest categories used in many Texas agricultural mechanics SAE events. Activity in each project type consisted of numbers of projects in the program and average cost for a project of that type (investment cost). A Cronbach's alpha (.895) determined the internal reliability of the survey using 15 questions that measured programs involvement, levels of support from program stakeholders and involvement in agricultural mechanics projects.

Following Dillman's (2000) recommendations, the researchers distributed the survey instrument via email to agricultural science teachers in Texas. Emails were sent to the 975 agricultural education programs. Following the initial request with two reminder emails resulted in 460 programs completing the survey instrument. A late series of follow-up emails was sent, with 31 additional programs responding. The 491 usable responses received represented 50% of the agricultural education programs in Texas and the response rate for this study.

Economic values are represented by reported direct investment costs needed to complete an agricultural mechanics show projects and their associated economic impact using the IMPLAN model, which as previously mentioned is an input-output model. In this study, the related IMPLAN values for Texas were \$1.80 for expenditures. Spearman correlations were used to examine relationships of demographic or program characteristics to economic impact. Magnitude of the correlations was interpreted using the Davis Convention (1971).

Handling non-response error, and its threat to external validity, the researchers followed suggestions outlined in Lindner, Murphy, and Briers (2001). In this study, their method 1 procedure for handling non-responses was used. They recommended that if late respondents did not differ from early respondents, then results could be extrapolated to the population. The final attempt to collect responses resulted in a final "wave" of 31 respondents who were identified as late respondents and used as a comparison group to the 460 early respondents. Using analysis of variance, no statistically significant differences existed (α set at .05) between early and late respondents. Because no differences were found, late respondents were included in the sample and results were extrapolated to the population of Texas agricultural education programs (N=975).

Results / Findings

The 491 programs included in the data reported enrollment of 77,978 students. According to Texas Education Agency, the 2008 school enrollment included 99,281 students in agricultural education, an average of 101 students in each of the 975 programs. Texas Education Agency also reported that 90% of programs offer agricultural mechanics courses each year. The average program in this sample reported 162 students, which is a higher average student involvement value per program than average state reporting. In this sample, 225 of the 491 programs (45%)

were involved in agricultural mechanics show projects. Considering the total 975 programs, this sample estimates 439 programs in Texas have programs that invest in agriculture mechanic projects.

Based on sample results, Texas programs had an average of two teachers; teachers had an average of 14 years of professional experience. Programs also reported an average of 13,829 annual travel miles and 48 hotel rooms used and serve as a measure of program involvement. Programs (through the teacher or teachers together) also reported the perceived values of financial support from their school, booster club, and community, which uses a likert type scale of no support available (1), no support (2), low support (3), average support (4) and high support (5). The average program reported financial support from their school as average (3.9) while booster club financial support is lower (3.6) with non-financial community support rating as average to high (4.3).

Agricultural mechanic show project programs compared to non-participating programs and recognition of involvement in agricultural mechanics SAEs. To determine if agricultural mechanic projects are an area of focus, analysis of variance was completed on common demographic variables. In terms of program demographics, chapters with agricultural mechanic show projects are significantly higher ($\alpha < .05$) in agricultural education students (179 to 141, $p=0.02$), students in FFA (106 to 74, $p=0.00$), students maintaining record books (68 to 50, $p=.043$), financially supported (4.0 to 3.8, $p=.038$) and greater community support (4.22 to 4.07, $p=.007$).

Analysis of variance was also completed to determine if chapters participating in agricultural mechanics competitions are also programs reporting agricultural mechanic SAEs, which would determine if this research validates a non-represented group. In relation to chapters that recognize participating in show projects, they report significantly ($\alpha < .05$) lower involvement in reporting agricultural mechanic SAEs (1.3 to 1.7, $p=0.00$). This illustrates that agricultural mechanic show projects are not always reported as normal SAEs and therefore not accurately measured in the economic aspects of SAE reporting.

Agricultural mechanics show projects and associated investment costs. To determine investment costs, respondents reported average investment costs to support the development of each project. The economic investment values of corresponding agricultural mechanics projects by project area are listed in Table 1.

Table 1
2008-09 School Year Investment Cost per Agricultural Mechanics Project

Project Area	Chapter Frequency <i>f</i>	Mean of Reported Average Investment Cost (MRAIC) (<i>M</i>)
Machinery & Equipment	115	\$1,136
Electrical	11	\$573
Livestock Equipment	76	\$587
Trailer	69	\$2,493
Tractor Restoration	20	\$4,708
BBQ Pit	79	\$536
Wood	64	\$258

The instructions requested that respondents include only purchase of materials and supplies needed to complete the project. This excludes capital costs (e.g., welders or other equipment and tools) and labor needed for project development or construction, since these cost would extend beyond annualized cost.

Agricultural education programs were most likely to report that their students participated in machinery and equipment SAEs, with 115 of the 225 programs reporting projects in that area. Following machinery projects, livestock equipment ($f=76$) and trailer ($f=69$) SAEs. The mean reported average investment cost (MRAIC) is calculated from the reported average to produce each agricultural mechanics show project. The highest investment requirements were for trailer and tractor restoration projects.

Costs of program’s agricultural mechanics SAE projects and descriptive factors related to higher investment cost. To determine the average cost for a program’s investment in agricultural mechanics project, the frequency (number) of projects and their associated average cost need to be associated to develop total cost for each project area across all reporting programs. Table 2 illustrates the numbers of projects in each category, and the total value invested in each area.

Table 2
Frequency of Projects and Total Estimated Investment Cost using Average Cost

Project Area	Frequency of Projects (<i>n</i>)	Average Investment Cost per Project (<i>M</i>)	Average Program Investment Cost (<i>M</i>)	Total State Investment Cost ($439=s$)
Machinery & Equipment	1,096	\$1,136	\$5,532	\$2,428,699
Electrical	47	\$573	\$120	\$52,520
Livestock Equipment	648	\$587	\$1,690	\$741,852
Trailer	175	\$2,493	\$1,939	\$851,311
Tractor Restoration	29	\$4,708	\$607	\$266,361
BBQ Pit	698	\$536	\$1,664	\$730,367
Wood	950	\$258	\$1,089	\$478,129
			Total	\$5,549,240

Note. Total investment cost is determined by multiplying average program investment cost per project area by estimated 439 programs participating in agricultural mechanics projects.

As illustrated in Table 2, the most frequent project is machinery and equipment and is the highest total investment value to (state) and reporting \$2.4 million in total spending. Table 2 illustrates the frequency of each project, average cost and average value per responding program estimate programs in (state) to represent \$5.5 million for 439 programs in Texas. Considering the previously mentioned 439 programs estimated to be involved in these projects, the average involved program spends \$12,640 in investment cost related to agricultural mechanic projects. However, this represents only programs that reported involvement in agricultural mechanic SAEs and not the responses of all 975 programs. The final objective was to identify

demographics related to investment cost of agricultural mechanics projects. Table 3 defines demographic variables related to agricultural mechanics investment cost.

Table 3

Program Demographics Statistically Significantly Correlated to Agricultural Mechanics Investment Cost (Spearman Correlation)

Demographic Area	<i>R</i>	<i>n</i>	<i>Correlation Interpretation (Davis, 1971)</i>
Number of Teachers	.25	143	Low
Number of Students in Program	.28	143	Low
Level of Community Support	.24	178	Low
Total Annual Miles Traveled	.27	143	Low

Note. Correlations significant at .05 level

Table 3 used Davis (1971) to interpret the magnitude of each correlation. Statistically significant, low, positive correlations were found with agricultural mechanics SAE investment value and number of teachers, number of students in the program, level of community support, and annual miles traveled. Thus, higher agricultural mechanics SAE were associated with higher numbered teacher programs, more students in the program, higher level of community support, and greater number of annual miles traveled, which was related to a research objective.

Total economic impact from agricultural mechanics SAE projects. As previously outlined by Norton (2004), economic impacts can be determined by using expenditure costs and applying the IMPLAN multiplier value to estimate total economic impact, which can be a valuable tool to policy makers. As previously mentioned, the reported spending of all programs in Texas on agricultural mechanics programs is \$5.5 million.

The economic value of this spending represents additional “ripple” effects in (State) economy that occurs from spending related to producing these SAE projects. Using the \$5.5 million in estimated total direct spending, the economic impacts from this spending are estimated to be \$10 million (\$5.5M * 1.80 IMPLAN Type II Value).

Conclusions

This approach offers a new assessment approach and an additional assessment variable by determining economic values of this experiential learning area. The first objective was to measure if agriculture mechanics show projects are part of the normal SAE process and demographic profile of programs participating in this area. Programs not reporting involvement in agriculture mechanic show projects actually report greater involvement in agricultural SAE projects, which identify chapters participating in show projects are likely not reporting those as SAEs. Also, programs that reported involvement in agriculture show projects also were larger programs with higher student involvement, higher involvement in record books and greater support by their school and local supporters.

The second objective was to quantify the different types of agricultural mechanics SAE projects and associated investment costs. The highest individual project investment costs were for tractor restoration and trailer projects. It appears that machinery and equipment trailers are the third highest investment area, but the highest state valued investment cost with the more chapters reporting involvement than other areas.

The third objective was to develop the average and total cost for agricultural mechanics projects and determine correlations with agricultural investment cost. There were significant relationships with greater numbers of teachers, higher program enrollment, great community support and greater annual travel miles. The correlation of size for programs (teachers and students) is not a surprise as programs need size to accomplish projects. Community involvement may be related to the need for external support to complete the financial obligation for projects. Also, these values serve as guidelines for students interested in participating in these areas.

The fourth objective was to measure the total economic impact from investment cost for agricultural mechanics SAE projects in (State). Findings indicate \$5.5 million in total state investment costs and \$10 million in economic impacts, which are significant annual values to a state's economy. Also, these values are driven by only 45% of programs; obviously, greater involvement in terms of higher percentage of programs will increase total economic values to Texas.

Recommendations

The current economic condition of today matches the situation outlined by Christiansen (1999), making this review of economic value timely. Additional study is needed to measure the economic values of SAEs and their relationships to greater student involvement. More narrowly defined project areas by levels of cost, or types of projects within an area, would be beneficial.

Steps were taken to ensure accurate results and comparison of early and late respondents used to extrapolate to the population, but the risk still exists that only more active programs responded. Improved data collection methods would create more accurate values of involvement and economic value. Additionally, an effort to bring agriculture mechanic SAE reporting and agriculture mechanic show projects into one educational effort would improve valuation.

Further research should be conducted to establish the local and state economic value of agricultural education programs, focusing especially on high investment areas such as agricultural mechanics and other entrepreneurship SAEs. An assessment approach that includes knowledge learned and understandings developed, assessment of value to students' continuing education, and a quantitative assessment of economic impact would be a well-rounded model. This approach would help programs compete for shrinking state and private funding resources.

References

- Alward, G. (2008). *Introduction to IMPLAN*. [Motion picture]. (Available from Minnesota IMPLAN Group, Inc. 1725 Tower Drive West Suite 140 Stillwater, MN 55082. http://implan.com/v3/index.php?option=com_content&view=article&id=147:introduction-to-implan&catid=109:version-3-videos&Itemid=184)
- Arik, M., & Nsiah (2004, June). *Measuring the economic value impact of Middle Tennessee State University*. Center Report - Business and Economic Research Center – Jennings A. Jones College of Business at Middle Tennessee State University.
- Blackwell, M., Cobb, S., & Weinberg, D. (2002). The economic impact of educational institutions: Issues and methodology. *Economic Development Quarterly*, 16, 88-95.
- Bryant, B. (2003). SAE: An important part of the curriculum. *The Agricultural Education Magazine*, 75(6), 5.
- Case, L. D., & Stewart, B. R. (1985). Teacher influence on the quality of supervised occupational experience. *The Journal of the American Association of Teacher Educators in Agriculture*, 26(2), 2-8.
- Cheek, J., Arrington L., Carter, S., & Randell, R. (1994). Relationship of supervised agricultural experience program participation and student achievement in agricultural education. *Journal of Agricultural Education*, 35(2), 1-5.
- Christiansen, J. E. (1999). Economic impact of supervised agricultural experience programs in Georgia: A critique. *Proceedings of the 26th National Agricultural Education Research Conference, Orlando, Florida*, 26, 157.
- Committee on Agricultural Education in Secondary Schools, National Research Council. (1988). *Understanding agriculture: New directions for education*. Washington, DC: The National Academies Press.
- Cole R. L., & Connell, D. P. (1993). The economic impact of Oregon agricultural science and technology programs. *Journal of Agricultural Education*, 34(1), 60-67
- Davis, J. A. (1971). *Elementary survey analysis*. Englewood, NJ: Prentice-Hall.
- Deyoe, G. P. (1953). *Farming programs in vocational agriculture*. Danville, IL: Interstate Printers and Publishers, Inc.
- Dillman, D. A. (2000). *Mail and Internet surveys: The tailored design method* (2nd ed.). New York: Wiley.
- Dyer, J. E., & Osborne, E. W. (1996). Developing a model for supervised agricultural experience program quality: A synthesis of research. *Journal of Agricultural Education*, 37(2), 24-33.
- Graham, J., & Birkenholz, R. (1999). Changes in Missouri SAE programs. *Proceedings of the 26th National Agricultural Education Research Conference, Orlando, Florida*, 26, 172-180.
- Kolb, David A. (1984.) *Experiential learning: Experience as the source of learning and development*. Englewood Cliffs, NJ: Prentice-Hall, Inc.
- Lindner, J., Murphy, T., & Briers, G. (2001). Handling nonresponse in social science research. *Journal of Agricultural Education*, 42(4), 43-53.
- Moore, G. E. (1988). The forgotten leader in agricultural education: Rufus W. Stimson. *The Journal of the American Association of Teacher Educators in Agriculture*, 29(3), 50-58.
- Moore, G. (2003). The sixteen theorems of SAE. *The Agricultural Education Magazine*, 75(6), 20-21.

- Mulkey, D., & Hodges, A. (2003). *Using Implan to assess local economic impacts*. Retrieved December 1, 2008, from <http://edis.ifas.ufl.edu/pdffiles/FE/FE16800.pdf>
- Newcomb, L. H., McCracken, J. D., Warmbrod, J. R., & Whittington, M. S. (2004). *Methods of teaching agriculture* (3rd ed.). Upper Saddle River, NJ: Pearson Education.
- Norton, F. (2004, January). *The economic impact of the University of New Mexico on the state of New Mexico*. Albuquerque: University of New Mexico, Bureau of Business and Economic Research.
- Retallick, M. S., & Martin, R. A. (2005). Economic impact of supervised agricultural experience in Iowa: A trend study. *Journal of Agricultural Education*, 46(1), 44-54.
- Roberts, T. G., & Harlin, J. F. (2007). The project method in agricultural education: Then and now. *Journal of Agricultural Education*, 48(3), 46-56.
- Shinn, G. C. (1987). September--The time to improve your laboratory teaching. *The Agricultural Education Magazine*, 68(3), 16-17.
- West, D., & Iverson, M. (1999). Economic impact of supervised agricultural experience programs in Georgia. *Proceedings of the 26th National Agricultural Education Research Conference, Orlando, Florida*, 26, 148-156.

Student Perceptions of Instructional Methods Towards Alternative Energy Education

Clayton W. Sallee, Dr. Don W. Edgar, Dr. Don M. Johnson, University of Arkansas

Abstract

The effectiveness of different methods of instruction has been discussed since the early years of formal education systems. Lecture has been deemed the most common method of presenting information to students and the demonstration method has been symbolized as the most effective tool developed for teaching. Engaging students is paramount to allowing instructors to expand student knowledge levels. The purpose of this study was to determine if the [state] Secondary Biodiesel Education Program ([state]SBEP) over alternative fuels had an effect towards student interest. It was found that there was a significant difference between student interest in method of presentation, $t(7) = 8.29, p < .05$. Furthermore, it was found a strong positive correlation ($r = .73$) between posttest scores and student tinkering self efficacy. Tinkering self efficacy was also found to be positively and significantly correlated with method of instruction. Through understanding perceptions held by student being taught through different methods, instructors can capitalize and further knowledge acquisition by students.

Introduction

Secondary students enrolled in today's agricultural science classrooms are inundated with information and have access to preferred methods of learning with available technology held. Teachers in today's setting must engage students actively through the instruction process in order to impact student learning. The problem solving method of instruction is a time-honored technique to present information to students in the agricultural science classroom (Flowers, J. & Osbourne, E.W. 1987; Osbourne, E.W. & Hamzah, R. 1989; Boone, H.N. & Newcomb, L.H. 1990). Through its wide use in school systems across the nation, methods employed towards agricultural students should be analyzed to understand their impact. Because students have identified diverse needs and ways of learning, research regarding methods of instruction for today's secondary professionals of education is extremely important.

It is perceived unlikely that agricultural science teachers are hired who lack the skills to effectively instruct students. Many teachers have been trained and certified to be experts in their respective fields. Congruently, there has been anecdotal evidence that teacher preparation and the ability to design instruction once engaged in the profession is a high concern for these individuals (Newcomb, McCracken, Warmbrod, & Whittington, 2004). Thus, the need to identify effective instructional techniques is imperative. Furthermore, it is noted by the researchers that this study will not answer the question of what is the best technique for all instances of teaching in agricultural science but the effects of teaching towards an identified topic which is gaining importance in today's society.

Most of the energy used presently comes from fossil fuels: petroleum, coal, and natural gas (Demirbas, 2007). Worldwide energy consumption has "increased 17 fold in the last century" (Demirbas, 2008, p. 177). In recent years there has been a concern of diminishing petroleum reserves and future energy supplies (Akbas & Ozgur, 2008; Vasudevan & Biggs,

2008). According to the Department of Energy's Annual Energy Review (2008), the world consumed 85.9 million barrels of petroleum per day with the United States consuming 20.6 million barrels per day in 2007, compared to 76.1 million barrels per day and 19.7 million barrels per day respectively in 2000.

Biodiesel is an efficient, renewable, biodegradable and 100 percent natural energy alternative to petroleum fuels (Akbas & Ozgur, 2008; Demirbas, 2008; Hunt, 2008; Vasudevan & Briggs, 2008). Biodiesel has many advantages over diesel including, lowered greenhouse gasses and is manufactured from renewable sources (Akbas & Ozgur, 2008; Demirbas, 2008; Hunt, 2008; Vasudevan & Briggs, 2008). According to the Department of Energy's Annual Energy Review (2008) carbon dioxide emission in the United States stood at 6 billion metric tons in 2007 which is 20 percent higher than in 1990. Therefore, biodiesel will be a valuable alternative to ultra-low sulfur diesel because of lower emissions properties (Demirbas, 2008).

Biodiesel production has been around since the invention of the diesel engine. Even though biodiesel had been around for over one hundred years, many of today's students do not know how it is produced. Adequate curriculum should be developed and presented to students in order to impact their learning. The question is therefore evoked, what is the best method for instructors to employ? "The earliest form of systematic curriculum building in vocational education may be attributed to Victor Della Vos" (Finch & Crunkilton, 1999, p. 5). Vos changed curriculum development from "conscious imitation" to "formal instruction in the mechanical arts" (Finch & Crunkilton, 1999, p. 5). Vos postulated that students would learn best through guided instruction. This new system of education adopted by many in the United States made students think and understand the process instead of just repeating unconsciously what had been told.

According to the National Research Agenda (2007), there is a need to "systematically identify and develop instructional systems to meet industry needs" (p. 19). Agricultural science programs should assess the needs of involved students and determine proficiencies needed through program completion. Acker (2008) stated that to achieve the 25x25 Renewable Energy Vision of expanding renewable energies, education of consumers must occur. There is a need for "renewable energy curriculum materials for secondary, middle, and primary schools" (Acker, 2008, p. 59). Teaching agriculture science students about alternative energies is new in secondary programs. Curriculum must be tested to ensure information is conveyed and retained in future energy consumers. As an emerging need in an economy devastated with reliance towards other countries, students in the United States should be educated about alternative solutions such as biofuel production, performance, and environmental effects.

Education results in realization leading towards acknowledgement of the impact of changes occurring in society and resulting effects on individuals involved. The education of people in all fields of renewable energies is vital to the growth and expansion of renewable energy. Furthermore, there is also a need for curriculum materials for students (Newcomb, et al., 2004; Acker, 2008). Through this adoption of ideology, the researchers have selected this topic for analysis towards methods of curriculum development and presentation.

Theoretical Framework

The purpose of teaching is to instill a desire to learn in students (Rogers & Freiberg, 1994), implant new ideas, and “dispose of or modify old ones” (Kolb, 1984, p. 28). The goal of teaching is to drive students to absorb everything seen, heard, or read about a topic (Rogers & Freiberg, 1994). Engaged students allow teachers to expand student knowledge. According to the National Research Agenda (2007) there is a need to “examine the value of experimental learning in enhancing academic achievement” (p. 19). Experimental learning could prove to be valuable in allowing students to gain knowledge and understand materials used in educational settings.

Lecture is the most common method of passing on information to students (Kindsvatter, Wilen, & Ishler, 1992; Waldron & Moore, 1991). According to Dewey (1938) traditional education is the study of facts and ideas that have occurred in the past. What is taught in the books is motionless, it has little thought about the ways an idea is created and does not think about the changes that will occur in the future (Dewey, 1938). Lecture method instruction is a one-way, teacher centered presentation of information and ideas (Kindsvatter et al., 1992; Waldron & Moore, 1991; Morrison et al., 2004). Lecture method instruction allows for large concepts and ideas to be communicated to the student in a relatively short period of time. This traditional method is caught up in the past and gives “little help in dealing with the issues of the present and future” (Dewey, 1938, p. 22-23). Most lectures deal with ideas that are already developed and give little opportunity for exploitation of new ideas.

“Demonstrations have served as one of the most effective education tools ever developed” (Seevers, Graham, Gamon, & Conklin, 1997, p. 145). According to Seevers et al., (1997) demonstrations limit the number of students engaging in the learning process and are one of the most effective teaching methods. The limitation of students allows for students involved in the educational process to take ownership in the project. Demonstrations are more personal to the student and allow interaction and knowledge acquisition to occur. According to Dewey (1938) demonstrations may have “more multiplied and more intimate contacts” between the instructor and the student than “ever exists” in lecture method education (p. 21). A demonstration allows students to see how something works or is used, operated, or performs (Kindsvatter et al., 1992; Phipps et al., 2008). Demonstrations also allow students to see and how to properly perform a task (Kindsvatter et al., 1992). The increased interaction of seeing how process and equipment operates allows students to gain greater insight into a process.

Experiential learning provides the student with a significant and meaningful learning experience (Rogers & Freiberg, 1994). According to Kolb (1984) experience plays a key role in the learning process. Experiential learning uses both thoughts and feeling to make a connection about what is being taught (Rogers & Freiberg, 1994). Kolb (1984, p. 27) also states that “knowledge is continuously derived from and tested out in the experiences of the learner”. Learning is a continuous process that is grounded in experience and is important in education (Kolb, 1984). This experience will give the learner the information about the subject that they will need and will give them ownership and participation in the learning process. According to Roberts (2006) experiential learning is a cyclical process that is reoccurring. The learner has to take part and have an active role in the educational process before there can be meaning in what is being taught. The final ideas of experiential learning are pervasiveness and evaluation of the event (Rogers & Freiberg, 1994). It is important that the learner look at what has been taught and

make a decision about the information. These ideas contribute to the meaning of the learning experience and the meaning is the whole experience (Rogers & Freiberg, 1994).

Tinkering self efficacy is a person's experience, competence, and comfort with manual activities (Baker & Krause, 2007). According to Baker and Krause (2007), tinkering self efficacy is more specifically one's ability to engage in activities such as manipulating, assembling, disassembling, constructing, modifying, breaking and repairing components and devices. In education tinkering is often encouraged because of its expected educational benefits (Rowe, 1978). According to Parsons (1995) there are many factors that contribute to a student's tinkering ability. The three most common factors are experimental, social, and personal. Experimental factors are prior experiences that a person has in their everyday life. Social factors are relations that people have with family and friends. The final factor in tinkering is personal, and can be described as a person's like or dislike to a subject, topic, and/or activity (Parsons, 1995).

According to Baker and Krause (2007) males have more tinkering experiences and females lack experience using tools and machinery. Male are more apt to tinker to solve problems but some of their tinkering to solve problem can be counterproductive (Beckwitk et al., 2006; Jones, Brader-Araje, Carboni, Carter, Rua, & Banilower, 2000). Furthermore, Crismond (2001) stated females in technical schools were more apprehensive of mechanical devices unlike their male counterparts and when tinkering in a complex environment female tinkering self efficacies was perceived to be lower (Beckwitk et al., 2006).

Different methods of instruction suit different individuals in different ways. Method of instruction is important because it helps develop the students' powers and interest (Dewey, 1938). Motivation is a key factor in student learning (Phipps et al., 2008) and is needed for students to gain the most out of instruction. It is extremely important to provide students with instructional methods they will find enjoyable and interesting. This is important because the mind is opposed to learning (Dewey, 1938), and if the method of instruction is not interesting the student will not attempt to acquire the information.

Methodology

The purpose of this study, which was part of a larger study, was to determine if the [state] Secondary Biodiesel Education Program ([state] SBEP) over alternative fuels had an effect towards student interest. It has been traditional to provide students with a lecture of important information and then provide the students with a method of reinforcement (Waldron & Moore, 1991). Different methods of instruction have different effects on student learning and interest in a subject area. This study evaluated students' interest in the two methods used to present the ([state] SBEP), lecture and demonstration. Additionally, this study also sought to find if knowledge acquisition was correlated to students' tinkering self efficacy.

This study was guided by the following research questions:

1. What are student perceptions of lecture versus demonstration methods in biofuel education?

2. Is students' tinkering self efficacy related to knowledge acquisition in biofuel education?
3. Is there a relationship between students tinkering self-efficacy and perceptions of lecture versus demonstration methods in biofuel education?

This study sought to address the following hypotheses:

Ho₁: There will be no significant difference in student interest of presentation method after completion of the [state] Secondary Biodiesel Education Program.

Ho₂: There will be no significant correlation in students tinkering self efficacy and posttest knowledge scores through biofuel education.

Ho₃: There will be no significant correlation between students tinkering self efficacy and method used through biofuel education.

This study conforms to the design as outlined by Campbell and Stanley (1963) as a pre-experimental design number two (Figure 1). This pre-experimental design is a modified One-Group Pretest-Posttest Design (Campbell & Stanley, 1963). Alpha level was set *a priori* at .05. An outline of this design is as follows:

One-Group Pretest-Posttest Design
O₁ X₁ X₂ O₂

Figure 1. Modified research design from Campbell and Stanley (1963).

According to Campbell and Stanley (1963) threats to internal validity for the one-group pretest-posttest design are history, maturation, testing, instrumentation, regression, and selection-maturation interaction. The threats of history and maturation were minimized in the study. The study was conducted over a relatively short amount of time (two days per class), and therefore, threats of internal validity were minimized. The threats of testing and instrumentation were also minimized. The subjects were provided with a pretest and a posttest following the educational program. Each test covered the same constructs but were reworded and reordered in the final administration. The instrument was pilot tested for internal consistency and stability.

This study used indirect inference to acquire subjects for this study. Target population was high school agriculture classes in the [state] ($N = 217$). The accessible population was all high school agriculture classes in a 40 mile radius of [university] ($n = 18$). The sample was further mitigated to include agricultural science programs engaged in instructing students in agricultural mechanics courses which limited the sample to the tested population of study. This identified population allowed researchers to analyze students with advanced knowledge of agricultural mechanical techniques. A sample was drawn of four schools and a total of eight classes were selected. Teachers of selected schools were contacted to determine interest in participating in the research study.

The instruments developed for this study were constructed from an intense literature review and measured the main constructs found in the curriculum of the ([state] SBEP) over alternative fuels. The instruments developed were reviewed by a committee of experts for face and content validity.

The pretest was composed of four sections. The first section was comprised of multiple choice questions with four response options (one correct response and three distracters). The second section was composed of seven Likert-type items (1-5 scale: strongly disagree to strongly agree) designed to measure student perceptions of biodiesel. The third section consisted of items (1-5 Likert-type scale: strongly disagree to strongly agree) assessing students' tinkering self efficacy. The final section contained seven questions covering basic demographic questions.

The posttest comprised three sections. The first section consisted of the same 18 multiple choice items as the pretest instrument but were rearranged and reworded. The second section contained the same items measuring student's perceptions about biodiesel. The final section was comprised of seven questions about their perceptions about the educational presentation, measured on a 1-5 Likert-type scale (strongly disagree to strongly agree).

All instruments, materials and instructional methods were pilot-tested using 15 secondary students similar to the subjects in the main study. Minor revisions were made based on the pilot-test. Cronbach coefficient alpha and KR-21 analyses were run on instrument sections. The pretest question relating to knowledge had a KR-21 score of .13 (see Table 1). This analysis signified that knowledge held by participants before implementation of the ([state] SBEP) is the result of no or little knowledge about the subject matter and is attributed to guessing. Conversely, the posttest questions relating to knowledge held a KR-21 of .76.

Table 1

Instrument Reliability Analyses

Test section	Cronbach Alpha	KR-21	N
Pretest Knowledge		.13	91
Posttest Knowledge		.76	91
Pretest Tinkering	.89		88
Pretest Perceptions	.90		88
Posttest Perceptions	.93		88
Posttest Teaching Method	.76		88

All subjects in the study were contacted by a permission letter, sent out through their regular instructor, whereby they and a legal guardian were required to sign before participation. The first day of the educational program consisted of a lecture over alternative fuels. The lecture covered five main constructs. The first construct was differences in biodiesel and ethanol. The second construct was history of biodiesel, followed by how biodiesel is manufactured. The final three constructs were ASTM D6751 guidelines, blending capabilities with petroleum diesel, and emission characteristics of biodiesel.

The following day subjects were provided a demonstration of the performance differences between D2 diesel and B20 biodiesel. Before the demonstration, safety precautions were outlined about the project. The demonstration utilized a three cylinder Kubota diesel engine mounted on a trailer (see Figure 2). The engine was outfitted with a *Land and Sea* dynamometer to record horsepower and torque. Data were collected with a laptop computer with appropriate

software. Fuel consumption was measured using two portable digital scales. Subjects were given a five minute PowerPoint© presentation over the engine and what data would be collected. Furthermore, the PowerPoint© presentation covered how horsepower, torque, and fuel consumption was collected.



Figure 2. Mobile biodiesel demonstration unit used in ([state]SBEP).

Procedures of the demonstration were that the engine was set to operate on diesel fuel and started. The subjects recorded torque and horsepower at idle speed of the engine. The engine RPM was increased to high idle and the subjects recorded horsepower and torque. Load was added to the engine through the engine dynamometer. Once the engine reached pre-designated RPMs, subjects recorded both the horsepower and torque (sweep test). This procedure was repeated in both the D2 diesel and B20 biodiesel. Additional information was gathered from fuel consumption of both fuel types to calculate power and efficiency. The subjects then returned to class where they calculated the fuel consumption and graphed torque and horsepower for the D2 diesel and the B20 biodiesel. Torque and horsepower was exported to Microsoft Excel©. Graphs were made of torque and horsepower between the different fuels.

Data collected in this study were analyzed using descriptive and inferential statistics. Class was used as the unit of analysis because instruction was provided on a whole class basis. Descriptive statistics were also reported on participants to further disaggregate data.

Findings

By class, pretest knowledge scores ranged from 4.15 (23.1%) to 6.20 (34.4%) on the 18 item test. Mean scores for the pretest 18 question knowledge section were 5.12, 4.15, 4.55, 5.60, 5.75, 6.11, 5.62, and 6.20 respectively (see Table 2). The theoretically derived means for all class was 4.5. The percentage of pretest scores did not differ from the theoretically derived mean of guessing, $\chi^2 (7, N = 91) = 2.24, p > .94$.

Table 2

Pretest Knowledge Chi Squared

Class	Observed Mean*	Theoretically Derived Mean	χ^2	<i>p</i>
1	5.12	4.5	2.33	.94
2	4.15	4.5		
3	4.55	4.5		
4	5.60	4.5		
5	5.75	4.5		
6	6.11	4.5		
7	5.62	4.5		
8	6.20	4.5		

*Note. Maximum score = 18, $\chi^2(7) = 14.07$

There were 91 students that participated in the study; some data sets will describe a smaller size due to unusable data. For all classrooms in the study, 91.56 percent of the students in the study were male and 8.44 percent of the students were female. The mean age for all students in the study was approximately 17 ($M = 16.92$, $SD = .95$) with a range of 15-20. The mean grade for all students in the study was 11th ($M = 10.95$, $SD = .66$) with a range of 10th through 12th grade. The majority of the students ($n = 32$, 36.78%) were in the 11th grade, closely followed by 10th graders ($n = 31$, 35.63%). The mean self-reported grade attained in regular academic classrooms was a “B” ($M = 2.40$, $SD = .91$) with a range from an “A” to a “D”. Grades in agricultural classes was an “A” ($M = 1.65$, $SD = .88$) with a range from an “A” to a “D”.

Null Hypothesis One

Null hypothesis one stated there would be no significant difference in student interest over alternative fuels after instruction over alternative fuels in secondary agricultural classes. The hypothesis was tested using a dependent *t*-test. Data indicated a significant difference between student interest in method of presentation, $t(7) = 8.29$, $p < .0001$. Based on these findings, null hypothesis one was rejected.

The lecture contained a mean score of 3.17 ($SD = 1.47$), with a range from one to five (see Table 3). Mean scores for classes 1 through 8 on student interest in the lecture was 3.25 ($SD = 1.39$), 3.05 ($SD = 1.41$), 3.56 ($SD = 1.62$), 2.80 ($SD = 1.44$), 3.42 ($SD = 1.22$), 2.96 ($SD = 1.58$), 2.83 ($SD = 1.66$), and 3.48 ($SD = 1.42$), respectively. The demonstration contained a mean score of 4.25 ($SD = 1.07$), with a range from one to five. Mean scores for classes 1 through 8 on student interest in the demonstration was 4.43 ($SD = .79$), 4.00 ($SD = 1.19$), 4.67 ($SD = .86$), 4.27 ($SD = 1.16$), 3.82 ($SD = 1.03$), 4.10 ($SD = 1.24$), 4.33 ($SD = 1.17$), and 4.36 ($SD = 1.13$), respectively.

Table 3

Student Perception of Teaching Method (N = 83)

Class	Lecture		Demonstration	
	<i>M</i> *	<i>SD</i>	<i>M</i> *	<i>SD</i>
1	3.25	1.39	4.43	.79
2	3.05	1.41	4.00	1.19
3	3.56	1.62	4.67	.86
4	2.80	1.44	4.27	1.16
5	3.42	1.22	3.82	1.03
6	2.96	1.58	4.10	1.24
7	2.83	1.66	4.33	1.17
8	3.48	1.42	4.36	1.13
Total	3.17	1.47	4.25	1.07

* *Note.* Mean (1 = Strongly Disagree, 2 = Disagree, 3 = Neutral, 4 = Agree, 5 = Strongly Agree).

Null Hypothesis Two

Null hypothesis two stated no significant correlation between students tinkering self-efficacy and posttest scores would exist. Table 4 presents the correlation between posttest scores and students tinkering self efficacy scores ($N=91$). There was a strong positive correlation of .73 between posttest scores and student tinkering self efficacy.

Table 4

Correlations between posttest scores and tinkering self efficacy (N = 91)

Subscale	1	2
Posttest Score (1)	1	.73*
Tinkering Self Efficacy (2)		1.00

**Note.* $p < .05$; $r^2 = .53$

For all classrooms in the study, 84 subjects were described in students tinkering self efficacy (see Table 5). Tinkering self efficacy score was 4.08 ($SD = .77$), with a range from one to five. Mean tinkering self efficacy scores for classes 1 through 8 on the pretest were 4.55 ($SD = .63$), 3.84 ($SD = 1.18$), 4.03 ($SD = 1.18$), 3.66 ($SD = .41$), 3.94 ($SD = .85$), 3.65 ($SD = 1.12$), 4.63 ($SD = .20$), and 4.31 ($SD = .55$), respectively.

Table 5

Tinkering self efficacy scores in relation to class

Class	<i>n</i>	<i>P</i>	<i>M</i> *	<i>SD</i>
1	7	8.33	4.55	.63
2	11	13.10	3.84	1.18

Table 5 cont.

Class	<i>n</i>	<i>P</i>	<i>M</i> *	<i>SD</i>
3	9	10.71	4.03	1.18
4	5	5.95	3.66	.41
5	15	17.86	3.94	.85
6	15	17.86	3.65	1.12
7	7	8.33	4.63	.20
8	15	17.86	4.31	.55
Total	84	100.00	4.08	.77

* *Note.* Mean (1 = Strongly Disagree, 2 = Disagree, 3 = Neutral, 4 = Agree, 5 = Strongly Agree).

Null Hypothesis Three

Null hypothesis three stated that no significant correlation between students tinkering self efficacy and method used through biofuel education. Data were analyzed through Pearson Product Moment correlations and *t* test analyses. A significant positive moderate correlation (Davis, 1971) was found (Table 6) between the two methods of instruction (PowerPoint© and Demonstration). Further analysis based on this finding showed a significant *t* value based on students' tinkering self efficacy and the demonstration method (see Table 7). Analysis of the upper and lower quartile of participants with respect to tinkering self efficacy and method of instruction revealed $t(41) = -2.58$ and $p = .01$. Effect size was calculated at $d = .80$ describing a large effect size (Cohen, 1988). Null hypothesis three was rejected.

Table 6

Correlations between tinkering self efficacy and methods of instruction

Subscale	1	2	3
Tinkering (1)	1	.03	.19
PowerPoint© (2)		1.00	.42*
Demonstration (3)			1.00

**Note.* Value significant at the .05 level

Table 7

Tinkering self efficacy influence on perceptions of method of instruction

	<u>Upper Quartile</u>		<u>Lower Quartile</u>		<i>t</i> value	<i>p</i>
	<i>M</i>	<i>SD</i>	<i>M</i>	<i>SD</i>		
PowerPoint©	3.48	1.12	2.98	1.07	-1.50	.14
Demonstration	4.85	.53	4.37	.89	-2.58	.01*

**Note.* Significant at $p < .05$

Conclusions, Recommendations & Discussion

The majority of subjects in the study were males (91.56%), with an age of 17 ($M=16.92$), 11th grade students who made “B’s” in all secondary classes and “A’s” in agricultural classes. Through analysis conducted in this study, it is apparent that correct knowledge held by participants about biofuel is negligible. Pretest knowledge were calculated at $M = 5.39$. The theoretically derived pretest mean score for all classes were 4.50. The percentage of pretest scores did not differ from the theoretically derived mean of guessing (Table 2). Data indicated knowledge held is low thus demonstrating the need for education about biofuel (Acker, 2008). Furthermore, posttest knowledge score held an $M = 10.36$. The implementation of the [state] Secondary Biodiesel Education Program (ASBEP). indicated statistically significant gain in knowledge scores after the two day educational program. Though not a statistically significant increase in knowledge held by participants, it can be concluded that participants did gain in knowledge based on the implementation of the [state] Secondary Biodiesel Education Program.

To further demonstrate the basis of the study, participants were measured based on their interest towards presentation method of the ([state] SBEP). Findings concluded ($t(7) = 8.29, p < .0001$) a significant difference held by students towards their preferred method of presentation. Therefore, it is concluded that presentation methods used by instructors can significantly affect student interest in subject matter (Dewey, 1938; Kinsvatter et al., 1992; Severs et al., 1997). The use of the demonstration method gained student interest over the use of the lecture method in all participant classes involved in the ([state] SBEP).

Additional data was gathered to explore interest held in agricultural mechanization areas of agricultural science instruction by participants. To determine the basis for this question, knowledge about student tinkering self efficacy were analyzed. It was found that students ($N = 91$) who held a positive tinkering self-efficacy score were positively correlated to post-test scores ($r = .73$) through the ([state] SBEP). Based on the demographics of the sample (males = 91.56%), a large proportion of the sample should hold a positive tinkering self-efficacy (Beckwitk, et al., 2006; Jones et al., 2000) which this study agrees with previous aforementioned studies. Although not inclusive that all males hold this quality, it should be noted that tendencies for males to hold tinkering self efficacy should be addressed when determining best practices towards methods of teaching in classes including large numbers of male students. Based on the high value of the Pearson Correlation Coefficient ($r = .73$) and common variance held ($r^2 = .53$) in this statistical procedure (only 47% of extraneous variance unexplained) teachers should consider this finding when teaching based on factors noted in this study.

Congruent with Dewey’s (1938) view of learning and the findings of this study, students gained interest resulting in acquisition of knowledge in a subject area with little to no previous experience. Through the implementation of the ([state] SBEP) and differentiated teaching methods, students were able to understand unfamiliar subject matter and increase their understanding thus corroborating with (Kinsvatter et al., 1992) that demonstrations allow students to view and understand a properly performed task. Gaining insight(s) of processes through the interaction of the demonstration method teaching technique between students and instructors, it is concluded this method positively affected participants of this study.

Findings of this study revealed that students tinkering self efficacy positively affected their perceptions towards method of instruction. Students with high tinkering self efficacy preferred the use of a demonstration method in the context of this study. This finding supports previous research (Kindsvatter et al., 1992) concluding that demonstrations allow students to better view and process skills associated with performing a task. It is concluded that students tinkering self efficacy does have a significant correlation between methods used to educate students about biofuel in this study. Furthermore, it should be noted that students having a higher self perceived ability towards tinkering self efficacy prefer methods of instruction towards biofuel education when taught via the demonstration method. Impacting knowledge through laboratory exercises is a main stay in agricultural science education through the problem solving method (Flowers, J. et al., 1987; Osbourne, E.W. et al., 1989; Boone, H.N. et al., 1990). Through knowledge gained about student tinkering self efficacy, professional educators can choose methods of instruction aligning with preferred methods of students who are more inclined to possess high tinkering ability.

Recommendations based on the findings of this study include using the demonstration methods when presenting material when deemed appropriate to gain student interest. This recommendation is further refined to include areas of study when classroom participants are heavily weighted towards male percentages based on their tinkering self efficacy preferences. Furthermore, understanding of the interest gained through the demonstration method will allow instructors to capitalize and further knowledge acquisition. Additional research should be undertaken to determine tinkering self efficacy and its result in cognitive processing of complex tasks undertaken in laboratory settings. This study should be replicated in demographically diverse areas (male and female populations more congruent with state/national norms) and in other states to determine its relevance in other settings.

The researchers further recommend that investigation into the effects of student interest and tinkering self efficacy should be studied in other educational content areas to discover if these findings are similar based solely on method or differences exist based on the content area. Based on the findings of this study, demonstrations are a preferred method of instruction for students possessing a high level of tinkering efficacy the relationship (if it exists) should be investigated in other settings commonly seen in secondary settings such as biology, chemistry, and physics to illustrate a few.

References

- Acker, D. (2008). Research and education priorities in agriculture, forestry and energy to achieve the 25x25 renewable energy vision. *North American College Teachers Association*, 52(1) 55-59.
- Akbas, C. Y., & Ozgur, E. (2008). Biodiesel: An alternative fuel in EU and Turkey. *Energy Sources, Part B: Economics, Planning, and Policy*, 3(3), 243-250.
- Baker, D., & Krause, S. (2007). How well do tinkering and technical activities connect engineering education standards with the engineering profession in today's world? *Proceedings of the 2007 ASEE Annual Conference & Exposition American Society for Engineering Education*, Honolulu, HI.
- Beckwith, C., Kissinger, C., Burnett, M., Wiedenbeck, S., Lawrance, T., Blackwell, A., & Cook, C. (2006). Tinkering and gender in end-user programmers' debugging. *Conference on Human Factors in Computing Systems (pp. 231 – 240)* Montréal, Québec, Canada: Publisher AMC.
- Boone, H.N. & Newcomb, L.H. (1990). Effects of approach to teaching on student achievement, retention and attitude. *Journal of Agricultural Education*, 29(4) 9-14.
- Campbell, D. T. & Stanley, J. C. (1963). *Experimental and quasi experimental designs for research*. Chicago: Rand McNally.
- Cohen, J. (1988). *Statistical power analysis for behavioral sciences* (2nd ed.). Hillsdale, NJ: Erlbaum Associates.
- Crismond, D. (2001). Learning and using science ideas when doing investigate-and- redesign tasks: A study of naive, novice, and expert designers doing constrained and scaffolded design work. *Journal of Research in Science Teaching*, 38, 791-820.
- Demirbas, A. (2007). Alternatives to petroleum diesel fuel. *Energy Sources, Part B: Economics, Planning, and Policy*, 2(4), 343-351.
- Demirbas, A. (2008). The importance of bioethanol and biodiesel from biomass. *Energy Sources, Part B: Economics, Planning, and Policy*, 3(2), 177-185.
- Dewey, J. (1938). *Experience & Education*. New York, New York: Touchstone.
- Finch, C. R. & Crunkilton, J. R. (1999). *Curriculum development in vocational and technical education: Planning, content, and implementation*. Needham Heights, MA: Allyn & Bacon.

- Flowers, J. & Osbourne, E.W. (1987). The problem solving and subject matter approaches to teaching vocational agriculture: Effects on student achievement and retention. *Journal of Agricultural Education*, 29(1) 20-26, 52.
- Hoydonchx, H. E., De Vos, D. E., Chavan, S. A., & Jacobs, P. A. (2004). Esterification and transesterification of renewable chemicals. *Topics in Catalysis*, 27(1-4), 83-96.
- Hunt, S. (2008). Biofuels, neither saviour nor scam: The case for a selective strategy. *World Policy Journal*, 25(1), 9-17.
- Jones, M. G., Brader-Araje, L., Carboni, L. W., Carter, G., Rua, M. J., & Banilower, E. (2000). Tool time: Gender and students' use of tools, control, and authority. *Journal of Research in Science Teaching*, 37(8), 760-783.
- Kolb, D. A. (1984). *Experiential learning: Experience as the source of learning and development*. Englewood Cliffs, New Jersey: Prentice-Hall, Inc.
- Kindsvatter, R., Wilen, W., & Ishler, M. (1992). *Dynamics of effective teaching* (2nd ed). White Plains, New York: Longman Publishing Group.
- Newcomb, L.H., McCracken, J.D., Warmbrod, J.R., & Whittington, M.S. (2004). *Methods of teaching agriculture* (3rd ed). Upper Saddle River, New Jersey: Pearson Education, Inc.
- Parsons, S. (1995). Making sense of students' science: The construction of a model of tinkering. *Research in Science Education*, 25(2), 203-219.
- Osbourne, E.W. & Hamzah, R. (1989). Use of problem solving teaching among secondary agriculture teachers in Illinois. *Journal of Agricultural Education*, 30(3) 29-36.
- Phipps, L. J., Osborne, E. W., Dyer, J., & Ball, A. (2008). *Handbook on agricultural education in public schools* (6th ed.). Clifton Park, New York: Thomas Delmar Learning.
- Roberts, T. G. (2006). A philosophical examination of experiential learning theory for agricultural educators. *Journal of Agricultural Education*, 47(1), 17-29.
- Rogers, C., & Freiberg, H. J. (1994). *Freedom to learn* (3rd ed). New York, New York: Macmillan College Publishing Company.
- Seevers, B., Graham, D., Gamon, J., & Conklin, N. (1997). *Education through cooperative extension*. Albany, New York: Delmar Publishers.
- U. S. Department of Energy. (2009). *Annual Energy Review 2008* (DOE/EIA-0384(2008)). Washington, DC.
- Vasudevan, P. T. & Briggs, M. (2008). Biodiesel production: Current state of the art and challenges. *Journal of Industrial Microbiology and Biotechnology*, 35(5), 421-430.

Waldron, M. W., & Moore, G. A. B. (1991). *Helping adults learn: Course planning for adult learners*. Toronto, Ontario: Thompson Educational Publishing, Inc.

Teachers' Use of Agricultural Laboratories in Secondary Agricultural Education

Catherine W. Shoulders, Dr. Brian E. Myers, Oklahoma State University

Abstract

Trends in the agriculture industry require students to have the ability to solve problems associated with scientific content. Agricultural laboratories are considered a main component of secondary agricultural education, and are well suited to provide students with opportunities to develop problem-solving skills through experiential learning. This study serves to examine the current availability and use of agricultural laboratories in secondary agricultural education, as well as their relationship to teacher perceptions regarding student learning, preparation requirements, and barriers to using their use. Findings indicate that while many facilities are available and frequently used during instruction, teacher perceptions of student learning, preparation requirements, and barriers vary by facility.

Introduction/Theoretical Framework

Agricultural industry trends signal a need for agricultural education to teach scientific problem solving, spurring the USDA to recommend that students seeking future employment in the agricultural industry have “basic science skills and the ability to solve problems with scientific applications” (USDA, 2005, p. 12). With the widespread assumption of secondary agriculture teachers making use of agricultural laboratories (Franklin, 2008; McCormick, 1994; Newcomb, McCracken, Warmbrod, & Whittington, 2004; Phipps, Osborne, Dyer, & Ball, 2008), those concerned with the improvement of science understanding through applied learning should have reason to be optimistic. By its very nature, agricultural education is in an ideal position to teach scientific content through an agricultural context (Enderlin & Osborne, 1992; NRC, 2009; Thompson, 1998; Washburn & Myers, 2008). However, many of the activities designed for use in agricultural laboratories focus solely on the improvement of psychomotor skills rather than the reinforcement of academics (Franklin, 2008; Johnson, Wardlow, & Franklin, 1997).

Agricultural laboratories, which can include mechanics laboratories, greenhouses, livestock facilities, land laboratories, and aquaculture laboratories, among others, are currently understood as a means for providing students practice in application of theories taught in the classroom (McCormick, 1994); however, the emergence of scientific agricultural education may provide opportunity for these laboratories to become a keystone in the teaching of scientific skills and problem solving. By designing laboratory instruction to focus on scientific problem solving, teachers can enhance student experiences to better prepare them for scientifically-based careers in agriculture (Parr & Edwards, 2004). However, little research has been conducted on the current use of agricultural laboratories. The Agricultural Education and Communication National Research Agenda identifies the determination of the relationship between instructional strategies and student achievement as a top priority initiative in order to increase the value of agricultural education on student achievement in science (National Research Agenda, 2007). This study serves to address this priority initiative by investigating how teachers' access to and current use of agricultural laboratories may be associated with their perceptions of student learning, teacher preparation, and teaching barriers. Further, this study serves as a starting point for an exploration

into the value of one of the cornerstone components of agricultural education and its utility in improving student achievement in scientific problem solving through experiential learning. Only after researchers have a grasp on the current uses of agricultural laboratories can they develop and evaluate strategies that may enhance student learning in these areas.

The utilization of laboratories to increase scientific problem solving skills is directly tied to the theory of experiential learning. Experiential learning combines the aspects of experience, perception, cognition, and behavior (Kolb, 1984) to allow students to apply knowledge and practice in real situations while modeling appropriate behaviors and procedures (Randell, Arrington, & Cheek, 1993). Specific dimensions of experiential learning include a concrete experience to be had by learners, active experimentation, reflection, observational learning, abstract conceptualization, risk and responsibility, and the role of the teacher as a facilitator (Knobloch, 2003). Agricultural laboratories are ideal settings for experiential learning, as they allow student involvement in learning to be “direct and purposeful, addressing a real world problem in a natural setting” (Zurbrick, 1990, p. 3). In order to effectively enhance the experiential learning of students in laboratory settings, teachers must prepare to take on a facilitator role and design instruction to focus on problem solving in real world contexts (Arnold, Warner, & Osborne, 2006). Agriculture teachers have previously identified learning enhancement, including the use of higher order thinking skills and subject matter retention, as a benefit of experiential learning (Arnold, Warner, & Osborne, 2006). These benefits, however, do not occur without teacher change. Arnold, Warner, and Osborne (2006) found that modifications in teaching style, along with class enrollment challenges, time restraints, more complex supervision and management of student activities were all reported by agriculture teachers as barriers to utilizing experiential learning in the classroom.

Laboratory settings have long been an integral component of agricultural education, and remain a crucial aspect today (Phipps, Osborne, Dyer, & Ball, 2008). The skills developed through the appropriate use of agricultural laboratories (Figure 1) are diverse, yet relate directly to theories and concepts focused on in the classroom.

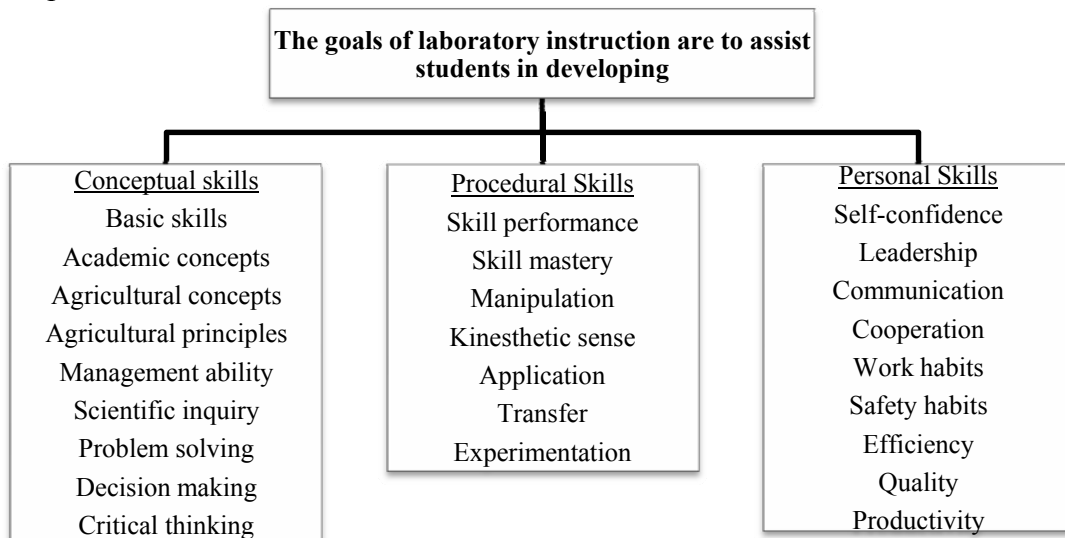

Figure 1. Goals of laboratory instruction (Phipps, Osborne, Dyer, & Ball, 2008).

While these theoretical goals are far reaching and include scientific inquiry and problem solving, traditional agricultural education instructional strategies utilize laboratories to focus primarily on

development of students' psychomotor skills necessary for traditional production agriculture occupations (Broyles, 2004; Johnson, 1989).

The development of instructional strategies to enhance the use of scientific inquiry and problem solving in agricultural laboratories requires an understanding of the laboratories available to teachers. Studies investigating the laboratories currently utilized in schools are few in number, and often regional. Young and Edwards (2005) identified the laboratory facilities available at 47 selected Oklahoma secondary agricultural education programs, which included agricultural mechanics laboratories, feeding facilities, greenhouses, land laboratories, horticulture facilities, and aquaculture laboratories. From a sample of Arizona agriculture teachers, Franklin (2008) reported that 76% had a greenhouse facility and 28.8% had a plant nursery. Because agriculture is regionally distinct, a larger study incorporating different regions could provide a more accurate picture of agricultural laboratories prevalent across the nation.

Research has identified barriers to utilizing laboratories which may compound the issue of incorporating strategies to enhance scientific inquiry and problem solving. Situated barriers such as teacher competency in laboratories and maintaining discipline procedures during laboratory activities may attribute to a decrease in impact of laboratory use on content mastery (Franklin, 2008; Luiselli, Putnam, Handler, & Feinberg, 2005; Myers, Dyer, & Washburn, 2005).

Purpose and Objectives

The purpose of this study is to determine possible factors influencing secondary agriculture teachers' use of agricultural laboratories when instructing students. In order to address the above purpose, the following objectives were developed:

1. Identify the agricultural laboratories available to secondary agriculture teachers.
2. Identify the frequency with which agricultural laboratories are utilized in secondary agricultural education.
3. Determine the relationship between demographic factors and the frequency with which agriculture teachers utilize agricultural laboratories during instruction.
4. Determine the association between the frequency with which agriculture teachers utilize laboratories during instruction and their perceptions regarding barriers to their use, the level of preparation laboratories require, and laboratories' effect on learning.

Methods

This study utilized a nonexperimental descriptive survey design to gather data regarding agriculture teachers' use of agricultural laboratories.

Participants

The population consists of all secondary agricultural education teachers in the United States. This population was chosen because of their use of experiential learning in agricultural laboratories to teach agricultural theories and practices. The sampling frame consists of all members of the National Association of Agricultural Educators (NAAE), the national professional organization of secondary agricultural educators, and was selected because it contains the largest, most current database of contact information for the population ($N = 6311$). NAAE members that were not listed as agriculture teachers were removed from the sampling frame for the purposes of this study. From the sampling frame, a simple random sample was

drawn in order to ensure that all members had the same probability of being chosen. A random number generator, supplied by SPSS, was utilized. To complete the objectives, an email including a questionnaire invitation, designed for specific use in this study, was sent to the target sample of NAAE members ($n = 530$). This sample size was selected based on the population size, a 5% level of precision, and 95% confidence interval (Israel, 2009). The sample size was then increased by 20% to account for inaccurate or missing contact information and sample members who were no longer teaching.

According to Dillman, Smyth and Christian (2009), the most effective method of increasing participation rate on internet surveys is multiple contacts. Because little research has been performed regarding the optimal combination of contacts, the number of contacts after the initial invitation is left up to the researcher (Dillman, Smyth & Christian). However, Dillman, Smyth, and Christian recommend that when response rate per reminder email stalls, the researcher ceases sending reminders. Therefore, the researchers sent six emails to each member of the sample, including a prenotice email, the first email containing a link to complete the questionnaire and four reminder/thank you emails, also containing the questionnaire link.

Upon completion of data collection, six teachers from the sample were removed by request and 122 teachers were removed from the study due to inaccurate or missing contact information, leading to a total response rate of 51.1% ($n = 206$). Twelve respondents with crucially incomplete submissions were also removed, leading to a usable response rate of 48.1% ($n = 194$). With regard to the population studied, a response rate of less than 50% has been deemed acceptable in publications of similar nature (Lindner, Murphy, & Briers, 2001). Nonresponse error was addressed through a comparison of early to late respondents, as is common in agricultural education research. No significant differences were found between early and late respondents; therefore, results of this study are able to be generalized to the target population (Lindner, Murphy, & Briers, 2001; Miller & Smith, 1983).

The demographics collected in this study are displayed in Table 1. The respondent gender ratio is representative of the population (Camp, Broyles, & Skelton, 2002). Forty-five states were represented in the data; however, 4.6% ($n = 9$) did not supply their state. Respondents also displayed a wide range of teaching experience, with 5.2% ($n = 10$) not supplying their length of teaching experience. Over half of the respondents were students of secondary agricultural education for four years ($n = 106$); however, 5.2% ($n = 10$) did not supply their length of time as a secondary agricultural education student. The majority of respondents teach at schools in rural settings; however, 4.6% ($n = 9$) did not supply their school setting.

Table 1
Demographic Data of Respondents

Demographic	<i>n</i>	<i>%</i>
<u>Gender</u>		
Male	137	70.6
Female	57	29.4
<u>Years of Teaching Experience</u>		
1-5	37	19.1
6-10	39	20.1

11-15	31	16.0
16-20	15	7.7
21-25	24	12.4
26-30	24	12.4
31-35	11	5.7
36-40	3	1.5
<u>Years as an Secondary Agriculture Student</u>		
0	23	11.9
1	3	1.5
2	7	3.6
3	21	10.8
4	106	54.6
5	15	7.7
6	9	4.6
<u>School Setting</u>		
Urban	19	10.0
Suburban	31	16.0
Rural	135	69.6

Limitations of this study stem from the sampling frame utilized. While the population includes all secondary agricultural education teachers in the United States, the largest available database of contact information on this population was obtained from the most recent list of NAAE members. However, not all members of the population are NAAE members, and the NAAE member database lacks complete accuracy due to teachers retiring, moving schools, or having inaccurate emails on record. Therefore, the main limitation of this study is that not all members of the population had an equal opportunity to be included in the sampling frame. Further, this study assumes that all responses are made in a truthful manner, and lack falsities based on social desirability.

Instrument

The instrument utilized in this study was based on previous research focusing on perceptions of secondary agriculture teachers, and was selected for use after an extensive search for appropriate instrumentation (Layfield, Minor, & Waldvogel, 2001; Myers & Washburn, 2008; Thompson & Balschweid, 1999; Thompson & Schumacher, 1998). Items were modified slightly to meet the objectives of this particular study, and two additional items were added to meet the study's first objective. Items measured teacher perceptions of agricultural laboratories on a five-point rating scale. Perceptions were grouped into three constructs that separated teachers' perceptions of the effect of using laboratories on student learning, the level of preparation required when using laboratories, and the intensity of barriers when using laboratories. The authors of the original instrument reported Cronbach's alpha as a measure of internal validity of .88. Reliability was calculated *ex post facto* for each of the perceptive constructs utilized in this study, including perceptions of preparation required when utilizing agricultural laboratories ($\alpha = .72$), perceptions of effects of agricultural laboratory usage on student learning ($\alpha = .71$), and perceptions of barriers to utilizing agricultural laboratories ($\alpha = .90$).

Data Analysis

Data were analyzed using descriptive and correlational methods. Data were coded to be analyzed in SPSS, using either Pearson's correlation coefficient or Spearman's rho where appropriate to determine the magnitude of relationships sought from the objectives of the study. Magnitude was determined using Davis's convention (1971). According to Davis, relationships between .01 and .09 are negligible, those between .10 and .29 are low, those between .30 and .49 are moderate, those between .50 and .69 are substantial, and those over .70 are very strong.

Results

Availability of Laboratories

Objective 1 seeks to identify the agricultural laboratories available to secondary teachers (Table 2). The majority of respondents have access to a greenhouse (72.2%, $n = 140$) and a mechanics/carpentry/welding facility (76.8%, $n = 149$). Approximately half of the respondents have access to a landscaping area (51.1%, $n = 99$). Aquaculture tanks/ponds, biotechnology/science laboratories, field crops, forestry plots, gardens, and livestock/equine facilities are accessible by between 20% and 40% of the respondents. The two least available laboratories are the apiary (1.0%, $n = 2$) and the vineyard (0.5%, $n = 1$).

Table 2
Available Laboratories Identified by Respondents

Laboratory	<i>f</i>	%
Apiary	2	1.0
Aquaculture Tank/Pond	64	33.0
Biotechnology/Science Laboratory	43	22.2
Field Crops	52	26.9
Food Science Laboratory	22	11.3
Forestry Plot	43	22.2
Garden	75	38.7
Greenhouse	140	72.2
Landscaping Area	99	51.0
Livestock/Equine Facility	56	28.9
Meats Laboratory	8	4.1
Mechanics/Carpentry/Welding Facility	149	76.8
Nursery/Orchard/Grove	22	11.3
Small Animal/Veterinary Laboratory	18	9.3
Turf Grass Management Area	22	11.3
Vineyard	1	0.5

Frequency of Laboratory Use

The second objective sought to identify the frequency with which agricultural laboratories are utilized in secondary agricultural education (Table 3). Over half of teachers with access to an aquaculture tank/pond (57.8%), biotechnology/science laboratory (63.0%), food science laboratory (50.0%), garden (61.1%), greenhouse (90.6%), livestock/equine facility (69.7%), meats laboratory (62.5%), mechanics/carpentry/welding facility (90.6%), nursery/orchard/grove (68.1%), small animal/veterinary laboratory (94.4%), or turf grass management area (54.5%) reported utilizing the laboratory at least once per week. No teachers that had access to an apiary or vineyard reported using the laboratories at least once per week. However, both of these laboratories had very low numbers of teachers reporting to have access to the laboratory, as shown through Objective 1.

Table 3
Frequency of Agricultural Laboratory Use

Laboratory	<i>f</i>						
	Never	1x/ year	1x/ semester	1x/ month	1x/ week	1x/ day	>1x/ day
Apiary	0	0	2	0	0	0	0
Aquaculture Tank/Pond	2	6	9	10	17	14	6
Biotechnology/Science Laboratory	2	0	2	12	15	7	5
Field Crops	3	2	6	16	20	1	3
Food Science Laboratory	1	1	4	5	2	6	3
Forestry Plot	1	2	8	13	13	4	2
Garden	1	3	7	17	26	10	8
Greenhouse	1	0	5	7	28	58	40
Landscaping Area	2	3	13	30	34	10	3
Livestock/Equine Facility	1	1	8	7	11	14	14
Meats Laboratory	0	1	2	0	3	1	1
Mechanics/Carpentry/Welding Facility	3	2	1	8	13	50	72
Nursery/Orchard/Grove	1	2	1	3	10	3	2
Small Animal/Veterinary Laboratory	0	0	0	1	5	5	7
Turf Grass Management Area	0	1	4	5	8	3	1
Vineyard	0	0	0	1	0	0	0

The frequency of use of these laboratories provides the basis for measuring relationships in later objectives. Laboratories with low to very strong correlations are included in tables in discussion, while those with no and negligible correlations are omitted.

Relationship between Frequency of Use and Demographics

Objective 3 examined the relationship between teachers' frequency of use of laboratories and their demographics, including gender, years of teaching experience, school setting, and number of years as a secondary agriculture student. Correlations between frequency of laboratory use and gender are displayed in Table 4. Males were coded as 1 and females were coded as 0. A substantial negative correlation was found between gender and frequency of use of a meats laboratory ($r = -.66$). A moderate positive correlation was found between gender and frequency of use of the turf grass management area ($r = .30$).

Table 4

Correlations between Frequency of Use of Laboratories and Teacher Gender

Laboratory	<i>r</i>	Magnitude
Meats Laboratory	-.66	Substantial
Turf Grass Management Area	.30	Moderate
Biotechnology/Science Laboratory	.26	Low
Food Science Laboratory	.19	Low
Mechanics/Carpentry/Welding Facility	.17	Low
Landscaping Area	-.17	Low
Greenhouse	-.13	Low
Aquaculture Tank/Pond	.12	Low
Nursery/Orchard/Grove	-.10	Low

Note: female = 0; male = 1

Low, moderate, and very strong correlations were also found between frequency of use of specific laboratories and length of experience as an agriculture teacher. Frequency of use of the meats laboratory was found to have a very strong positive correlation to length of agriculture teaching experience ($r = .73$) while correlations between length of agriculture teaching experience and frequency of use of the biotechnology/science laboratory ($r = .17$), food science laboratory ($r = .22$), livestock/equine facility ($r = .25$), and nursery ($r = .21$) were found to be low and positive. A moderate negative correlation was found between length of agriculture teaching experience and frequency of use of the small animal/veterinary laboratory ($r = -.35$).

Moderate and low correlations were also found between frequency of use of specific laboratories and the number of years in which teachers were enrolled as secondary agriculture students, as shown in Table 5. A moderate positive correlation was found with regard to the nursery/orchard/grove ($r = .30$), while negative low correlations were found with regard to the garden ($r = -.11$) and the greenhouse ($r = -.19$)

Table 5

Correlations between Frequency of Specific Laboratory Use and Length of time Enrolled in Secondary Agricultural Education

Laboratory	<i>r</i>	Magnitude
Nursery/Orchard/Grove	.30	Moderate
Forestry Plot	.28	Low
Turf Grass Management Area	.21	Low
Aquaculture Tank/Pond	.19	Low
Greenhouse	-.19	Low
Food Science Laboratory	.15	Low
Livestock/Equine Facility	.13	Low
Meats Laboratory	.12	Low
Garden	-.11	Low

Lastly, correlations between school setting (defined as rural, suburban, and urban school settings) and frequency of specific laboratory use were found with several laboratories. Urban, suburban, and rural school settings were coded as 1, 2, and 3, respectively. Moderate negative

correlations were found between school setting and frequency of use of the food science laboratory ($r = -.43$), meats laboratory ($r = -.38$), biotechnology/science laboratory ($r = -.35$), landscaping area ($r = -.35$), nursery/orchard/grove ($r = -.33$), and livestock/equine facility ($r = -.30$). Low negative correlations were found between school setting and frequency of use of the garden ($r = -.19$), the small animal/veterinary laboratory ($r = -.15$), and the greenhouse ($r = -.13$). Only frequency of use of the turf grass management area was positively correlated with school setting ($r = .13$).

Relationship between Teacher Perceptions and Frequency of Laboratory Use

The final objective sought to determine the relationship between teachers' frequency of use of specific agricultural laboratories and perceptions regarding the use of agricultural laboratories' impact on student learning, preparation required to utilize laboratories during instruction, and barriers to utilizing agricultural laboratories during instruction (Table 6). Low positive correlations were found between teachers' perceptions of the impact of using agricultural laboratories during instruction on student learning and the frequency of use of eight of the laboratories. However, negative correlations were found between these same learning perceptions and frequency of use of three of the laboratories. Positive low correlations were found between teachers' perceptions of preparation requirements when using agricultural laboratories and the frequency of use of three of the laboratories. However, negative low correlations were found between these same preparation perceptions and frequency of use of four other laboratories. Lastly, the construct examining teachers' perceptions of barriers to using agricultural laboratories was found to have positive low correlations with the frequency of use of four of the agricultural laboratories and negative low correlations with three of the laboratories.

Table 6

Correlations between Perceptive Constructs and Frequency of Use of Laboratories

Relationship	<i>r</i>	Magnitude
Learning Perceptions and		
Meats Laboratory	-.51	Substantial
Small Animal/Veterinary Laboratory	-.38	Moderate
Food Science Laboratory	.23	Low
Garden	.23	Low
Greenhouse	.18	Low
Turf Grass Management Area	-.18	Low
Landscaping Area	.17	Low
Biotechnology/Science Laboratory	.16	Low
Aquaculture Tank/Pond	.14	Low
Mechanics/Carpentry/Welding Facility	.12	Low
Field Crops	.11	Low
Preparation Perceptions and		
Garden	.27	Low
Nursery/Orchard/Grove	-.24	Low
Small Animal/Veterinary Laboratory	-.20	Low
Greenhouse	.17	Low
Landscaping Area	.15	Low
Meats Laboratory	-.13	Low

Livestock/Equine Facility	-0.12	Low
Perceptions of Barriers and		
Biotechnology/Science Laboratory	.19	Low
Livestock/Equine Facility	.18	Low
Meats Laboratory	-0.18	Low
Forestry Plot	.15	Low
Nursery/Orchard/Grove	.13	Low
Aquaculture Tank/Pond	-0.13	Low
Food Science Laboratory	-0.13	Low

Conclusions

Availability of a wide variety of agricultural laboratories was found to be very common among secondary agricultural education programs. This is consistent with previous state-based research that indicated the presence of mechanics laboratories, livestock feeding facilities, greenhouses, land laboratories, horticulture facilities, and aquaculture laboratories in agricultural programs (Franklin, 2008; Young & Edwards, 2005). The least available agricultural laboratories included a vineyard and an apiary, which were not found to be common in any of the available research regarding agricultural laboratories. Over half the teachers reported utilizing the majority of their facilities more than once per week. These results support Phipps, Osborne, Dyer, and Ball's (2008) statements regarding the value of agricultural laboratories in agricultural education programs.

Females in this study tended to utilize the greenhouse, landscaping area, nursery/orchard/grove, and meats laboratory less than males, but tended to utilize turf grass management areas, biotechnology/science laboratories, food science laboratories, aquaculture tanks/ponds, and mechanics/carpentry/welding facilities more than males. Correlations indicate that 43.6% of the variance of frequency of use in of the meats laboratory and 9.2% of the variance of frequency of use in the turf grass management area were associated with gender. Gender was associated with the remaining correlated laboratories in lower amounts, ranging from 1.4% (aquaculture tank/pond) to 6.9% (biotechnology/science laboratory). Length of time enrolled as a secondary agriculture student was associated with between 1.5% and 9.0% of the variance in frequency of use of correlated laboratories. These results are supported by the theorized value of experiential learning in skill development (Beard & Wilson, 2006). Correlations were also found between school setting and frequency of use of ten of the laboratories. Teachers in more urban schools tended to use nine of the ten correlated laboratories more often, while teachers in more rural schools tended to utilize these laboratories less often. Variation in school setting was associated with variance percentages ranging from 1.7% (greenhouse) to 18.3% (food science laboratory).

Teachers using the food science laboratory, garden, greenhouse, landscaping area, biotechnology/science laboratory, aquaculture tank/pond, mechanics/carpentry/welding facility, and field crops more often tended to report more positive perceptions of student learning in laboratories, as has been reported by previous research (Arnold, Warner, & Osborne, 2006). However, negative correlations between perceptions of student learning and the turf grass management area, small animal/veterinary laboratory, and meats laboratory indicate that teachers using these laboratories more often tended to report more negative perceptions of student learning in agricultural laboratories. Frequency of use of the laboratories was associated with

between 1.2% (field crops) and 25.7% (meats laboratory) of the variance in perceptions of student learning.

Correlations indicate that teachers using the garden, greenhouse, or landscaping area more frequently tended to perceive greater preparation requirements when using laboratories, while teachers using the livestock/equine facility, meats laboratory, small animal/veterinary laboratory, or nursery/orchard/grove more frequently tended to perceive fewer preparation requirements when utilizing laboratories. Associations between frequency of use of laboratories and variance perceptions of preparation requirements ranged from 1.5% (livestock/equine facility) to 7.0% (garden). While teachers have reported increased preparation requirements when using experiential learning previously (Arnold, Warner, & Osborne, 2006), perceptions of lesser preparation requirements associated with experiential learning in specific laboratories remains unexplained, and therefore lends itself well to future research.

Perceptions of barriers to using agricultural laboratories were positively correlated with frequency of use of the biotechnology/science laboratory, livestock/equine facility, forestry plot, and nursery/orchard/grove, indicating that teachers using these laboratories more often perceived greater barriers to utilizing agricultural laboratories. However, negative correlations indicate that teachers using the aquaculture tank/pond, food science laboratory, or meats laboratory more often perceived fewer barriers to utilizing agricultural laboratories. Associations between perceptions of barriers and frequency of agricultural laboratory use ranged from 1.6% (nursery/orchard/grove) to 3.5% (biotechnology/science laboratory).

Implications and Recommendations

As noted in previous research, the presence and usage of agricultural laboratories to some degree is included in the basic philosophy of secondary agricultural education (Franklin, 2008; McCormick, 1994; Newcomb, McCracken, Warmbrod, & Whittington, 2004; Phipps, Osborne, Dyer, & Ball, 2008). The results of this study regarding laboratory availability and frequency of use support this statement, encouraging researchers and teacher educators to focus on instructional strategies designed for specific contexts available to and used by a large number of agriculture teachers, as is recommended in teacher education (Desimone, 2009).

The number of years teachers were students in secondary agricultural education was associated with a range of variation in frequency of use of specific facilities, providing support for the use of experiential learning in teacher education programs. By exposing preservice teachers to specific agricultural laboratories, they may feel more comfortable utilizing the laboratory as a teacher (Beard & Wilson, 2006). Results also indicate that gender is associated with a wide range of percentages of variance in the frequency of use of specific facilities, further supporting the need for exposure to agricultural laboratories before entering the profession. This need for experiential learning in the context of agricultural laboratories is of great importance currently, as the number of females entering the profession of agricultural education is on the rise (Rocca & Washburn, 2008). Lastly, teachers in more rural schools reported using nine of the agricultural laboratories less frequently than those at suburban or urban schools. With the majority of the nation's agriculture students learning in rural schools, agricultural educators must provide instruction and support to help these teachers utilize agricultural laboratories effectively.

Experiential learning in agricultural laboratories has been established as an ideal setting to teach scientific content and problem solving skills to agriculture students in an effort to better prepare them for careers in the science-based agricultural industry (Enderlin & Osborne, 1992; Myers & Washburn, 2006; NRC, 2009; Thompson, 1998; Washburn & Myers, 2008). However, associations between frequency of laboratory use and teacher perceptions regarding the impact of using specific agricultural laboratories on student learning, the preparation required to effectively use specific agricultural laboratories during instruction, and barriers to using agricultural laboratories vary by laboratory. In order for students to gain valuable experiences that enhance their scientific content and problem solving skills, researchers must work to investigate the causes of these differences in teacher perceptions and their relationship to frequency of use of specific facilities. While self-reporting studies such as this are a useful starting point, more information regarding the actual use of laboratories could be obtained by observational or qualitative research methods. Further, teacher educators should work with teachers to reduce barriers to utilizing laboratories, develop strategies to make preparation in specific laboratories less daunting, and maximize the impact of agricultural laboratories on student learning.

References

- Arnold, S., Warner, W. J., & Osborne, E. W. (2006). Experiential learning in secondary agricultural education classrooms. *Journal of Southern Agricultural Education Research*, 56(1). p. 30-39.
- Beard, C., & Wilson, J. P. (2006). *Experiential learning: a best practice handbook for educators and trainers*. Philadelphia, PA: Kogan Page Limited.
- Broyles, T. W. (2004). *Curriculum and Facilities for Agricultural Education: An Agriscience Approach*. (Doctoral dissertation, Virginia Polytechnic Institute and State University). Retrieved from <http://scholar.lib.vt.edu/theses/available/etd-07022004-162749/unrestricted/01facilitiesforaged.pdf>.
- Camp, W. G., Broyles, T., and Skelton, N. S. (2002). *A national study of the supply and demand for teachers of agricultural education in 1999-2001*. Blacksburg, VA: Virginia Tech., Agricultural Education Program.
- Davis, J. A. (1971). *Elementary survey analysis*. Englewood Cliffs, NJ: Prentice-Hall.
- Desimone, L. M. (2009). Improving impact studies of teachers' professional development: Toward better conceptualizations and measures. *Educational Researcher*, 38(3), p. 181-199.
- Dillman, D. A., Smyth, J. D., & Christian, L. M. (2009). *Internet, mail, and mixed-mode surveys: the tailored design method*. Hoboken, NJ: John Wiley & Sons.

- Enderlin, K. E., & Osborne, E. W. (1992). *Student achievement, attitudes, and thinking skill attainment in an integrated science/agriculture course*. Paper presented at the 19th Annual National Agricultural Education Research Meeting, St. Louis, MO.
- Franklin, E. A. (2008). *Description of the use of the greenhouse facilities by secondary agricultural education instructors in Arizona*. Proceedings of the 2008 Western Region American Association of Agricultural Educators Research Conference, Park City, UT.
- Israel, G. D. (2009). *Determining sample size*. Available at: <http://edis.ifas.edu>.
- Johnson, D. M. (1989). Agricultural mechanics laboratory management competencies: Perceptions of Missouri agriculture teachers concerning importance and performance ability. Unpublished doctoral dissertation, University of Missouri, Columbia.
- Johnson, D. M., Wardlow, G. W., & Franklin, T. D. (1997). Hands-on activities versus worksheets in reinforcing physical science principles: effects on student achievement and attitude. *Journal of Agricultural Education*, 38(3), 9-17.
- Knobloch, N. A. (2003). Is experiential learning authentic? *Journal of Agricultural Education*, 44(4), 22-34.
- Kolb, D. A. (1984). *Experiential Learning*. Englewood Cliffs, NJ: Prentice Hall.
- Layfield, K. D., Minor, V. C., & Waldvogel, J. A. (2001). *Integrating science into agricultural education: A survey of South Carolina teachers' perceptions*. Paper presented at the 28th Annual National Agricultural Education Research Conference, New Orleans, LA.
- Lindner, J. R., Murphy, T. H., Briers, G. E. (2001). Handling nonresponse in social science research. *Journal of Agricultural Education*, 42(4), 43-53.
- Luiselli, J. K., Putnam, R. F., Handler, M. W., & Feinberg, A.B. (2005). Whole-school positive behavior support: effects on student discipline problems and academic performance. *Educational Psychology*, 25(2-3), 183-198.
- McCormick, F. G. (1994). *The Power of Positive Teaching*. Kreiger Publishing Company.
- Miller, L. E., & Smith, K. L. (1983). Handling nonresponse issues. *Journal of Extension*, September/October, 45-50.
- Myers, B. E., Dyer, J. E., & Washburn, S. G. (2005). Problems facing beginning agriculture teachers. *Journal of Agricultural Education*, 46(3), 47-55.
- Myers, B. E., & Washburn, S. G. (2008). Integrating science in the agriculture curriculum: Agriculture teacher perceptions of the opportunities, barriers, and impact on student enrollment. *Journal of Agricultural Education*, 49(2), 27-37

- National Research Agenda, Agricultural Education and Communication (2007). *Research Priority Areas and Initiatives, 2007-2010*.
- National Research Council. (2009). *Transforming Agricultural Education for a Changing World*. Washington, D. C.: The National Academies Press.
- Newcomb, L. G., McCracken, J. D., Warmbrod, J. R. , & Whittington, M. S. (2004). *Methods of Teaching Agriculture* (3rd ed.). Upper Saddle River, NJ: Pearson-Prentice Hall.
- Parr, B., & Edwards, M. C. (2004). Inquiry-based instruction in secondary agricultural education: Problem-solving – an old friend revisited. *Journal of Agricultural Education*, 45(4), 106-117.
- Phipps, L. J., Osborne, E. W., Dyer, J. E., & Ball, A. (2008). *Handbook on agricultural education in public schools*. Clifton Park, NY: Thompson Delmar Learning.
- Randell, R. S., Arrington, , L. R., & Cheek, J. G. (1993). The Relationship of supervised agricultural experience program participation and student achievement in practical skills in agricultural science. *Journal of Agricultural Education*, 34(1), 26-32.
- Rocca, S. J., & Washburn, S. G. (2008). Preservice agriculture teachers perceptions of career barriers and support. *Journal of Agricultural Education*, 49(2), 38-49.
- Thompson, G. W. (1998). Implications of integrating science in secondary agricultural education programs. *Journal of Agricultural Education*, 39(4), 76-85.
- Thompson, G. W., & Balschweid, M. M. (1999). Attitudes of Oregon agricultural science and technology teachers toward integrating science. *Journal of Agricultural Education*, 40(3), 21-29.
- Thompson, G. W., & Schumacher, L. G. (1998). Selected characteristics of the national FFA organization's agriscience teacher of the year award winners and their agriscience programs. *Journal of Agricultural Education*, 39(2), 50-60.
- U.S. Department of Agriculture Cooperative Research, Education, and Extension Service & Perdue University. (2005). *Employment Opportunities for College Graduates in the U.S. Food, Agricultural, and Natural Resources System (2004-38837-01875)*. West Lafayette, IN: Perdue University.
- Washburn, S. G., & Myers, B. E. (2008). *Agriculture teacher perceptions of preparation to integrate science and their current use of inquiry based learning*. Paper presented at the 2008 American Association of Agricultural Educators Conference, Reno, NV.
- Young, R. B., & Edwards, M. C. (2005). A Profile of cooperating teachers and centers in Oklahoma: implications for the student teaching experience in agricultural education. *Journal of Southern Agricultural Education Research*, 55(1), 60-73.

Zurbrick, P. R. (1990). Experiential education. *The Agricultural Education Magazine*, 62(12), 3.

Agricultural Mechanics Laboratory Safety: Professional Development Needs of Kentucky School-Based Agricultural Educators

Dr. P. Ryan Saucier, Texas State University

Dr. Stacy K. Vincent, University of Kentucky

Dr. Ryan G. Anderson, Iowa State University

Abstract

The frequency and severity of accidents that occur in the agricultural mechanics laboratory can be reduced when these facilities are managed by school-based agricultural educators who are competent and knowledgeable in the area of laboratory safety and facility management (McKim, Saucier, & Reynolds, 2010). To ensure that teachers are technically competent and prepared to manage an agricultural mechanics laboratory, teacher educators and state agricultural education supervisory staff must provide comprehensive pre-service education in the area of agricultural mechanics and professional development opportunities that improve teacher retention, program continuity, and ensure a future supply of fully qualified and highly motivated agricultural educators (Osborne, n.d.; Saucier, Terry, & Schumacher, 2009). In this quantitative research study, data were collected with a web-based questionnaire designed to determine Kentucky agriculture teachers' perceptions of the importance of 14 selected agricultural mechanics laboratory safety competencies and their self-assessed ability to perform those competencies. The Borich (1980) Needs Assessment Model was used to assess and evaluate the professional development needs of these teachers. This study found that these educators were in need of agricultural mechanics laboratory safety education in the following competencies: correcting hazardous laboratory conditions, properly installing/maintaining safety devices/emergency equipment, and maintaining the agricultural mechanics laboratory in compliance with Occupational Safety and Health Administration (OSHA) standards, etc. To improve their technical competence, these educators should receive professional development education in the area of laboratory safety and management through technical workshops, winter and summer conferences, and via webinars (Barrick, Ladewig, & Hedges, 1983; Birkenholz & Harbstreit, 1987; McKim, et al., 2010; Saucier, et al., 2009).

Introduction and Literature Review

The need for professional development that improves classroom and laboratory teaching methodologies has continued to exist for school-based agricultural educators (Burris, McLaughlin, Brashears, & Frazee, 2008; Duncan, Ricketts, Peake, & Uessler, 2006; Joerger, 2002; Roberts & Dyer, 2004). This trend is especially true for agricultural educators who utilize an agricultural mechanics laboratory for student instruction and skill acquisition (Saucier & McKim, 2010; McKim, et al., 2010; Saucier, et al., 2009). Numerous studies have found that agricultural educators have professional development needs in the five construct areas of agricultural mechanics laboratory management (Dyer & Andreasen, 1999; Hubert, Ullrich, Lindner, & Murphy, 2003; Johnson, Schumacher, & Stewart, 1990; McKim, et al., 2010; Saucier & McKim, 2010; Saucier et al., 2009; Schlautman & Silletto; Swan, 1992). To ensure that agricultural mechanics laboratories remain a safe place for student educational enrichment, it is

critical that professional development opportunities be offered for teachers who instruct students in these specialized educational facilities (McKim, et al., 2010).

It is difficult to argue the need for professional development in agricultural education, yet the results from teacher pre-service training seem to differentiate. Ruhland and Bremer (2002) believed that an increase of support for professional development can assist with the retention of teachers in their first year of teaching. Burris, et al. (2008) found that personal, general, and content efficacy continued to improve from year one to year five of teaching with the implementation of professional development education. Furthermore, it was found that professional development that focused on specific instructional practices increased teachers' use of those practices in the classroom. Also, specific features, such as active learning opportunities, increased the effect of professional development on teacher's instructional habits towards students (Desimone, Porter, Garet, Yoon, & Birman, 2002).

Teachers need a range of professional development opportunities that will meet their varied and specific needs (Ruhland & Bremer, 2002). These needs consist of an understanding in curriculum development, learning styles, technical areas, teaching methods, teaching techniques, and academic integration methods (Dobbins & Camp, 2000). School-based agricultural educators need appropriate and timely professional development that ensures they are properly equipped to contend with changing conditions in the classroom or laboratory environment (Joerger, 2002). According to a review of literature, modifying the curriculum to meet the changes in technology, effective laboratory teaching methods, and the development of engineering curriculum, were determined as specific agricultural education professional development needs in the area of agricultural mechanics and laboratory management (Custer, & Daugherty, 2009; Peake, Duncan, & Ricketts, 2007; Washburn, King, Garton, & Harbstreet, 2001). After an analysis of secondary students' dissatisfactions with instruction, it was recommended that the profession analyze the area of agricultural mechanics education and seek ways to strengthen it and share the information with the various stakeholders (Reis & Kahler, 1997).

In order for safe laboratory instruction to take place, school-based agricultural educators must be competent and knowledgeable in the area of laboratory management (Saucier, et al., 2009). Phipps, Osborne, Dyer and Ball (2008) wrote that the agriculture teacher is responsible for identifying safety hazards, providing daily safety instruction, and maintaining safe working conditions for students in an agricultural mechanics laboratory. Moreover, the agricultural mechanics laboratory can quickly become an underutilized and unsafe learning environment if ill-prepared teachers are thrust into instruction without adequate pre-service preparation (Hubert, et al., 2003; Newcomb, McCracken, Warmbrod, 1993). Furthermore, "learning cannot take place unless agriculture teachers can provide a safe learning environment for students to develop agricultural mechanics related skills" (McKim, et al., 2010, p. 12).

In the state of Kentucky, an educational reform in 1990 developed a new system of accountability for students, teachers, and school districts – mandating 24 hours of professional development for all classroom teachers (Elmore, Abelman, & Fuhrmann, 1996; Kentucky Department of Education, 2010a). Within the state, agricultural mechanics teachers have not been provided professional development that was assessed, analyzed, or aligned to educational standards — which is considered the first step in developing effective professional development

for teachers (Louks-Horsley, Love, Stiles, Mundry, Hewson, 2003). Furthermore, if the ultimate goal of professional development is to improve the learning outcomes of students (Guskey, 2002), then providing teachers with timely and needed professional development opportunities should be the goal of state supervisory staff and teacher educators (Saucier, et al., 2009). With twenty years of development and revision to state academic standards and the increasing change in technology in agriculture mechanics, little professional development education has been offered to Kentucky teachers.

Theoretical Framework

To guide this non-experimental, quantitative study, two theories were used as the theoretical base: Knowles' theory of andragogy (Knowles, Holton III, & Swanson, 2005) and Bandura's theory of self-efficacy (Bandura, 1997). Knowles' theory proposes that the adult learner must know why they must know a concept, which will likely motivate them to engage in the learning process. Furthermore, it also posits that adults learn experientially; learn as problem solvers, and learn best when the topic is of immediate value to them. Moreover, Knowles' stated that adults should be engaged in the development of their own learning experiences. In addition, it is probable that adult learners may be highly confident and self-directed in one domain of learning, but dependent and hesitant about another (Knowles, et al., 2005; Pratt, 1988). According to this theory, by including adults in the development, implementation, and evaluation of professional development education (e.g. needs assessment research), providers of professional development can offer timely and meaningful opportunities to stakeholders.

Bandura (1997) defined self-efficacy as the "beliefs in one's capabilities to organize and execute the course of action required to produce given attainments" (p. 3). Moreover, self-efficacy influences a person's choices, actions, the amount of effort they give, how long they persevere when faced with obstacles, their resilience, their thought patterns and emotional reactions, and the level of achievement they ultimately attain (Bandura, 1986). In the field of education, teacher self-efficacy is an important concept of understanding teacher motivation (Knobloch & Whittington, 2002). By understanding the way a teacher feels about completing an activity, or their self-efficacy level, professional development opportunities can be developed to address these inadequacies.

As a result, it is important to understand teachers' professional development education needs in the area of agricultural mechanics laboratory management in order for future professional development opportunities to be planned, delivered, and evaluated by teacher educators and state agricultural education leaders. Due to the lack of research regarding the agricultural mechanics laboratory management needs of Kentucky agricultural educators and the continual need for research regarding professional development of these specialized teachers (Osborne, n.d.), a current assessment of these needs is warranted and should be conducted.

Purpose and Research Objectives

The purpose of this study was to describe the laboratory safety professional development needs of agriculture teachers in Kentucky who teach within an agricultural mechanics laboratory. The following research objectives were investigated to accomplish this purpose:

1. Identify the personal and professional demographic characteristics of Kentucky school-based agriculture educators who teach agricultural mechanics courses.
2. Identify the demographic characteristics of agricultural education programs in Kentucky that offer agricultural mechanics courses.
3. Determine the self-perceived level of importance that Kentucky school-based agricultural educators, who teach agricultural mechanics courses, place upon selected agricultural mechanics laboratory safety competencies.
4. Determine the self-perceived ability level of Kentucky school-based agricultural educators, who teach agricultural mechanics courses, regarding selected agricultural mechanics laboratory safety competencies.
5. Determine the professional development needs of Kentucky school-based agricultural educators, who teach agricultural mechanics courses, regarding selected agricultural mechanics laboratory safety competencies.

Procedures

Population

The population for this non-experimental, quantitative study was school-based agriculture teachers in Kentucky during the spring of 2010. The *2009-2010 Kentucky Agricultural Education Directory*, included a total of 248 school-based agriculture teachers. Due to the number of subjects and the ease of electronic data collection, a census was conducted to more accurately describe the characteristics of the population and eliminate potential errors associated with subject selection and sampling error.

Instrumentation

The data collection instrument developed by Johnson, Schumacher, and Stewart (1990), and later modified by Saucier, et al. (2009), was used for data collection in this study. To address the research questions of this study, a two-section instrument was utilized. The first section of the instrument consisted of a double-matrix (70 statements) that consisted of agricultural mechanics laboratory management competencies. A 5-point, Likert-type scale, with double-matrices allowed subjects to respond to each statement twice; once rating the perceived importance of each skill competency (1 = *No Importance*, 2 = *Below Average Importance*, 3 = *Average Importance*, 4 = *Above Average Importance*, 5 = *Utmost Importance*), and also rating the individual's ability to perform the skill competency (1 = *No Ability*, 2 = *Below Average Ability*, 3 = *Average Ability*, 4 = *Above Average Ability*, 5 = *Exceptional Ability*). The second section sought to identify personal, professional, and program demographic characteristics of the respondents and the agricultural education programs' in which they taught at (e.g., age, sex, ethnicity, years of teaching experience, highest degree obtained, largest student enrollment in an agricultural mechanics course, etc.)

In 1989, Johnson and Schumacher developed an instrument that included 50 competencies developed through a modified Delphi technique, with input from a national panel of agricultural mechanics education experts, and was reported to be valid. Johnson et al. (1990) later modified Johnson and Schumacher's instrument to include a double-matrix format to assess the perceived importance of each competency and the perceived ability of the individual to perform each competency. A later study conducted by Saucier, et al., (2009) modified Johnson et al. (1990) instrument by separating multiple-component or *double-barreled* and *triple-barreled* competencies into single-component competencies, therefore, 50 competencies were expanded to 70 competencies.

The design and format of the data collection instrument was guided by the suggestions of Dillman (2007). To ensure face validity, the researchers used a web-based questionnaire design and delivery service, Hosted Survey™, to create and distribute the instrument to a panel of experts. The panel of experts ($N = 7$) consisted of two faculty members from one regional university in Kentucky, three doctoral graduate students with prior school-based agricultural education teaching experience, an agricultural education faculty member, and an agricultural education faculty member with expertise in instrument development and research methodology.

Saucier, et al. (2009) assessed content validity of their instrument using a panel of experts ($N = 7$) that consisted of agricultural education and agricultural systems management faculty members who judged the instrument to be valid. The panel further identified five constructs: laboratory and equipment maintenance; laboratory teaching; program management; tool, equipment, and supply management; and laboratory safety. This study used the exact competencies previously determined to be valid in the study conducted by Saucier et al.; therefore, the constructs were considered to be valid.

To estimate reliability of the instrument for this study, Cronbach's alpha coefficients were calculated using data collected in a study of secondary agriculture teachers in Missouri during 2008 ($n = 110$). Because data were collected in a similar manner, from a sample with similar characteristics, using the same data collection instrument used in this study, the data were deemed appropriate to estimate reliability of the data collection instrument for use in Kentucky (Saucier, et al., 2009). Therefore, Cronbach's alpha coefficients were calculated for the scales (importance and ability), yielding coefficients of .97 and .97 ($n = 110$) respectively. The Cronbach's alpha coefficients for the five constructs (Saucier, et al., 2009)—laboratory and equipment maintenance; laboratory teaching; program management; tool, equipment, and supply management; and laboratory safety—ranged from .87 to .90 ($n = 110$). To ensure the reliability of the instrument for this study, the researchers conducted a *post hoc* reliability estimate using Cronbach's alpha coefficients for both scales (importance and ability) for each of the five constructs of the instrument. Reliability estimates ranged from .88 to .93 ($n = 87$).

Methods

Dillman's (2007) data collection protocol was followed for this study. After five points of contact, a response rate of 35.01% ($n = 87$) was obtained. Non-response error was a relevant concern; therefore, procedures for handling non-respondents were followed as outlined as *Method 1* in Lindner, Murphy, and Biers (2001). An independent samples *t* test indicated that no

significant differences ($p < .05$) existed between the early and late respondents based on their perceptions of the importance of, or their ability to perform, each of the agricultural mechanics laboratory management competencies. Therefore, external validity did not threaten the generalizability of the findings of this study to the target population (Lindner, et al.).

Data Analysis

Data were analyzed using SPSS® version 18.0 for Windows™ based computers. In determining the appropriate analysis of the data, the primary guidance was scales of measurement as outlined by Ary, Jacobs, Razavieh, and Sorensen (2006). Research objective one sought to describe the demographic characteristics of school-based agriculture teachers in Kentucky; thus, frequencies and percentages for gender, level of academic degree attained, and type of teacher certification program were calculated. In addition, mean and standard deviations were determined for demographics such as: age, years of teaching experience, university semester credit hours earned in agricultural mechanics coursework, hours spent weekly supervising student work in the agricultural mechanics laboratory. For research objective two (demographic characteristics of agricultural education programs in Kentucky that offer agricultural mechanics courses), mean and standard deviations were calculated for the following characteristics: annual student enrollment for agricultural mechanics courses, student enrollment per agricultural mechanics course, age of agricultural mechanics laboratory, and size of agricultural mechanics laboratory, etc.

Research objective three sought to describe the perceived importance of selected agricultural mechanics laboratory safety competencies by school-based agriculture teachers. Additionally, research objective four sought to describe secondary agricultural education teachers' perceived ability to perform selected agricultural mechanics laboratory safety competencies. Both mean and standard deviations were calculated for these objectives.

Research objective five sought to prioritize the agricultural mechanics laboratory safety competencies in need of improvement, as perceived by school-based agriculture teachers in Kentucky. To determine the professional development needs of the respondents, the Borich (1980) needs assessment model was utilized to determine the discrepancy (importance level and ability level) for each competency. In accordance with this model, a Mean Weighted Discrepancy Score (MWDS) was calculated for each competency using the following formula:

$$\text{MWDS} = \frac{[(\text{Importance Rating} - \text{Ability Rating}) \times (M \text{ Importance Rating})]}{\text{Number of Observations}}$$

A large mean MWDS represents greater in-service needs, while smaller scores represent lesser in-service needs (Borich, 1980).

Findings

Research Objective # 1

The average respondent was 37 ($M = 37.47$; $SD = 10.90$) years of age and has taught school-based agricultural education for over 11 years ($M = 11.56$; $SD = 9.15$). While completing

their bachelor's degree, the respondents indicated that they completed an average of 10 university semester credit hours of agricultural mechanics coursework ($M = 10.08$; $SD = 8.73$). Additionally, teachers reported that they supervise student work in the agricultural mechanics laboratory for an average rate of more than 9 hours ($M = 9.17$; $SD = 7.64$) per week (see Table 1).

Table 1
Selected Personal Demographics of School-based Agriculture Teachers in Kentucky (n = 87)

Characteristic	<i>M</i>	<i>SD</i>	Min	Max
Age	37.47	10.90	23	58
Years of teaching experience	11.56	9.15	0	33
University semester credit hours earned in agricultural mechanics coursework	10.08	8.73	0	60
Hours spent weekly supervising student work in the agricultural mechanics laboratory	9.17	7.64	0	35

To further describe the population, a summary of selected personal, professional, and program demographic characteristics of Kentucky school-based agriculture teachers were identified. The respondents consisted of 70 (80.50%) male teachers and 17 (19.50%) female agriculture teachers. The majority ($f = 52$; 59.80%) of these teachers indicated that they possessed a master's degree and were certified to teach agricultural education ($f = 87$; 100.00%).

Research Objective # 2

The average annual student enrollment for agricultural mechanics courses was 91 students per year ($M = 91.04$; $SD = 69.05$). Respondents indicated that the average student enrollment in the largest agricultural mechanics class was over 25 students ($M = 25.97$; $SD = 5.95$). Teachers also reported that the average age of the agricultural mechanics laboratory was slightly over 27 years of age ($M = 27.48$; $SD = 13.75$) and was 2,645 square feet in size ($M = 2,645.82$; $SD = 5,826.98$). Based upon the results from the respondents, the total number of students enrolled in all agricultural mechanics courses and the size of the agricultural mechanics laboratory (ft^2), each student was provided with 85.14 ft^2 ($SD = 77.33 \text{ ft}^2$) of laboratory workspace. According to the respondents, the average consumable budget for agricultural mechanics programs was \$1,849.32 ($SD = \$2,223.01$). Furthermore, the consumable budget spent per student in a Kentucky agricultural mechanics program was \$24.19 ($SD = \26.92). Please see Table 2 for a summary of the results indicated above.

The largest amount of Kentucky school-based agricultural educators indicated that they instruct students at schools located in rural communities ($f = 48$; 55.20%) where total student enrollment in the agricultural education program is between 150 to 249 students ($f = 34$; 39.10%). Additionally, these teachers work in a two teacher agricultural education program ($f = 49$; 56.30%) and teach in a school that utilizes a seven period per day class schedule ($f = 30$; 34.50%).

Table 2

Selected Program Demographics of School-based Agriculture Teachers in Kentucky (n = 87)

Characteristic	<i>M</i>	<i>SD</i>	Min	Max
Average student enrollment in agricultural mechanics courses	25.97	5.95	7	35
Total student enrollment in agricultural mechanics courses	91.04	69.05	13	360
Size of agricultural mechanics laboratory (ft ²)	2,029.38	1,581.34	200	12,000
Size of agricultural mechanics laboratory work space per student (ft ²)	85.14	77.33	10	545
Age of the agricultural mechanics laboratory	27.48	13.75	1	55
Consumable budget (\$)	1,849.32	2,223.01	0	10,000
Consumable budget (\$) per student	24.19	26.92	0	133

Research Objective(s) # 3, 4, & 5

The construct category *Laboratory Safety* was operationally defined by Saucier, et al. (2009, p. 13) as “all activities that an agriculture teacher must perform to maintain a safe laboratory learning environment for students.” Research objective three sought to describe Kentucky school-based agricultural teachers’ perceived levels of importance of selected competencies of agricultural mechanics laboratory safety. *Providing students safety instruction* ($M = 3.83$; $SD = 0.46$), *administering first aid* ($M = 3.51$; $SD = 0.66$), and *correcting hazardous laboratory conditions* ($M = 3.49$; $SD = 0.70$) were perceived to be the three competencies with the highest levels of importance by the respondents. The three competencies that were perceived to have the least importance were: *promoting laboratory safety by color coding equipment/markings safety zones/posting appropriate safety signs and warnings* ($M = 2.70$; $SD = 0.82$), *arranging equipment in the agricultural mechanics lab to enhance safety/efficiency/learning* ($M = 3.13$; $SD = 0.76$), and *maintaining healthy environmental conditions in the laboratory* ($M = 3.14$; $SD = 0.82$). The mean level of importance that respondents placed upon the 14 laboratory safety competencies were 3.33 ($SD = 0.73$), or average importance, and the mean level of importance for each competency ranged from 2.70 to 3.83. (see Table 3)

Research objective four sought to describe teachers’ perceived ability to perform selected agricultural mechanics laboratory safety competencies. Mean values of school-based agriculture teachers’ perceived ability to perform selected competencies ranged from 2.26 to 3.28. Teachers’

perceived themselves as possessing an average ability to perform 86% ($n = 12$) of the 14 laboratory safety competencies. Respondents' perceived themselves as possessing a below average ability to complete the two constructs: *promoting laboratory safety by color coding equipment/marketing safety zones/posting appropriate safety signs and warnings* ($M = 2.26$; $SD = 0.77$) and maintaining the agricultural mechanics laboratory in compliance with Occupational Safety and Health Administration (OSHA) standards ($M = 2.32$; $SD = 0.88$). However, teachers' perceived themselves as possessing an average ability to perform the remaining 12 competencies. The three competencies in which the respondents perceived their ability to be the highest were: *providing students safety instruction* ($M = 3.28$; $SD = 0.74$), *selecting protective equipment for student use* ($M = 3.05$; $SD = 0.75$), and *developing an accident reporting system* ($M = 2.85$; $SD = 0.87$). Please see Table 3 for a summary of the results.

In the laboratory safety construct, the average MWDS was 1.67. In this construct, the laboratory management competency *correcting hazardous laboratory conditions* ranked as the highest in-service need with a MWDS of 2.10. The laboratory management competency with the least need for in-service education in this construct was *promoting laboratory safety by color coding equipment/marketing safety zones/posting appropriate safety signs and warnings* with a MWDS of 0.99. These data are presented in Table 3.

Table 3
Mean Weighted Discrepancy Scores for Competencies Related to Laboratory Safety (n = 87)

Rank	Competency Construct	MWDS	Importance		Ability	
			\bar{X}	<i>SD</i>	\bar{X}	<i>SD</i>
1	Correcting hazardous laboratory conditions.	2.10	3.49	0.70	2.72	0.85
2	Properly installing/maintaining safety devices/emergency equipment (e.g., fire extinguishers, first aid supplies, machine guards, etc.)	2.03	3.38	0.74	2.60	0.84
3	Maintaining the agricultural mechanics laboratory in compliance with Occupational Safety and Health Administration (OSHA) standards.	2.00	3.18	0.84	2.32	0.88
4	Administering first aid.	1.94	3.51	0.66	2.82	0.86
5	Providing students safety instruction.	1.81	3.83	0.46	3.28	0.74
6	Conducting regular safety inspections of the laboratory.	1.80	3.26	0.72	2.56	0.92
7	Safely handling hazardous materials (e.g., flammables, acids, and compressed gas cylinders.)	1.69	3.43	0.76	2.83	0.81
8	Developing an accident reporting system.	1.67	3.44	0.74	2.85	0.87
8	Maintaining protective equipment for student use (e.g., safety eyewear.)	1.67	3.34	0.74	2.74	0.78
10	Maintaining healthy environmental conditions in the laboratory (e.g., temperature, light, ventilation.)	1.54	3.14	0.82	2.53	0.79
11	Arranging equipment in the agricultural mechanics lab to enhance safety/efficiency/learning.	1.40	3.13	0.76	2.59	0.86
12	Documenting student safety instruction.	1.37	3.31	0.75	2.83	0.77
13	Selecting protective equipment for student use (e.g., safety eyewear.)	1.33	3.48	0.66	3.05	0.75
14	Promoting laboratory safety by color coding equipment/markings safety zones/posting appropriate safety signs and warnings.	0.99	2.70	0.82	2.26	0.77
	Mean rating for scales (Importance & Ability)		3.33	0.73	2.71	0.82
	Average MWDS for the laboratory safety construct	1.67				

Note: Importance Scale: 1 = No Importance, 2 = Below Average Importance, 3 = Average Importance, 4 = Above Average Importance, 5 = Utmost Importance; Ability Scale: 1 = No Ability, 2 = Below Average Ability, 3 = Average Ability, 4 = Above Average Ability, 5 = Exceptional Ability.

Conclusions, Implications, & Recommendations

Numerous studies have found that agricultural educators have professional development needs in the area of agricultural mechanics laboratory management (McKim, et al., 2010; Saucier & McKim, 2010; Saucier, et al., 2009). Additionally, Saucier, et al. (2009) suggested that research be conducted to determine the educational needs of teachers concerning laboratory management and the safety of agricultural laboratories. The agricultural education teachers in this study reported having less pre-service instruction in agricultural mechanics coursework than their current counter-parts in Missouri (Saucier, et al., 2009). This lack of education can lead to several questions. Do teachers know or understand their actual knowledge level of laboratory safety? Who evaluates the agricultural mechanics laboratory at the school in which they teach? Is the laboratory at the school in which they teach safe for student instruction? Can a lack of pre-service education in the area of agricultural mechanics contribute to an unsafe laboratory environment? These questions and others are grounds for future research.

The researchers have identified the agricultural mechanics laboratory management competencies of *correcting hazardous laboratory conditions, properly installing/maintaining safety devices/emergency equipment (e.g., fire extinguishers, first aid supplies, machine guards, etc.)*, and *maintaining the agricultural mechanics laboratory in compliance with OSHA standards* as the highest professional development needs of the participants in this study. According to Bandura (1997), adults learn best when the topic is of immediate value to them. If this is the case, should teachers be involved in designing, implementing, and evaluating professional development workshops concerning agricultural mechanics laboratory safety? The researchers recommend that the Kentucky Department of Education provide professional development workshops on agricultural mechanics laboratory safety that are led or assisted by an Occupational Safety and Health Administration (OSHA) compliance officer. This will ensure that participants can identify and correct safety hazards in their respective laboratories.

Due to this popularity of the courses and the potential dangers and hazards that exist in an agricultural mechanics laboratory, it is critical that pre-service and in-service education programs be provided for teachers who manage these facilities. Such programs should be offered with frequency and variety and should be delivered in formats and at times that will have the greatest impact upon the largest number of teachers. Additionally, these programs should focus on the needs of teachers based upon career stage and avoid a *cookie cutter* approach for all. This goal could be accomplished by providing teachers with workshops offered during the winter and summer breaks, agricultural education laboratory management courses offered for continuing education or university graduate courses for credit. Online, self-directed courses or webinars might also be an option for teachers with travel limitations. Winter and summer workshops focusing on agricultural mechanics should be offered at regional locations throughout the state of Kentucky and could be located at university or public school facilities.

According to the guidelines for Kentucky agricultural education programs, which are outlined in the *Facilities Guide for Career and Technical Education* (Kentucky Department of Education, 2010b), an agricultural mechanics laboratory should be 2,000 square feet and/or 120 square feet per student — which would equate to just fewer than 17 students in the typical Kentucky agricultural mechanics laboratory. Phipps et al. (2008) suggest that students should have 150 square feet of workspace in an agricultural mechanics laboratory, based upon the reported agricultural mechanics laboratory size of just over 2000 square feet, this would equate

to just over 13 students in the typical agricultural mechanics laboratory in Kentucky. While the findings in this study suggest that the laboratory size reported by the participants meets the standards set forth in the *Facilities Guide for Career and Technical Education* (Kentucky Department of Education), the amount of square footage per student does not. The respondents reported an average enrollment of 26 students in agricultural mechanics courses. This suggests that there are twice as many students in the space provided as recommended by Kentucky guidelines. Overcrowding is not new to agricultural education, nor is lower student learning outcomes in overcrowded classes – the larger issue in agricultural mechanics laboratories being overcrowded is safety. Does the lack of space per student in the laboratory increase their chance of being involved in an accident? Should class enrollment in agricultural mechanics courses be limited to a safe student/space requirement? Does academic attainment and success increase if enrollment in these courses is set at a safe level? These questions and others are grounds for future research. Based upon the results of this study, the researchers recommend that agricultural education teachers work with their respective administrators to reduce the number of students in an agricultural mechanics laboratory to increase student learning and student safety.

It should also be noted that the consumable budgets for programs in Kentucky are roughly \$20 per student; which is significantly lower than the \$52 budgeted for students in Missouri (Saucier, et al., 2009). The reduction in budget may lead agriculture teachers to cut out selected safety items or elect to utilize cheaper versions of safety equipment. A teacher may elect to use traditional welding helmets and not utilize auto-darkening helmets; this may increase the student's potential exposure to arc flashes. The reduced budgets may also lead to students using equipment that are unsafe or potentially dangerous. Teachers may be currently using traditional table saws because they do not have the budget to replace them with a modern table saw that has the safety features that are found on a Sawstop® table saw. The researchers recommend that agricultural education teachers work with their school administrators to develop a plan to identify damaged and/or potentially unsafe equipment and replace them with modern, safe equipment. Teachers who continue to use unsafe equipment, such as a traditional table saw, are placing students in a potentially dangerous situation that may lead to accidents and possibly position the teacher/administration into being named liable in a lawsuit for professional negligence.

Furthermore, the average Kentucky agricultural education program has 91 students who complete an agricultural mechanics course annually. This number suggests that agricultural mechanization is still a popular and relevant course in Kentucky secondary agricultural education programs. Teacher education programs should recognize the important role of agricultural mechanics and ensure that pre-service teachers are adequately educated to instruct agricultural mechanics courses for the nine hours a week that has been reported and be able to identify and prevent potential safety hazards in the agricultural mechanics laboratory. Additionally, teacher education programs that are graduating unprepared agricultural education teachers to teach agricultural mechanics are also putting themselves in jeopardy of being named negligent in a lawsuit. If these programs are truly developing fully qualified and highly motivated educators (Osborne, n.d.), then why are teachers who do not possess laboratory safety and agricultural mechanics technical skills considered for teacher certification? It is recommended that teacher education programs create a rigorous pre-service program of courses in the area of agricultural mechanics for agricultural education students and develop a teacher induction program that will aid existing teachers in the areas of agricultural mechanics laboratory safety and management. It

is also recommended that teacher educators make at least one on-site visit with first year teachers to assist in identifying unsafe and or potentially hazardous laboratory conditions.

References

- Ary, D., Jacobs, L. C., Razavieh, A., & Sorensen, C. (2006). *Introduction to research in education*. (7th ed.). Belmont, CA: Wadsworth Publishing.
- Bandura, A. (1986). *Social foundations of thought and action: A social cognitive theory*. Englewood Cliffs, N.J.: Prentice Hall.
- Bandura, A. (1997). *Self-efficacy: The exercise of control*, New York: W.H. Freeman.
- Barrick, R. K., Ladewig, H. W., & Hedges, L. E. (1983). Development of a systematic approach to identifying technical inservice needs of teachers. *Journal of American Association of Teacher Educators in Agriculture*, 24(1), 13-19. doi: 10.5032/jaatea.1983.01013
- Birkenholz, R. J., & Harbstreet, S. R. (1987). Analysis of the inservice needs of beginning vocational agricultural teachers. *Journal of the American Association of Teacher Educators in Agriculture*, 28(1), 41-49. doi: 10.5032/jaatea.1987.01041
- Borich, G. D. (1980). A needs assessment model for conducting follow-up studies. *The Journal of Teacher Education*, 31(3), 39-42. doi: 10.1177/002248718003100310
- Burris, S., McLaughlin, E. K., Brashears, T., & Frazee, S. (2008). Personal teaching efficacy, general teaching efficacy, and content efficacy: A comparison of first and fifth year agriculture teachers. *Proceedings of the 2008 Western Region AAEA Research Conference*, 27(1), 142-153.
- Custer, R. L., & Daugherty, J. L. (2009). Professional development for teachers of engineering: Research and related activities. *The Bridge*, 39(3), 18-24.
- Desimone, L. M., Porter, A. C., Garet, M. S., Yoon, K. S., & Birman, B. F. (2002). Effects of professional development on teachers' instruction: Results from a three-year longitudinal study. *Educational Evaluation and Policy Analysis*, 24(2), 81-142. doi: 10.3102/01623737024002081
- Dillman, D. A. (2007). *Mail and internet surveys: The tailored design method* (2nd ed.). John Wiley & Sons: Hoboken, NJ.
- Dobbins, T. R., & Camp, W. G. (2000). Clinical experiences for agricultural teacher education programs in North Carolina, South Carolina, and Virginia. *Proceedings of the 27th Annual National Agricultural Education Research Conference*, 27(1), 543-555.
- Duncan, D. W., Ricketts, J. C., Peake, J. B., & Uessler, J. (2006). Teacher preparation and inservice needs of Georgia agriculture teachers. *Journal of Agricultural Education*, 47(2), 24-35. doi: 10.5032/jae.2006.02024

- Dyer, J. E., & Andreasen, R. J. (1999). Safety issues in agricultural education laboratories: A synthesis of research. *Journal of Agricultural Education*, 40(2), 46-52. doi: **10.5032/jae.1999.02046**
- Elmore, R. F., Abelman, C. H., & Fuhrman, S. H. (1996). The new accountability in state education reform: From process to performance. In H. F. Ladd (Ed.), *Holding schools accountable: Performance-based reform in education* (p. 65-98). Washington, DC: The Brookings Institution.
- Guskey, T. R. (2002). Professional development and teacher change. *Teachers and teaching: Theory and practice*, 8(34), 381-391.
- Hubert, D., Ullrich, D., Lindner, J., & Murphy, T. (2003). An examination of Texas agriculture teacher safety attitudes based on a personal belief scale from common safety and health practices. *Journal of Agricultural Systems, Technology and Management*, 17.
- Joerger, R. M. (2002). A comparison of the in-service education needs of two cohorts of beginning Minnesota agricultural education teachers. *Journal of Agricultural Education*, 43(3), 11-24. doi: **10.5032/jae.2002.03011**
- Johnson, D. M., & Schumacher, L. G. (1989). Agricultural mechanics specialists identification and evaluation of agricultural mechanics laboratory management competencies: A modified delphi approach. *Journal of Agricultural Education*, 23-28. doi: **10.5032/jae.1989.03023**
- Johnson, D. M., Schumacher, L. G., & Stewart, B. R. (1990). An analysis of the agricultural mechanics laboratory management inservice needs of Missouri agriculture teachers. *Journal of Agricultural Education*, 31(2), 35-39. doi: **10.5032/jae.1990.02035**
- Knobloch, N. A. & Whittington, M. S. (2002). Novice teachers' perceptions of support, teacher preparation quality, and student teaching experience related to teacher efficacy. *Journal of Vocational Educational Research*, 27(3).
- Knowles, M. S., Holton III, E. F., & Swanson, R. A. (2005). *The Adult Learner*. San Diego, CA: Elsevier.
- Lindner, J. R., Murphy, T. H., & Briers, G. E. (2001). Handling nonresponse in social science research. *Journal of Agricultural Education*, 42(4), 43-52. doi: 10.5032/jae.2001.04043
- Loucks-Horsley, S., Love, N., Stiles, K. E., Mundry, S., & Hewson, P.W. (2003). *Designing professional development for teachers of science and mathematics education* (2nd ed.). Thousand Oaks, CA: Corwin.
- McKim, B. R., Saucier, P. R., & Reynolds, C. L. (2010). Laboratory management in-service needs of Wyoming secondary agriculture teachers. *Paper presented at the 2010 American Association for Agricultural Education Conference, USA.*

- Newcomb, L. H., McCracken, J. D., & Warmbrod, J. R. (1993). *Methods of teaching agriculture*. (2nd ed.). Danville, IL: Interstate Publishers.
- Osborne, E. W. (Ed.) (n.d.). *National research agenda for agricultural education and communication: 2007-2010*. Gainesville: University of Florida, Department of Agricultural Education and Communication, 20.
- Peake, J. B., Duncan, D. W., & Ricketts, J. C. (2007). Identifying technical content training needs of Georgia agriculture teachers. *Journal of Career and Technical Education*, 23(1), 44-54.
- Pratt, D. D. (1988). Andragogy as a relational construct. *Adult Education Quarterly*, 38(3), 160-181. doi: 10.1177/0001848188038003004
- Phipps, L. J., Osborne, E. W., Dyer, J. E., & Ball, A. B. (2008). *Handbook on agricultural education in public schools* (6th ed.). Clifton Park, NY: Thomson Delmar Learning
- Reis, R., & Kahler, A. A. (1997). Factors influencing enrollment in agricultural education programs as expressed by Iowa secondary agricultural education students. *Journal of Agricultural Education*, 38(2), 38-48. doi: **10.5032/jae.1997.02038**
- Roberts, T. G., & Dyer, J. E. (2004). In-service needs of traditionally and alternatively certified agricultural teachers. *Journal of Agricultural Education*, 45(4), 57-70. doi: **10.5032/jae.2004.04057**
- Ruhland, S. K., & Bremer, C. D. (2002). Professional development needs of novice career and technical education teachers. *Journal of Career and Technical Education*, 19(1). Retrieved from <http://scholar.lib.vt.edu/ejournals/JCTE/v19n1/ruhland.html>.
- Saucier, P. R., & McKim, B. R. (2010). Agricultural mechanics laboratory management professional development needs of Texas agricultural education student teachers. *Paper presented at the 2010 Association for Career and Technical Education Conference, USA*.
- Saucier, P. R., Terry, Jr. R., & Schumacher, L. G. (2009). Laboratory management in-service needs of Missouri agriculture educators. *Paper presented at the 2009 Southern Region of the American Association for Agriculture Education Conference, USA*, 176-192.
- Schlautman, N. J., & Silletto, T. A. (1992). Analysis of laboratory management competencies in Nebraska agricultural education programs. *Journal of Agricultural Education*, 33(4), 2-8. doi:**10.5032/jae.1992.04002**
- Kentucky Department of Education. (2010a, January 15). *Professional Development*. Retrieved From <http://www.education.ky.gov/kyde/administrative+resources/professional+development/>.
- Kentucky Department of Education, Career and Technical Education. (2010b). *Facilities guide for career and technical education*. Retrieved from <http://www.education.ky.gov/KDE/>

educational+resources/career+and+technical+education/career+and+
technical+ed+resources/facilities/guide.htm

- Swan, M. K. (1992). An analysis of agricultural mechanics safety practices in agricultural science laboratories. *Paper presented at the American Vocational Association Convention, St. Louis, MO.*
- Washburn, S. G., King, B. O., Garton, B. L., & Harbstreit, S. R. (2001). *A comparison of the professional development needs of Kansas and Missouri teachers of agriculture.* Paper presented at 28th Annual National Agricultural Education Research Conference, New Orleans, LA.



Poster Selection Process
Southern Region Agricultural Education Conference
February 5-8, 2011
Corpus Christi, Texas

Seventy-nine submissions were received with forty-two in the innovative idea category and thirty-seven in the research category. The acceptance rate for innovative idea posters was 74% and research posters was 73%.

Poster Reviewers

The following people generously and professionally donated their time to review poster abstracts. Without their commitment, the poster session would not be possible.

Anderson, Ryan	Iowa State University
Anderson, Shawn	Oregon State University
Arnold, Shannon	Montana State University
Aschenbrener, Mollie	Chico State University
Brierton, Sara	North Carolina State University
Coley, Michael	North Carolina State University
Falk, Jeremy	The Ohio State University
Johnson, Lendy	North Carolina State University
Killingsworth, Justin	University of Missouri
Kinney, Justine	North Carolina State University
Lambert, Misty	Oregon State University
Lawver, Rebecca	Utah State University
Martin, Michael	University of Missouri
McGuire, Jerry	The Ohio State University
Mouton, Lauren	North Carolina State University
Stair, Kristin	New Mexico State University
Swan, Ben	California Polytechnic State University
Thieman, Erica	University of Missouri
Thoron, Andrew	University of Illinois
Uricchio, Cassie	North Carolina State University

A Longitudinal Study of Challenges and Threats from County Extension Program Reviews

Melissa Mazurkewicz
University of Florida
PO Box 110540
Gainesville, FL 32643
352-392-0502 ext. 244
mmazurkewicz5@ufl.edu

Amy Harder
University of Florida
PO Box 110540
Gainesville, FL 32643
352-392-0502 ext. 230
amharder@ufl.edu

A Longitudinal Study of Challenges and Threats from County Extension Program Reviews

Introduction/Need for Research

County program reviews of [State] Extension are conducted annually ([Authors], 2009). The reviews are used “to assess program quality, facilitate program improvement, foster cooperation among Extension's various units, and assist in achieving the best use of institutional resources” (Jacob, Israel, & Summerhill, 1998, para. 1). Extension has to ensure that program quality is high in order to serve the diverse stakeholders including the community audience, government officials, partners, funders, and other community members (Braverman & Engle, 2009). The county program reviews are one of the tools used by [State] Extension to assess program ([Authors], 2010). The purpose of this study was to determine trend affecting program quality in [State] Extension.

Theoretical/Conceptual Framework

The conceptual model created by [Authors] (2009) was used. This model was compiled based on the theoretical works of Boyle (1981), English and Kaufman (1975), Witkin and Altschuld (1995), and Mclean (2006). According to Boyle's (1981) work based on Lewin's field theory, organizations undergo changes that can cause disequilibrium. Because of the shift in equilibrium a gap can form creating needs in the organization (Boyle, 1981) Needs assessments are necessary in order to make decisions regarding organizational improvement and shorten the gap between how the organization is and how it should be (Witkin & Altschuld, 1995). A needs assessment is a method used to determine what actions should be taken in order to be able to reduce the gap (English & Kaufman, 1975). McLean (2006) identified the possibility of both favorable and unfavorable responses to the needs assessment. Ideally needs assessments lead to a reduction in disequilibrium while improving the organization.

Methodology

The purpose of this study was to develop an understanding of the trends affecting the quality of county extension programs in [State]. Specifically, this study compared the challenges and threats identified during the county program review process to determine where similarities existed over time. A longitudinal analysis was done using qualitative research methods. Data were obtained from the final reports of the county program reviews ($N = 18$) conducted in 2008 ($n = 8$), 2009 ($n = 5$), and 2010 ($n = 5$). These years were selected as the time frame because a new program review process was officially established in 2008, after a pilot run in 2007. The counties reviewed included some of the state's largest urban counties and smallest rural counties; each district had at least one county reviewed in each of the years selected.

The final reports were analyzed using the constant comparative method to determine emergent themes (Lincoln & Guba, 1985). The final reports outline the strengths, challenges, opportunities, and threats that an external review team perceives to affect the quality of program delivery in a county ([Authors], 2009). Of the four sections, challenges and threats were analyzed for this study. Challenges are internal weaknesses whereas threats are external issues that have the potential to negatively affect the quality of extension programming ([Authors], 2009). Trustworthiness was established using triangulation and member checks (Lincoln & Guba, 1985).

Results/Findings

Overall there were eleven challenges found throughout the time frame. There were seven threats identified. Two challenges of *marketing deficits* and *technology barriers* were consistent throughout the three years. An indicator of a *marketing deficit* was “effective and increased marketing of the public value of Extension and increased partnerships should be undertaken as a goal in the short, intermediate and long-term strategic plan.” Technology barriers were identified in statements such as “use of technology requires specialized skills creating a need for

additional faculty training.” The *loss of human capital* was found to be a challenge in both 2008 and 2009. In 2009 and 2010 the common challenges were *programming for underrepresented audiences* and the *lack of an advisory council or representative advisory council*.

The three threats that were found consistently across the three years analyzed were the following: *economy*, *changing demographics*, and *insufficient facilities*. The following statement highlights an indicator of the threat of *economy*: “The overall economy of the state, region and the nation has a negative impact on the present and future delivery of Extension programs.” *Changing demographics* was elicited from the program reviews in statements such as “Programmatic changes may include a shift from agrarian toward more suburban residence.” *Lack of technology access* was a threat found in 2009 and 2010.

Conclusions

Improvement is necessary in the area of marketing. Due to the shifting role of Cooperative Extension and varying perspectives on Extension it is important for Cooperative Extension to have a marketing plan (Varea-Hammond, 2004). Varea-Hammond (2004) stated a marketing plan is needed in order to justify funding and support, internal benefits, and to compete with comparable organizations and sources of information.

County faculty are not universally proficient in the use of different technologies that can be used to enhance programming. Professional development with a focus on technology training has been cited as a concern in Cooperative Extension (Ferrell, 2005). Even when faculty are proficient, technology access remains a program particularly in rural areas.

The loss of human capital and the potential for agent burnout is a common challenge in Cooperative Extension. These challenges are similar and related to staff and faculty morale. Safrit and Owen (2010) noted the loss of human capital continues to plague and create negative impact for Cooperative Extension despite efforts to prevent agent turnover.

Changing demographics are increasingly a threat. [Authors] (2009) suggested that innovative programs be offered to meet the needs of the diverse group of stakeholders. The current state of the economy is reflected in the quality of the facilities. A stable source of funding is needed in order to help remedy the presence of insufficient facilities.

Implications/Recommendations/Impact on Profession

Needs assessments are conducted to help organizations identify and address gaps that prevent organizations from being where they desire to be (English & Kaufman, 1975; Witkin & Altschuld, 1995). The results from this study provide direction for [State] Extension to think strategically about how to address trends that cross county borders. State-level leadership should work to provide critical resources to help counties to overcome the challenges and threats identified in this study, particularly when dealing with professional development and funding issues. Although this study was limited to counties within one state, the connections to the literature imply the results may transfer to a broader Extension population. States are encouraged to examine their own programs for common challenges and threats, so that they can take the actions necessary to provide the best possible programming for their communities.

References

- [Authors]. (2009). An analysis of the priority needs for Cooperative Extension at the county level. *Journal of Agricultural Education*, 50(3), 11-21. doi: 10.5032/jae.2009.03011
- [Authors]. (2010). Identifying outcomes from participation in a Cooperative Extension county program review. *Proceedings for the Southern Region Conference of the American Association for Agricultural Education, USA*. Retrieved from http://aaaeonline.org/uploads/allconferences/2-5-2010_130_Final_Proceedings.pdf
- Boyle, P. G. (1981). *Planning better programs*. U.S.A.: McGraw-Hill, Inc.
- Braverman, M. T., & Engle, M. (2009). Theory and rigor in extension program evaluation planning. *Journal of Extension*, 47(3). Retrieved from <http://www.joe.org/joe/2009june/a1.php>
- English, F., & Kaufman, R. A. (1975). *Needs assessment: A focus for curriculum development*. Washington, D. C.: Association for Supervision and Curriculum Development.
- Ferrell, C. C. (2005). *An assessment of the professional development needs of Oklahoma cooperative extension county staff*. (Unpublished doctoral dissertation). Oklahoma State University, Stillwater, Oklahoma.
- Jacob, S., Israel, G. D., & Summerhill, W. R. (1998). Florida Cooperative Extension's county program review process. *Journal of Extension*, 36(4). Retrieved from <http://www.joe.org/joe/1998august/a5.php>
- Lincoln, Y. S., & Guba, E. G. (1985). *Naturalistic inquiry*. Beverly Hills, CA: Sage Publications, Inc.
- McLean, G. N. (2006). *Organization development: Principles, processes, performance*. San Francisco, CA: Berrett-Koehler Publications, Inc.
- Safrit, R. D., & Owen, M. B. (2010). A conceptual model for retaining county extension program professionals. *Journal of Extension*, 48(2). Retrieved from http://www.joe.org/joe/2010april/pdf/JOE_v48_2a2.pdf
- Varea-Hammond, S. (2004). Guidebook for marketing Cooperative Extension. *Journal of Extension*, 42(2). Retrieved from <http://www.joe.org/joe/2004april/tt5.php>
- Witkin, B. R., & Altschuld, J. W. (1995). *Planning and conducting needs assessments: A practical guide*. Thousand Oaks, CA: Sage Publications, Inc.

A Qualitative Approach to Multicultural Intelligences in Agricultural Education

Jonathan A. Tubbs
Agricultural Education
Department of Community and Leadership Development
University of Kentucky
307 Garrigus Building
Lexington, KY 40546-0215
(859) 257-7578
Fax: (859) 257-1164
jonathan.tubbs@uky.edu

Bryan J. Hains
Agricultural Education
Department of Community and Leadership Development
University of Kentucky
507 Garrigus Building
Lexington, KY 40546-0215
(859) 257-7578
Fax: (859) 257-1164
bryan.hains@uky.edu

Stacy K. Vincent
Agricultural Education
Department of Community and Leadership Development
University of Kentucky
505 Garrigus Building
Lexington, KY 40546-0215
(859) 257-7588
Fax: (859) 257-1164
stacy.vincent@uky.edu

A Qualitative Approach to Multicultural Intelligences in Agricultural Education

Introduction/Need for Research

The increase in diversification in the nation's population has transcended into the diversity of student populations within secondary schools (Woods, 2004). Current research shows that in order to effectively facilitate learning in these changing demographics, role models within the school setting; teachers, guidance counselors, administrators; should reflect the diversity within the student population (Warren & Alston, 2007). Yet, census exploitations show that the majority of teachers are Caucasian, middle-class females with limited cross-cultural interactions (Brown, 2004). These cultural contrasts provide a basis for reform in pre-service training.

Agricultural education is changing both demographically and epistemologically, impacting student learning and intrapersonal development creating a need for future agriculture educators to be more competent toward this increasingly diverse youth generation (Warren & Alston, 2007). To train future and current educators in relating to all populations and providing them with an atmosphere of social and identity development; field experience is needed to sensitize them to cultural diversity turn them into capable cross-cultural educators (Bell, 2000).

Theoretical Framework

Based on the literature stated above, both Social and Emotional Intelligence Theories were used to drive the application for course development. Social and emotional intelligences originated from Howard Gardner's Multiple Intelligences (Gardner, 1986). Whereas social intelligence encompasses both social capability and interpersonal consciousness (Goleman, 2006), emotional intelligence represents a set of abilities to better understand emotional responses (Hawkeys, 2006). The deeper the understanding of these emotions leads to better problem solving in a person's emotional life (Hawkeys, 2006).

AED 670: Advanced Methods in Teaching Career and Technical Education and AED 580: Foundations of Teaching Career and Technical Education were the tools utilized to facilitate the research conducted.

The student process for assuming the roles and generating a reflection is outlined below:

- Selected the role
- Preparing for the role play through research resources
- Emotions experienced and catalyst for them
- Overall development as an individual as a result of the experience

Methodology

The research methodology utilized for these courses was qualitative case study (Yin, 1985). The setting included students from two courses, AED 580 ($n = 24$) and AED 670 ($n = 8$). During the experience, students maintained personal journals reflecting the processes of selecting, researching, and enacting identities, and reflecting upon the experiences. Journals were collected then holistically and axial coded (Saldaña, 2009) resulting in thematic categories. The categories were then referenced back to the participants for clarity and confirmation. Resulting themes and supporting information is outlined below.

Results/Findings

Due to page requirements, the following results/findings have been summarized without the inclusion of participant quotes.

Cultivating Cultural Identity: AED 670 Themes

- Students varied in data collection when researching their roles (literature review, observation, interview)
- Discomfort and unease during emersion experience created from being viewed differently
- Student change in perception and attitude and a generation of empathy and understanding toward multicultural intelligences as a result of the emersion experience.

Confronting Cross-Cultural Situations: AED 580 Themes

- Discomfort and unease during experience created from facing challenging cultural situations not previously confronted
- Students challenged at creating an opinion separate from their own for their character during the experience
- Student instilment of empathy and change of opinion within self and a personal and professional growth due to the emersion

Conclusions/Implications/Recommendations/Impact on the Profession

Data showed that through emersion and challenge techniques, cultural understanding takes place and empathy is created. In both courses, students had to become socially intelligent by researching and immersing themselves into foreign cultures, or as they encountered social situations that made them uncomfortable. This also impacted their emotional intelligence as they had to identify their own emotions toward their new identity or social setting, identify emotions felt when enacting their role, and explain their emotions in their reflections.

The constructs of both research frames are not impervious to the human factor. Without establishing rationale and generating a need for the information, students may not take the experiences seriously (Brown, 2004). These experiences will be unfamiliar to most of the students, especially with undergraduates, and may not be viewed as necessary or relevant. It is critical that pre-service agriculture teachers receive training in diversity that prepares them to go beyond knowledge and into application (Talbert & Edwin, 2008).

References

- Bell, L. C. (2000). A Longitudinal Measure of the Perceptual Impact of a Cultural Diversity Teaching Practicum on the Interpersonal Competency of Student Teachers. *Journal of Agricultural Education*, 41(2), 11-18. doi:10.5032/jae.2000.02011
- Brown, E. L. (2004). What Precipitates Change in Cultural Diversity Awareness during a Multicultural Course: The Message or the Method? *Journal of Teacher Education*, 55(4), 325-340. doi:10.1177/0022487104266746
- Gardner, H. (1986). The Theory of Multiple Intelligences. *Annals of Dyslexia*, 37(1), 19-35. doi:10.1007/BF02648057

- Goleman, D. (2006, September). The Socially Intelligent Leader. *Educational Leadership*, 64(1), 76-81
- Hawkey, K. (2006). Emotional Intelligence and Mentoring in Pre-service Teacher Education: a Literature Review. *Mentoring & Tutoring: Partnership in Learning*, 14(2), 137-147. doi:10.1080/13611260500493485
- Saldaña, J. (2009). *The Coding Manual for Qualitative Researchers*. Los Angeles, CA: SAGE Publication, Inc.
- Talbert, B. A., & Edwin, J. (2008). Preparation of Agricultural Education Students to Work with Diverse Populations. *Journal of Agricultural Education*, 49(1), 51-60. doi:10.5032/jae.2008.01051
- Warren, C. K., & Alston, A. J. (2007). An Analysis of Diversity Inclusion in North Carolina Secondary Agricultural Education Programs. *Journal of Agricultural Education*, 48(2), 66-78. doi:10.5032/jae.2007.02066
- Woods, M. D. (2004). Cultivating Cultural Competence in Agricultural Education through Community-Based Service-Learning. *Journal of Agricultural Education*, 45(1), 10-20. doi:10.5032/jae.2004.01010
- Yin, R. K. (1989). *Case Study Research: Design and Methods*. Newbury Park, CA: SAGE Publications, Inc.

**A Qualitative Examination of Successful Collaboration Among Extension Agents
and Agricultural Science Teachers: Examples, Barriers, and Enabling Factors**

Theresa Pesi Murphrey

Assistant Professor
Texas A&M University
Department of Agricultural Leadership, Education, and Communications
MS 2116 TAMU
College Station, TX 77843-2116
979-458-2749
t-murphrey@tamu.edu

John Rayfield

Assistant Professor
Texas A&M University
Agricultural Leadership, Education, and Communications
MS 2116 TAMU
College Station, TX 77843-2116
979-862-3707
jrayfield@tamu.edu

Julie Harlin

Associate Professor
Texas A&M University
Department of Agricultural Leadership, Education, and Communications
MS 2116 TAMU
College Station, TX 77843-2116
979-862-3014
j-harlin@tamu.edu

Kimberley A Miller

Mission Viejo High School
Agriscience Academy
25025 Chrisanta Drive
Mission Viejo, CA 92691
949-837-7722 x5190
Kimberly.Miller@svusd.org

A Qualitative Examination of Successful Collaboration Among Extension Agents and Agricultural Science Teachers: Examples, Barriers, and Enabling Factors

Introduction/Need for Research

Collaboration among Extension agents and Ag Science Teachers has the potential to increase the reach of both organizations to serve clientele. However, successful collaboration requires barriers to be minimized and enabling factors to be maximized. This poster seeks to document best practices of collaboration among agents and teachers across [state].

Theoretical Framework

In order to understand how to encourage collaboration among agents and teachers, one must understand the history of both organizations. The [state] Extension service was founded in 1914 by the passage of the Smith-Lever Act with the purpose to allow the diffusion of current research to the mass populations ([state] State Historical Association, 2009). During the same time period, secondary agricultural education was encouraged through the passage of the Smith-Hughes Act in 1917. As shared by Moore (1988), “the Smith-Hughes Act simply provided federal funds directly to states to continue supporting the teaching of agriculture, established strict guidelines for operation of high school agricultural programs, and made the instruction more vocational” (p. 176). Both organizations serve educational roles within agriculture. Thus, it would seem appropriate that these two organizations collaborate with one another. However, collaboration is not always achieved. A review of literature conducted by Mattessich and Monsey (1992) revealed categories of factors that research has shown can influence collaboration and provides a theoretical base for the study of collaboration in the context of agricultural education and Extension. Nineteen factors, articulated in the study, were grouped into six categories that included: environment, membership characteristics, process/structure, communication, purpose, and resources. The authors shared that each of these categories were identified in the literature as influencing the “success of collaborations formed by human service, government, and other nonprofit agencies” (p. 14). However, while this study provides a wealth of information it does not address the context of agricultural science teachers and Extension agents.

Methodology

The purpose of this poster, as part of a larger study, was to document examples, barriers, and enabling factors shared by agents and teachers who were identified by leaders as successfully collaborating among one another. The study reported here shares results of open-ended questions and a focus group session, examined qualitatively using the constant-comparative method. Purposeful selection of participants was accomplished using a nomination process yielding a total of 33 respondents (15 agents; 18 teachers). A total of 12 (7 agents; 5 teachers) individuals participated in the focus group, which was held approximately two months following completion of the online survey. The four open-ended questions presented at the end of the quantitative instrument included: “Describe specific ways you have been able to collaborate,” “Why do you feel you have been able to collaborate?,” “What barriers exist that may have kept you from collaborating?,” and “Are there additional examples that you could share that exhibit collaboration...or lack of collaboration?” Written responses were coded to maintain confidentiality of the respondents. Open-ended responses were then analyzed by researchers to identify themes, patterns, and categories.

Results/Findings

An evaluation of open-ended responses revealed three primary areas: barriers, enabling factors, and examples. Focus group session responses supported primary areas, but also defined specific areas regarding collaboration, including personal definitions of collaboration, the influence of rural vs. urban settings of both teachers and agents and the influence of former involvement in 4-H or FFA. During the focus group session, agents and teachers were eager to share their personal recommendations to encourage and support collaboration between the groups, including specific recommendations to leaders in both Extension and agricultural education who are in a position to encourage, support and promote collaboration efforts. Aspects that were reported as influencing collaboration included interest and awareness of common program goals, good relationships, attitude, sharing of resources, and friendships. Respondents provided insight into barriers that prevent collaboration. The most commonly listed barrier was time. Additional barriers included: conflict of event dates, wrong people in positions, and personality conflicts, individuals that prefer to work alone, size of county, and weak relationships. One respondent stated, “Some counties do not work together – it is a competition instead of collaboration.” Focus group respondents added lack of communication, fear of change, and inexperience in understanding the benefits of collaboration.

Conclusions

Based on the findings of this study, both agriscience teachers and Extension agents in *[state]* see collaboration as both a necessity and a benefit, not only to each group of adults, but most importantly to the children involved in each individuals’ youth organization. Agents and teachers see collaboration as a method of building lasting professional relationships as well as personal friendships which will further strengthen collaboration efforts. Focus group responses revealed that both teachers and agents agree that seeing collaboration as a team effort will further strengthen relationships and the outcomes of collaborating. A strong voice was heard from both groups in identifying a common purpose and related interests in activities as a motivation to collaborate with one another. When teachers and agents can work together at livestock shows, hauling livestock, leadership activities, conducting workshops, fundraisers or in validation efforts, there is a greater opportunity to work together, build relationships and collaborate professionally. Agents and teachers believe that strong working relationships foster stronger programs and hold greater benefit for children involved.

Implications/Recommendations/Impact on Profession

Agricultural education leaders and Extension agency leaders would benefit from creating activities that introduce the benefit of each group and how each group can complement the others efforts. It is recommended that leaders of the groups investigate scheduling similar activities in ways that benefit both groups. Additionally, it is recommended that in-service or workshops specific to the topic of collaborating with one another for incoming agents/teachers be considered. Training on the benefits of collaborating could be emphasized to help teachers and agents further embrace the concept. Recognizing successful collaboration efforts at county meetings, teacher meetings or banquets can also help promote collaboration among agents and teachers. It is therefore recommended that leaders within these organizations schedule events or seek out appropriate times to recognize positive collaboration efforts or programs that further promote successful work among the organizations.

References

- Mattessich, P. W. & Monsey, B. R. (1992). *Collaboration: What Makes It Work: A Review of Research Literature on Factors Influencing Successful Collaboration*. Minnesota: Amherst H. Wilder Foundation.
- Moore, G. E. (1988). The involvement of experiment stations in secondary agricultural education: 1887-1917. *Agricultural History*, 62(2),164-176.
- [state] State Historical Association. (2009). [state] Agricultural Extension Service. Retrieved December 3, 2009, from <http://www.tshaonline.org/handbook/online/articles/TT/ampw.html>

**Agricultural Science Technology Needs:
Agricultural Science Teachers Facing the Future in the Classroom**

Beth Ann Bills-Hunt
Graduate Assistant
University of Arkansas/ AEED Department

Don W. Edgar
Assistant Professor of Agricultural Education
University of Arkansas/ AEED Department
205 Agriculture Building
Fayetteville, AR 72701
(479) 575-2037 Phone / (479) 575-2610 Fax
dedgar@uark.edu

Leslie D. Edgar
Assistant Professor
University of Arkansas / AEED Department
205 Agriculture Building
Fayetteville, AR 72701
(479) 575-6770 Phone / (479) 575-2610 Fax
ledgar@uark.edu

Kristin Pennington
Graduate Assistant
University of Arkansas/ AEED Department

Allyson McGuire
Graduate Assistant
University of Arkansas/ AEED Department

Casandra Cox
Instructor
University of Arkansas/ AEED Department

Agricultural Science Technology Needs: Agricultural Science Teachers Facing the Future in the Classroom

Introduction / Need for the Research / Conceptual Framework

Postsecondary and secondary education today is a dynamic educational environment as new, electronic technologies and their educational potential emerge. Agriculture as a field of study continues to diversify and change, trying to meet the needs of producers and commodity groups. This change and diversification brings the need to more effectively communicate and promote agriculture to an audience that continues to be further removed from agriculture.

Technological advances, which can support the vitality and longevity of the agricultural industry, are needed. New communication media in agricultural fields have changed the thoughts and ideas of people. However, it is difficult for educators (both secondary and post-secondary) to keep pace with the ever-changing technologies impacting agriculture. The United States Department of Education (US DOE) (1996) defines *technology literacy* as "computer skills and the ability to use computers and other technology to improve learning, productivity, and performance" (§ 2). It listed four goals related to technology literacy that were developed to ensure all students and teachers have equitable access to and effective use of technology:

- "All teachers in the nation will have the training and support they need to help students learn using computers and the information superhighway.
- All teachers and students will have modern multimedia computers in their classrooms.
- Every classroom will be connected to the information superhighway.
- Effective software and on-line learning resources will be an integral part of every school's curriculum" (§ 5).

Educational strategies focused on improving technology literacy and technology in the classroom exists. However, instruction in agricultural communications allows students an understanding and knowledge of electronic technologies and their potential to promote agriculture as a whole. In 2006, the National Research Agenda [NRA]: Agricultural Education and Communication 2007-2010 (Osborne, n.d.) was developed as one of the first collaborative visions linking agricultural education and communications. It is the responsibility of higher education to observe and keep pace with the ever-changing technological advances to prepare students, teachers, and society with the necessary skills that promote all facets of agriculture.

To explain learning, educators must take into account students' thoughts, beliefs, and feelings (Bigge & Shermis, 1999; Gredler, 2005; Schunk, 2004). By capitalizing on the curiosity piqued in secondary students through innovative technology, university faculty can present knowledge content which more fully engages students in specific focus areas and allows them to seek and apply knowledge. Technology literacy can be gained through educational units in electronic communications where students can use technology creatively to tell a story. However, minimal agricultural communications curriculum exists in high schools across the nation. Also, it is unclear the level of technology literacy that exists in secondary schools today.

Purpose and Methodology

The purpose of this study was to assess [state] how agricultural science teachers perceived students' needs for training in electronic communication and technology for secondary students. A literature review preceded the development of the survey, which was piloted tested and checked for content and face validity. Cronbach's Alpha was utilized as a reliability measure for each portion of the survey instrument. Overall the instrument had marginal to good internal consistency (Morgan, Leech, Gloecker & Barrett, 2007). The population of this study was [state] secondary agricultural science teachers ($N=148$). Data was collected using a web-based survey,

and Dillman's (2007) Total Design method was followed. Ninety-five teachers completed the survey; a 64.2% response rate. Non-response error was controlled by comparing early and late respondents (Lindner, Murphy, & Briers, 2001). Utilizing SAS, data were analyzed and descriptive and correlation statistics were reported.

Results and Findings

[State] agricultural science teachers in this sample population ($n = 85$) participated in the technology needs assessment. Total years of teaching experience ($n = 72$) was analyzed and resulted in a mean of 3.89 ($SD = 1.35$). Gender of the participating teachers ($n = 73$) was 80.8% male and 19.2% female. Teachers identified ethnic backgrounds ($n = 73$) into two ethnicities being 91.8% white and 8.2% Native American. Teachers indicated the total number of computers in the classroom ($n = 73$) averaged 2.04 computers ($SD = 1.21$).

Results from the technology needs assessment completed by the agricultural science teachers rated several variables. Mean technology literacy self rating was intermediate or willing to try most technology but not proficient ($n = 75$; $M = 2.04$, $SD = 0.58$) and student technology literacy rating was below an intermediate rating ($n = 74$; $M = 1.86$, $SD = 0.51$). Interest in teaching technology ($n = 73$) resulted in a mean score of 2.23 ($SD = 0.64$) and students' openness to learn using technologies ($n = 73$) indicated a mean score of 2.38 ($SD = 0.62$).

Pearson product moment correlations were utilized to identify significant correlations. Three significant correlations were noted. Technology literacy self rating versus interest in teaching technology correlation was characterized as medium ($r = 0.46$, $p < 0.0001$) (Cohen, 1969). A large correlation was noted between students' openness to learn using technologies and student technology literacy rating ($r = 0.53$, $p < 0.0001$). Total years of teaching experience and interest in teaching technology was a medium relationship ($r = -0.33$, $p < 0.05$).

Conclusions, Implications and Recommendations

Teachers who had more years of teaching experience rated lower in interest in teaching technology. Data further demonstrated that teachers perceived technology abilities by the students as intermediate to proficient; while teachers believed their abilities were intermediate but not proficient. This finding is alarming is today's technological advanced age whereby students and teachers are perceived as not meeting medium proficiency standards (US DOE, 1996). This was further demonstrated in the low rating of openness to learn technology (Bigge & Shermis, 1999; Gredler, 2005; Schunk, 2004). A large relationship was identified between students' openness to learn using technologies and student technology literacy rating. Teachers indicated that students were less literate about technology, but were willing to learn using technologies. However, additional research efforts should be expanded to determine the impact of teaching agriculture sciences using technology (US DOE, 1996).

Further research should be conducted between the significant variables: technology literacy self rating, interest in teaching technology, students' openness to learn using technologies, and student technology literacy rating. With further research, variables of study should be utilized in different audiences in other state(s) or a national study serving the disciples of agricultural education and agricultural communications. Further research will allow for comparisons of teachers in others regions of the nation and effectiveness of technology and/or agricultural communications curriculum.

References

- Bigge, M. L., & Shermis, S. S. (1999). *Learning theories for teachers* (6th ed.). New York: Addison Wesley Longman, Inc.
- Cohen, J. (1969). *Statistical power analysis for the behavioral sciences*. New York: Academic Press.
- Dillman, D. A (2007) *Mail and internet surveys: The tailored design method*. New York: John Wiley & Sons.
- Gredler, M.E. (2005). *Learning and instruction: Theory into practice* (5th ed.). Upper Saddle River, New Jersey: Pearson.
- Lindner, J. R., Murphy, T. H., & Briers, G. H. (2001). Handling nonresponse in social science research. *Journal of Agricultural Education*, 42(4), 43-53.
- Morgan, G. A., Leech, N. L., Gloeckner, G. W., & Barrett, K. C. (2007). *SPSS for introductory statistics, use and interpretation* (3rd ed.). Mahwah, NJ: Lawrence Erlbaum Associates, Publishers.
- Osborne, E. W. (Ed.) (n.d.). *National research agenda: Agricultural education and communication, 2007-2010*. Gainesville: University of Florida, Department of Agricultural Education and Communication.
- Schunk, D. H. (2004). *Learning theories: An educational perspective*. Upper Saddle River, NJ: Pearson.
- United States Department of Education (US DOE). (1996). Executive summary: Archived information. Retrieved November 1, 2010, from <http://www2.ed.gov/about/offices/list/os/technology/plan/national/execsum.html?exp=6>
- Van Hook, C.W. & Tegano, D. W. (2002). The relationship between creativity and conformity among preschool children, *Journal of Creative Behavior*, 36, 1-16.

**AN ANALYSIS OF PERSONALITY TYPES IN AGRICULTURAL LEADERSHIP
PROGRAM PARTICIPANTS**

Allison Britton
Department of Agricultural Education and Communication
University of Florida
P.O. Box 110540
Gainesville, FL 32611-0540
Phone: 352-392-0502 x244
Email: ahbritton@ufl.edu

Dr. Hannah Carter
Department of Agricultural Education and Communication
University of Florida
P.O. Box 110126
Gainesville, FL 32611
Phone: 352-392-1038
Email: hscarter@ufl.edu

AN ANALYSIS OF PERSONALITY TYPES IN AGRICULTURAL LEADERSHIP PROGRAM PARTICIPANTS

Introduction/need for research

Agricultural leadership programs are designed to broaden the horizons of young leaders involved in the agricultural industry through experiences and programs of study. These programs expose participants to leadership skills that cannot be gained through day-to-day operations. Agricultural leadership programs develop leaders who understand the growing changes in society, politics, and cultures (Bolton, 1991). As a result, leadership program participants are better able to lead their organizations and stay competitive in a changing

Personality types are used in agricultural leadership programs to better understand participants' strengths and weaknesses. Assessing personality types helps program directors better tailor programs of study to meet the needs of participants. More tailored programs can mean participants are able to take more away from the experience. In addition to understanding participants' personality types in regards to tailoring leadership programming experiences, many of these programs have specific program objectives in regards to increasing a participant's understanding of people to make them more effective as they work with people who have diverse personality styles (Carter & Rudd, 2000).

Concept or theoretical framework

To analyze personality types of agricultural leadership program participants, the Myers-Briggs Type Indicator® (MBTI®) was used. The purpose of this indicator is to C.G. Jung's theory of psychological types applicable to individual's everyday lives (The Myers & Briggs Foundation, n.d.). Under the Myers-Brigg typology, there are four areas which personality types address – favorite world, information, decisions, and structure. Favorite world focuses on preference of the outer or inner world and is called Extraversion (E) or Introversion (I). Information focuses on accepting basic information or adding and interpreting that basic information. This process can be described as Sensing(S) or Intuition (N). Decisions focuses on using logic and consistency or people and special circumstances when making decisions. This is known as Thinking (T) or Feeling (F). Structure focuses on making quick decisions or staying open to new opinions and information to make the decision. This is known as Judging (J) or Perceiving (P).

Under Myers-Briggs, there are 16 different personality combinations: ISTJ, ISTP, ESTP, ESTJ, ISFJ, ISFP, ESFP, ESFJ, INFJ, INFP, ENFP, ENFJ, INTJ, INTP, ENTP, and ENTJ.

Methodology

The population of this study included participants from six classes of an adult agricultural leadership program. A complete census of participants was obtained. Participants were given the MBTI® instrument in person during their first leadership program session by a trained MBTI® facilitator. The instruments were analyzed by the Center for Applied Psychological Type (CAPT) to determine the MBTI® type for each participant.

Results

A total of 137 participants were analyzed. The most common personality type of participants was Extraversion, Sensing, Thinking, and Judging (ESTJ). ESTJ personality types comprised 28% (n=39) of participants. The individuals categorized under this personality type are considered practical, realistic and matter-of-fact. ESTJ personality types organize projects and people, in an efficient manner in order to complete a task.

The second most common personality type identified in participants was Introversion, Sensing, Thinking, and Judging (ISTJ) which comprised 15% (n=21) of participants. These individuals are practical, realistic and responsible. ISTJ personality types decide logically what should be done and work steadily toward that goal.

The third most common personality type identified was Extraversion, Sensing, Thinking, and Perceiving (ESTP) which comprised 9% (n=13) of participants. These individuals are flexible

The least common personality types were ISFP, INTP, INFP, and ENFJ. These personality types represented only 5% (n=9) of participants.

Overall, all 16 personality types were identified by at least one participant.

Conclusions

Forty-three percent (n=60) of participants in this agricultural leadership program can be categorized as practical and realistic. These individuals work in a logical and organized manner in order to complete a task. This is a reasonable conclusion in that most farmers are practical and realistic and these leadership programs target individuals who are directly involved with agriculture.

The results of this study also show that this particular leadership program does not have a diverse array of participants regarding personality types. This is important in that agricultural leadership programs strive for diversity in age, gender, ethnicity, industry representation and geography, but the results of this study show that over 40% of participants share similar characteristics.

Implications/recommendations/impact on profession

Implications of this research include an evaluation of agricultural leadership programs' application processes. While these programs claim to recruit diverse participants, program directors may need to re-evaluate their screening processes. More emphasis may need to be put on recruiting participants from non-traditional agricultural backgrounds who may have different backgrounds and personality types.

The results of this research can also help program directors better understand personality types of leadership program participants and therefore tailor programs to meet the personality types of participants. For example, for this particular agricultural leadership program has a large percentage of participants who are practical, realistic, and work in an organized and logical manner to complete a task. While this research has shown that participants prefer to work in a certain way, it may be beneficial for educators who are constructing the program's learning opportunities to address the four areas that comprise these personality types, so participants will gain exposure to experiences that are outside their preferred style.

Recommendations for future research in this area should address whether personality types are important in agricultural leadership programs. While many programs use personality tests to better understand participants, how effective are they in this particular field. Do personality tests (i.e. Myers-Briggs) accurately describe individuals and should they continue to be used? Michael (2009) suggests this instrument; in the field of leadership development is not being used in the way in which it was designed. As a result, the validity of personality tests in relation to leadership development may be brought into question.

References

Bolton, E.B. (1991). Developing local leaders: results of a structured learning experience. *Journal of Community Development*, 22(1), 119-143. doi: 10.1080/15575339109489954

Carter, H. S. & Rudd, R. D. (2000). Evaluation of the Florida leadership program for agriculture and natural resources. *Journal of Southern Agricultural Education Research*, 50 (1), 193-199.

Michaels, J. (2009). Using the Myers-Briggs type indicator as a tool for leadership development?

Apply with caution. *Journal of Leadership and Organizational Studies*. Retrieved from:

<http://www.allbusiness.com/educational-services/business-schools-computer/620590-1.html>

The Myers & Briggs Foundation (n.d.). *My MBTI Personality Type – MBTI Basics*. Retrieved from: <http://www.myersbriggs.org/my-mbti-personality-type/mbti-basics/>

Assessing the Impact of an Academic Internship

Mark J. Kistler, Ph.D.
Jackie A. Bruce, Ph.D.

North Carolina State University
Department of Agricultural and Extension Education
Campus Box 7607
Raleigh, NC 27695-7607

(919) 513-2349 (Kistler)
(919) 515-8801 (Bruce)
mark_kistler@ncsu.edu
jackie_bruce@ncsu.edu

Assessing the Impact of an Academic Internship

Introduction/Need for Research

Hornsby and Johnson (1991) state a “lack of practical work experience has long been a problem for college students when their credentials are reviewed during the job search process.” Randall and Good (1991) assert that employers prefer to hire individuals who have work experience. Internships give students an opportunity to learn the mechanics of a job without having to work full-time in the position (Swift & Kent, 1999). As part of the undergraduate curriculum, students are required to complete a semester long academic internship during their senior year as a capstone to their academic program. The purpose of this study was to assess the impact of the academic internship experience on the academic development, personal development, and career direction of former students. This research study addresses the national agricultural education research agenda priority area of *Agricultural Education in University and Postsecondary Settings, RPA 4: Assess the effectiveness of educational programs in agricultural and life sciences.*

Conceptual or Theoretical Framework

Kolb’s (1984) experiential learning model served as the theoretical framework for this study, as well as for the development of the academic internship experience. Kolb believes “learning is the process whereby knowledge is created through the transformation of experience” (p. 38). The model is cyclical, consisting of four learning stages (concrete experience, reflective observation, abstract conceptualization, and active experimentation). Individuals may begin at any stage, but must follow each other in the sequence. The first stage, concrete experience, is where the learner actively experiences an activity (e.g., field work or internship). The second stage, reflective observation, is when the learner consciously reflects back on that experience. The third stage, abstract conceptualization, is where the learner attempts to conceptualize what is observed. The fourth stage, active experimentation, is when the learner is trying to construct ways to modify the next occurrence of the experience. This then leads to the next concrete experience. All of this may happen in a flash, or over a few days, weeks, or months, depending on the subject.

Methodology

This was a descriptive survey research study. Students who interned between the spring of 2007 and the summer of 2009 (N=40) were surveyed. The data collection instrument was researcher developed based on previous literature and was reviewed by a panel of experts for content validity. The instrument consisted of five sections and included both quantitative and qualitative data. Data were collected using an online survey instrument guided by procedures outlined in Dillman’s Tailored Design Method (2000). A total of five contacts were made or attempted (from February 18 - April 23, 2010). Useable responses were received from 29 participants for a 72.50% response rate. Non-response error was controlled by comparing early to late responses and no statistical differences were found. Data were analyzed using SPSS 17.0.

Results/Findings

Former students indicated their internship site supervisor helped them to learn about their position as an intern ($M = 4.69$, where 1 = *No Help at All* to 5 = *Very Helpful*, $SD = .660$) and about the organization for which they were interning ($M = 4.66$, where 1 = *No Help at All* to 5 = *Very Helpful*, $SD = .614$) and were available daily to answer questions, provide direction and feedback. In addition, they responded that the departmental internship coordinator contributed to making the academic internship experience successful by providing advice, direction, and feedback ($M = 4.29$, where 1 = *No Help at All* to 5 = *Very Helpful*, $SD = .854$). Respondents reported the academic internship impacted their career choice ($M = 4.14$, where 1 = *Not at All* to 5 = *Very Much*, $SD = 1.15$) and helped to prepare them for their current career ($M = 3.45$, where 1 = *No Help at All* to 5 = *Very Helpful*, $SD = 1.15$). As a result of the academic internship, respondents also developed their personal and professional skills (22 items including skills such as, oral and written communication, critical thinking, decision making, priority setting, time management, responsibility; Cronbach's alpha: pre-skill = .918, post-skill = .950). They had a pre-skill mean of 3.36 ($SD = .470$) and post-skill level mean of 4.11 ($SD = .476$) which indicates an increase (.753) in skill level (where 1 = *Very Low* to 5 = *Very High*). The paired samples *t*-test resulted in a 2-tailed level of significance less than .01 for the pre- and post-skill level comparison (t -value = 9.81, $df = 28$). This difference is important as shown by the large effect size index of 1.82 (Cohen, 1988). Respondents also indicated the educational components of the academic internship were valuable to their experience ($M = 4.69$, where 1 = *Not Valuable* to 5 = *Very Valuable*, $SD = .660$).

Implications/Recommendations/Impact on Profession

The following are conclusions and implications which impact the profession: 1. Internships influence student's career choice and direction, 2. Supervisors (site and university) provided helpful advice, direction, and feedback, as well as helped to make the internship experience successful, 3. Internships are valued by students for both personal and professional development, 4. Internships develop student's personal and professional skills, 5. Overall, students felt prepared (academically) for their internship, 6. Overall, students were satisfied with their experience and recommended to the department to "keep doing what they're doing."

The following are recommendations for improvement of the academic internship experience: 1. Investigate the development of an internship scholarship to help defray student's financial burden, 2. Work with internship sites to develop a list of potential housing for students, 3. Provide more preparation on working with volunteers and volunteer management (Note: Since the conclusion of this study, a course on the leadership and management of volunteers has been developed and offered), 4. Continue to periodically evaluate the academic internship program for program improvement and impact.

The academic internship is an important educational experience due to its impact on student's personal and professional development by providing an experiential learning opportunity to put theory into practice in a real world setting.

References

- Cohen, J. (1988). *Statistical power analysis for the behavioral sciences* (2nd ed.). Hillsdale, NJ: Erlbaum.
- Dillman, D. A. (2000). *Mail and internet surveys: The tailored design method* (2nd ed.). New York: John Wiley & Sons, Inc.
- Hornsby, J., & Johnson, M. (1991). Developing internships at a university: An intrapreneurial model. *Journal of Education for Business*, 66(3), 155-159.
- Kolb, D. A. (1984). *Experiential learning: Experience as the source for learning and development*. Englewood Cliffs, NJ: Prentice-Hall, Inc.
- Randall, E., & Good, D. (1991). An analysis of marketing internship programs. *Journal of Education for Business*, 66(4), 228-231.
- Swift, C. O., & Kent, R. (1999). Business school internships: Legal concerns. *Journal of Education for Business*, 75(1), 23-26.

Biodiesel Education: Effects on High School Students' Knowledge and Perceptions

Jason A. Davis, Graduate Assistant

jad06@uark.edu

479-575-2035

Department of Agricultural and Extension Education
205 Agriculture Building
Fayetteville, AR 72701

Ryan Siebenmorgen, Graduate Assistant

siebenm@uark.edu

479-575-2035

Department of Agricultural and Extension Education
205 Agriculture Building
Fayetteville, AR 72701

Don Edgar, Assistant Professor

dedgar@uark.edu

479-575-2035

Department of Agricultural and Extension Education
205 Agriculture Building
Fayetteville, AR 72701

George W. Wardlow, Professor and Head

wardlow@uark.edu

479-575-2035

Department of Agricultural and Extension Education
205 Agriculture Building
Fayetteville, AR 72701

Donald M. Johnson, Professor

dmjohnso@uark.edu

479-575-2035

Department of Agricultural and Extension Education
205 Agriculture Building
Fayetteville, AR 72701

BIODIESEL EDUCATION: EFFECTS ON HIGH SCHOOL STUDENTS' KNOWLEDGE AND PERCEPTIONS

The world-wide market for biodiesel is predicted to triple between 2005 and 2015, with total sales estimated at \$52.15 B (Gantz, 2006). Despite the predicted increase in production and sales, Skipper (2007) found a widespread lack of knowledge of biofuels among US consumers; 32.5% had never heard of biodiesel and only 4.2% regularly purchased a biodiesel blend. According to Osius (in Caldwell, 2009), consumer education is the key to enhancing the demand for biofuels.

The theory of reasoned action (Ajzen and Fishbein, 1980) posits that human actions, such as using biodiesel, are guided by three considerations: beliefs about the consequences of an action (behavioral beliefs), beliefs about the normative expectations of others (normative beliefs), and beliefs about the presence of factors that may promote or hinder the behavior (control beliefs).

Regardless of availability, consumers are unlikely to use biodiesel if they perceive it to have negative consequences or if use of biodiesel is not accepted by their peers. Wong, Turner, and Stoneman (1996) concluded that consumer demand is a major factor in triggering the development and widespread availability of green products, including biodiesel. Many consumers are either ill-informed or miss-informed about biofuels, including biodiesel (Skipper, 2007). Educating consumers and policy makers about renewable energy, including biofuels, is one of three primary educational needs necessary to expand the renewable energy market, according to Acker (2008), who specifically recommended that educational programs target industry personnel, the general public, and school groups.

PURPOSE

The purpose of this study was to evaluate a biodiesel education program for public secondary school students. The primary objective was to determine if the educational program was effective in increasing students' knowledge about biodiesel or their perceptions of biodiesel.

The population for this study consisted of secondary school students enrolled in an agricultural education program at (name of high school). Four classes totaling 69 students participated, yielding 65 usable responses. Parental consent forms were obtained for each student.

DESCRIPTION OF EDUCATIONAL PROGRAM

In each class, the program was presented during two 50 minute class periods on separate days. On Day 1, pre-tests were administered followed by an illustrated lecture-discussion lesson on defining biodiesel, describing biodiesel feedstocks and production, understanding ASTM 6751 and BQ9000 quality standards, explaining biodiesel blends and designations, and providing an overview of engine performance and emissions with biodiesel and biodiesel blends.

On Day 2, a trailer-mounted compression-ignition engine equipped with a computer-controlled dynamometer and two auxiliary fuel tanks (on digital platform scales) was used to allow students to collect data on engine performance and specific fuel consumption as the engine operated on ULSD petroleum diesel and a B20 biodiesel blend. These data served as the basis for class discussion of the relative performance of ULSD petroleum diesel and B20. At the conclusion of this discussion, post-tests were administered to the students.

INSTRUMENTATION

The pre-test had three sections: student knowledge about biodiesel, student perceptions of biodiesel, and demographics. The post-test consisted of two sections: student knowledge of biodiesel and student perceptions of biodiesel. On both tests biodiesel knowledge was measured with 16 multiple choice items (four response options) and perception of biodiesel was measured on a Likert-type scale (1 = strongly disagree, 5 = strongly agree). Face and content validity were established for both instruments. Obtained Coefficient alpha (internal consistency) reliability estimates for sections one and two of the pretest were .18 and .76, respectively, and for sections one and two of the post-test, .87 and .89, respectively. The obtained coefficient on section one of the pre-test was consistent with reliance on guessing.

RESULTS

The typical student was male (64.6%), 16 to 18 years old (67.7%), either a junior or senior (63.1%), and generally made either As or Bs in school (75.4%). A significant minority (43.1%) reported that they or their family owned one or more diesel engines.

The mean pre-test biodiesel knowledge score was 5.0 ($SD = 1.98$) correct out of 16 questions (31.2%). This score was not statistically different ($\chi^2 = 0.33$; $p > .05$) from the expected score of 25% correct through random guessing.

The mean post-test biodiesel knowledge score was 10.7 ($SD = 3.38$) out of 16 items (66.7% correct). This score was both significantly different from guessing ($\chi^2 = 14.96$; $p < .0001$) and significantly higher than the mean pretest knowledge score ($t = 13.92$; $p < .0001$). The resulting Cohen's d of 1.73 indicated a large effect size for the educational treatment (Cohen, 1988).

Although students had fairly positive perceptions of biodiesel prior to the educational program ($M = 3.85$, $SD = 0.77$), student perceptions increased significantly on the post-test ($M = 4.16$, $SD = 0.68$), $t = 3.47$; $p < .001$. The Cohen's d of 0.43 represented a moderate effect (Cohen, 1988).

CONCLUSIONS AND IMPLICATIONS

While high school agriculture students in this study had fairly positive attitudes toward biodiesel before this educational intervention, their knowledge levels about the fuel were relatively low. Participating in the lesson resulted in significant gains in knowledge levels about biodiesel. Further, while students held fairly positive perceptions of biodiesel prior to the educational program, participating in the program significantly increased their perceptions of biodiesel.

The most reasonable conclusion from these findings is that while students had positive attitudes toward biodiesel before the educational program, they had little technical knowledge about biodiesel. The educational program resulted in a significant increase in knowledge levels while positively impacting student perceptions.

Based on these results, the biodiesel education program was determined to be successful in increasing both student knowledge and perceptions of biodiesel. However, given that the mean score on the post-test was 67.7%, frequently missed items should be examined to determine if areas in need of improvement in either curriculum or instructional methods can be identified.

REFERENCES

- Acker, D. 2008. Research and education priorities in agriculture, forestry and energy to achieve the 25x'25 renewable energy vision. *NACTA Journal*, 52(1): 55-59.
- Ajzen, I., and M. Fishbein. 1980. *Understanding attitudes and predicting social behavior*. Englewood Cliffs, NJ: Prentice-Hall.
- Caldwell, J. (2007). Consumer acceptance key to biofuels industry future. *Agriculture Online*. Retrieved from <http://www.agriculture.com/ag/story.jhtml?storyid=/templatedata/ag/story/data/1170702926132.xml>. Accessed 16 February 2010.
- Cohen, J. (1988). *Statistical power analysis for the behavioral sciences*. Hillsdale, NJ: Lawrence Erlbaum Associates, Inc.
- Gantz, R. (March 2006). Study finds alternative energy markets poised for growth. *Renewable Fuel News*: p.3.
- Skipper, D. H. (2007). *Consumer attitudes concerning biofuels* (Unpublished master's thesis). University of Arkansas, Fayetteville.
- Wong, V., Turner, W., & Stoneman, P. (1996). Marketing strategies and market prospects for environmentally-friendly consumer products. *British Journal of Management*, 7: 263-281.

**Comparison of Approaches to Assess the Pre-Service Needs of Student Teachers in
Supporting the SAE Portion of Agriculture Education and Demographic Differences that
Impact Student Need**

**Roger Hanagriff, Texas A&M University Kingsville
John Rayfield, Texas A&M University
Lance Keith, West Texas A&M University
Dwayne Pavelock, Sam Houston State University**

**Contact Information:
700 University Blvd. MSC228
Kingsville, Texas 78363
(361-593-3715)
Roger.hanagriff@TAMUK.edu**

An Assessment of the Pre-Service Needs of Student Teachers in Supporting the SAE Portion of Agriculture Education and Demographic Differences that Impact Student Need

Introduction/Need for Research

In the Distinguished Lecture to the American Association of Agricultural Educators (AAAE) in 2005, Gary Moore posed the following question to those in attendance, “In your state, which circle is the smallest?” The three circles being referred to were the traditional three circles depicting the components of a complete agricultural education program: Classroom instruction, FFA and SAE. Ninety-five percent of the audience members, using electronic responders recorded results that indicated that SAE was the smallest sector. Dr. Moore also offered the same issue to those attending the National Association of Supervised Agriculture Educators (NASAE) conference and the results were similar. SAEs are the shrinking share of educational focus and research into this cause is essential to grow the share back to equality (Moore, 2005, 2006).

Conceptual Framework

The focus of SAE’s is not new and continually surfaces as a focus area. Sutphin and Newcomb (1983) reported that 98% of respondents from a national survey of agricultural educators and administrators believe that SAEs should be required of all high school vocational agriculture students. Previous research has linked the educational value of an SAE to student achievement and knowledge (Cheek, Arrington, Carter, & Randall 1994; Dyer & Osborne, 1996). Newcomb, McCracken, Warmbrod, and Whittington (2004) reported that SAEs allow students to apply practices and principles learned in the classroom and develop new skills and abilities while being involved in these projects. Case and Stewart (1985) indicated that students with both ownership and placement SAE projects came from schools with stronger programs. In other words, strong SAE student involvement is linked to strong programs.

Considering the high value of SAEs and concern for their representation in the educational process, it is important to complete needs assessment for student teachers that will prepare them for improving the profession and increase the quality of SAE educational activities. Previous involvement in FFA and choice of academic major may also determine the need for pre-educational program planning.

Methodology

Data was collected in 2009 by inviting all (State) teacher trainer programs to participate in an assessment survey that centered on SAEs and activities related to SAE activities. Four of the eight (State) teacher training universities agreed to participate in this study, which involved 72 student teachers planning to student teach in the coming semester. A Cronbach’s alpha (.80) determined the strength of internal reliability of the survey using ordinal data points.

The survey instrument included one section to measure self-perceived importance and knowledge in basic areas of SAEs. A second section included specific competency questions related to SAEs and recording the experience. Each of these sections were routed to (state) teacher trainers for input and edited to a final version.

In relation to assessment, two approaches were utilized. One assessment approach was to list general areas of pre-service teacher training, and applies the Borich Model for needs assessment

(Borich, 1980) to create mean weighted discrepancy scores (MWDS) to measure pre-service priority needs. A second approach was to score competency questions, which can be ranked and used as a second measure of pre-service educational needs. Analysis of Variance was utilized to determine significant differences in each assessment area by academic major and previous involvement in FFA.

Results/Findings

Student's choices of academic major were mostly general agriculture (41%) with others including animal science (30%), leadership (11%), agriculture mechanics (9%), agribusiness (7%) and horticulture (3). Nearly two-thirds of respondents (63%) were previously active as an FFA member.

Students priority needs by ranked mean weighted discrepancy score were classroom teaching (2.13), research SAEs (2.06), placement SAEs (1.87), exploratory SAEs (1.83), entrepreneurship SAEs (1.74) and FFA development events (1.65). Competency across all 15 questions resulted in a low score of 62% competency across all areas. The 15 questions segmented into discrepancy areas showed fewer competencies in entrepreneurship SAEs (58%) than reported in MWDS values and higher competency in areas of research SAEs (74%).

There were also significant differences in values by academic major for both weighted discrepancy and competency scores. Students choosing academic majors of horticulture and agribusiness reported high discrepancy scores for entrepreneurship and placement aspects of SAEs ($p < .05$), but showed significantly higher scores in competency questions. Previous active involvement in FFA activities was not significantly different in discrepancy or competency values.

Conclusions

This study compares two approaches for needs assessment areas of pre-service teachers for the SAE portion of agriculture education. Self-perceived needs assessment used solely as measure of prioritizing pre-service educational efforts may not be an appropriate measure. This study illustrated that competency scores differed from ranked discrepancy scores. Previous involvement in FFA activities was not found to be significantly different in relation to self perceived student needs or student's knowledge of SAEs, but academic major may offer insight into student pre-service needs. Likely a wider reaching and more in-depth study could validate these initial findings.

Implications

Solely utilizing a commonly used discrepancy model for pre-service teachers may result in a focused effort that creates less than desirable results. Student competency testing may result in more accurate results, which are likely to determine students prepared to enter the profession and address priority needs such as SAEs. The implications from this study are to develop university materials that address needed areas related to SAEs. Addressing these shortcomings prior to even student teaching can increase student success and raise program quality.

References

- Borich, G.D. (1980). A needs assessment model for conducting follow-up studies. *The Journal of Teacher Education*, 31(3): 39-42. Bryant, B. (2003). SAE- an important part of the curriculum. *The Agricultural Education Magazine*, 75(6), 5.
- Case, L.D., & Stewart, B.R. (1985). Teacher influence on the quality of supervised occupational experience. *The Journal of the American Association of Teacher Educators in Agriculture*, 26(2), 2-8.
- Cheek, Arrington, Carter, & Randall (1994). Relationship of Supervised Agricultural Experience Program Participation and Student Achievement in Agricultural Education. *Journal of Agricultural Education*, 35(2), 1-5.
- Dyer, J. E., & Osborne, E. W. (1996). Developing a model for supervised agricultural experience program quality: A synthesis of research. *Journal of Agricultural Education*, 37(2), 24-33.
- Moore, G. (2005). Lecture to the American Association of Agricultural Educators (AAAE) in 2005, September 24-26, Columbus, OH
- Moore, G. (2006). Who is driving the pickup? A call for professional leadership. *Journal of Agricultural Education*, 47(1), 1-5.
- Newcomb, L. H., McCracken, J. D., Warmbrod, J. R., & Whittington, M. S. (2004). *Methods of teaching agriculture* (3rd ed.). Upper Saddle River, NJ: Pearson Education.
- Peterson, R.W. (1971). More clout for vocational education. *American Vocational Journal*, 46(2), 22-25.
- Sutphin, H.D., & Newcomb, L.H. (1983). Positions held by teachers, teacher educators, and state supervisors about selected national issues in agricultural education. *The Journal of the American Association of Teacher Educators in Agriculture*, 24(2), 53-63-.

**Comparison of Participants' Satisfaction Levels of Food Safety Workshops Presented in
U.S. and Mexico**

Brittni H. Drennan, Landi Woolley Campbell & Dr. Todd Brashears
Texas Tech University

Box 42131
Lubbock, TX 79409-2131
806-742-2816

brittni.drennan@ttu.edu
landicampbell@gmail.com
todd.brashears@ttu.edu

Comparison of Participants' Satisfaction Levels of Food Safety Workshops Presented in U.S. and Mexico

Brittini Drennan, Landi Woolley Campbell & Dr. Todd Brashears, Texas Tech University

Introduction

For many years researchers have been attempting to correctly measure satisfaction. By accurately measuring satisfaction levels, curriculum can be developed to better suit students' needs, thus, affecting productivity. Briggs, Vreede and Reinig (2002) stated in some cases, studies that resulted in meeting higher satisfaction levels also produced higher levels of productivity.

The purpose of this study is to compare student overall satisfaction levels and also between the three constructs of satisfaction: perceived net goal attainment, satisfaction with meeting process items, and satisfaction with meeting outcome items. Using the Satisfaction Attainment Theory (SAT), educators can assess curriculum and determine how to present curriculum to meet students' satisfaction levels, which result in higher productivity. The *National Research Agenda for Agricultural Education and Communication* (n.d.) indicates a research priority area of identifying the "appropriate learning systems to be used in nonformal education settings" (p. 14). The SAT is used in this case to influence program development in a nonformal education setting provided the workshop met students' satisfaction.

Theoretical Framework

Satisfaction Attainment Theory (SAT) suggests meeting satisfaction may enable researchers to develop methodologies to increase efficiency and effectiveness in the workplace (Briggs et al., 2002). SAT is a causal model of meeting satisfaction which is directed by four assumptions: 1) individuals have several goals, 2) individuals' goals may create cognitive dissonance or by attaining one goal, another goal becomes unattainable, 3) Perceived Net Goal Attainment (PNGA) complements conscious, set goals, and 4) perception of PNGA and the likelihood of reaching success in accomplishing that goal closely relate to the negative or positive direction of PNGA. If these assumptions are met, programs that produce positive PNGA are very likely to produce increased levels of meeting satisfaction. In this study, the higher participants' satisfaction levels of the workshop, the more willing participants will be of learning from the workshop and putting those skills to practice.

Methodology

The objectives of the study included: 1) describe satisfaction of the workshop presented in Spanish, 2) describe satisfaction of the workshop presented in English, and 3) measure the relationship between the two workshops. The population included a total of 50 employees at two different meat processing facilities who participated in workshops conducted in Puebla, Mexico, and Lubbock, Texas. Workshop participants completed a pretest, followed by the food safety and HACCP workshop. At the conclusion of the workshop, participants completed a posttest and which assessed their satisfaction levels about the workshop. Satisfaction within the three constructs was measured based on the culture in which it was presented. SPSS for Windows was used to calculate the reliability coefficient at .805. The objectives of the study included: 1) describe satisfaction of the workshop presented in Spanish, 2) describe satisfaction of the workshop presented in English, and 3) measure the relationship between the two workshops.

Results

A 7-point Likert scale was used to gauge participants' satisfaction level on 15 questions. Data was analyzed and entered into SPSS 17. The mean and standard deviation were calculated, and correlations were run between groups. The average mean in the first construct, perceived net goal attainment, reported to be slightly higher for the workshop done in Spanish ($M = 6.68$) versus the workshop presented in English ($M = 6.17$). For satisfaction with meeting process items, construct two, respondents in the Spanish group reported a mean of 6.29 within the construct, whereas the English group reported having a lower mean satisfaction level of 6.11. A significant difference was found in the third construct, satisfaction with meeting outcome items. The workshop presented in Spanish showed to meet higher satisfaction levels ($M = 6.54$) than the workshop presented in English ($M = 6.00$). However, no significant difference was found in overall satisfaction between the two groups.

Table 1

Summary of Students' Satisfaction Levels of Food Safety Workshop (N = 52)

	English (n = 30)		Spanish (n = 22)	
	M	SD	M	SD
Construct 1	6.17	1.16	6.68	0.51
Construct 2	6.11	1.03	6.29	0.45
Construct 3	6.00	1.18	6.54	0.53
Overall	6.10	1.08	6.50	0.40

Conclusions

There was a significant difference found in the third construct- satisfaction with meeting outcome items. However, no significant difference was found in overall satisfaction. An independent-sample t test was conducted on students' satisfaction scores to evaluate whether there was a significant difference between the Spanish and English groups. The sample mean of 6.00 ($SD = 1.18$) was significantly different from 6.54 ($SD = 0.53$). The workshop was not interpreted differently between the two groups based on culture. Using the results reported, researchers can better develop curriculum to meet students' satisfaction levels. In a nonformal education setting, the curriculum developed after conducting this study will be more effective. According to Briggs et al. (2002) and the SAT, if satisfaction levels are met, students' productivity will increase.

Recommendations/Implications

There was no significant difference determined in overall satisfaction between the two groups studied, even though a significant difference was observed in the third construct. Additional monitoring of satisfaction levels between groups is recommended for further developing effective curriculum and workshop presentation techniques. Supplementary groups should be evaluated to determine additional basis for differences in satisfaction levels.

References

- Briggs, R. O., Vreede, G. J., & Reinig, B. A. (2002). A theory and measurement of meeting satisfaction. *Proceedings of the 36th Hawaii International Conference on System Sciences 1*, 25c. doi: <http://doi.ieeecomputersociety.org/10.1109/HICSS.2003.1173677>

Osborne, E. W. (Ed.) (n.d.). *National research agenda for agricultural education and communications: 2007-2010*. Gainesville: University of Florida, Department of Agricultural Education and Communication.

Woolley, L. R. (2009). *Evaluation of participants' knowledge and satisfaction scores in an international HACCP workshop* (Master's thesis). Retrieved from <http://dspace.lib.ttu.edu/etd/handle/2346/ETD-TTU-2009-08-59>

Critical Thinking Skills Evidenced in Graduate Student Blogs

Viviana Giraud
giraud523@ufl.edu
University of Florida
PO Box 110540
Gainesville, FL 32611
352-392-0502

Holly Cain
hollykreed@ufl.edu
University of Florida
PO Box 110540
Gainesville, FL 32611
352-392-0502

Nicole Stedman, PhD
nstedman@ufl.edu
University of Florida
PO Box 110540
Gainesville, FL 32611
352-392-0502

Gregory Gifford, PhD
ggifford@ufl.edu
University of Florida
PO Box 110540
Gainesville, FL 32611
352-392-0502

Critical Thinking Skills Evidenced in Graduate Students Blogs

Introduction/need for research

Technology has made an impact on what educators can do and the resources they can use in their classrooms. Blogs are one example of a pedagogical tool appropriate for stimulating student reflection of course content and experiences (Cannon, Stedman & Gifford, 2010). However, little research has been conducted identifying the specific benefits of blogs on student cognitive development. Critical thinking is one area of cognitive development necessary for student success (Halpern, 1990). The objective of this research study was to identify Facione's six critical thinking skills using graduate students blogs as a reflection tool in the context of leadership. Students often learn from reflecting on their past leadership experiences. Reflection using a social media tool like blogging to look at the impacts of critical thinking. Rudd, baker, and Hoover (2000) defined critical thinking as, "a reasoned, purposive, and introspective approach to solving problems of addressing questions with incomplete evidence and information for which an incontrovertible solution is unlikely" (pg. 5).

Theoretical Framework

The Delphi Report (1990) by Peter A. Facione on critical thinking skills was used as a framework for this research. Facione (1990) defined critical thinking as, "purposeful, self-regulatory judgment which results in interpretation, analysis, evaluation, and inference, as well as explanation of the evidential, conceptual, methodological, criteriological, or contextual considerations..." (pg. 2). The Delphi panel of experts consensually agreed on descriptions of the following critical thinking cognitive skills: (1) Interpretation, (2) Analysis, (3) Evaluation, (4) Inference, (5) Explanation, and (6) Self-Regulation.

Gifford (2010) found that when using the "What?, So What? Now What?" model students were more consistent in the quality of reflection in a blog. This study was conducted with undergraduates in a service-learning based course. The goal of the experience was to enhance critical thinking of leadership students through blogs. He recommended that leadership educators continue to integrate technology into the learning experience of students.

The purpose of this research was to identify the frequency and depth of skill used among leadership students in a personal blog. As reported by Halpern (1990), instructors are challenged to make students value "good" thinking and the amount of work necessary to make it happen.

Methodology

This qualitative study was descriptive in nature utilizing content analysis to capture the demonstration of critical thinking skills in graduate students' blogs. According to Lincoln and Guba (1985) this analysis provided researchers an in-depth understanding of the phenomenon of interest. As part of a graduate leadership theory course at a southern land grant institution students were assigned to blog for part of their course grade. The grades were determined by the content of the reflections; yet were not impacted by their specific reflection guidelines. Students were given one of two different options for their blog. The first was directed using guidelines associated with Bloom's (1956) Taxonomy of Learning where students had to address the

following areas: Cognitive Growth, Affective Response, and Behavioral Application. The second group was given only the requirement to reflect on different topics throughout the semester.

Students in the course represented both master and doctoral students from five different specializations within a college of agriculture and life sciences. These were teacher education, leadership education, agricultural communications, extension, and wildlife conservation. A total of 17 students were included in these groups with nine being in the guided reflection group and eight in the open reflection group. Blogs were downloaded from Wordpress.com where students were required to host their blogs. All descriptive information was removed from the blogs prior to be reviewed by two researchers. The researchers were required to review each blog entry for each student evaluating the content for evidence of each of the six critical thinking skills identified by Facione (1990). In order to establish trustworthiness of the study, an audit trail and acknowledgement of the researchers' biases were disclosed. Upon completion of the content analysis, researchers shared their results to determine consistency in evidence.

Results/Findings/Conclusions

Half of the students were given the three learning modes, the other half was not. The students that had the structure, the more conceptual and thorough the blogs were. The top three critical thinking skills used by students were self-regulation, explanation, and interpretation. All blogs were self-regulatory although they were accompanied with another critical thinking skill. In the findings, interpretation and explanation overlapped as well as analysis and evaluation. These pairs were difficult to decipher in the context of the blogs. When analyzing the data, it was often clear if they were using critical thinking skills when reflecting. The unstructured reflections were inconsistent and lacked focus. The structured reflections showed multiple critical thinking skills in one paragraph and elicited deep analogies. Made evident in research, when a student is given specific guidelines, thinking capacity is expounded. The researchers have included samples below. In the following examples it is clear what critical thinking skill is being used:

“Sometimes our perception of what we think we need to answer can skew our results. I believe that because I have become more aware of my issues that I need to work on, I am self-consciously harder on myself than I would have been had I approached this test with no pre-conceived notions.” -Self-regulation, Student 3

“One of the hardest tasks for me through my college career has been my inability to focus on the goal itself not the process that I have to complete. Much of the culprit of the problem has been because I become enamored by the process of the project that must be completed that I forget the real reason on why I am completing the task.” –Explanation, Student 17

“The value of this growth process is that I have learned that strengths and weaknesses can be perceived in different ways, which is why a leader should withhold judgment on others.” - Interpretation, Student 11

Implications/recommendations

Bloggging is used in the classroom as an experiential learning technique providing students with the abilities to think intuitively and reflect on the content. Reflection allows students to draw from past experiences and create relationships that increase critical thinking capacity. Leadership education is relying more on social media to provide an avenue for reflection and provides students the opportunity to share their reflections in an open and safe environment. As Gifford (2010) suggested in his work there needs to be the continued inclusion of these technologies in the classroom. This will enhance student critical thinking especially when students are given specific guidance as to *how* to reflect.

References

- Bloom B. S. (1956). *Taxonomy of Educational Objectives, Handbook I: The Cognitive Domain*. New York: David McKay Co Inc.
- Cannon, K., Stedman, N., and Gifford, G. (2010). *Bloggging as a pedagogical tool*. Proceedings of the 2010 American Association for Agricultural Education Research Conference. Omaha, NE.
- Facione, P.A. (1990). *The Delphi report*. Millbrae, CA: The California Academic Press.
- Gifford, G.T. (2010). A modern technology in the leadership classroom: Using blogs for critical thinking development. *Journal of Leadership Education*, 9(1), 165-172. Retrieved from http://www.fhsu.edu/jole/issues/JOLE_9_1.pdf
- Halpern, D.F. (1990). Teaching for critical thinking: Helping college students develop the skills and dispositions of a critical thinker. *New Directions for Teaching and Learning*, 1999(80), P.69-74.
- Lincoln, Y. S., & Guba, E. G. (1985). *Naturalistic inquiry*. Newbury Park, CA: Sage Publication, Inc.
- Rudd, R., Baker, M., and Hoover, T. (2000). Undergraduate agriculture student learning styles and critical thinking abilities: Is there a relationship? *Journal of Agricultural Education*, 42(3), p. 2-12.

**Differences in the Level of Synthesis of Leadership Life Skills Among
4-H Program Alumni**

Jessica Anderson
Graduate Assistant
Box 7607 NCSU Campus
North Carolina State University
Raleigh, NC 27695
jaander3@ncsu.edu

Jacklyn Bruce
Assistant Professor
Box 7607 NCSU Campus
North Carolina State University
Raleigh, NC 27695
jackie_bruce@ncsu.edu

Differences in the Level of Synthesis of Leadership Life Skills Among 4-H Program Alumni

Introduction/Need for Study

Agriculture leadership is a priority research objective as outlined by the American Association for Agricultural Education's National Agriculture Education Research Agenda. The agenda poses the question, "How can leadership education programs be designed and implemented to increase the leadership capacity of youth, communities, higher education, agribusiness, and allied organizations in domestic and international settings?" (pg. 6).

Leadership life skill development continues to be a major goal of the 4-H Program (Seevers & Dormody, 1995). Miller (1976) defined youth leadership life skill development as the "development of life skills necessary to perform leadership functions in real life" (pg. 2). 4-H has a long history of providing life skills to youth that extend into their adult lives (Radhakrishna, 2005). Many studies have been conducted to determine the role of 4-H on leadership and life skill development (Fitzpatrick, et al., 2005; Radhakrishna, 2005; Boyd, Herring, & Briers, 1992; Ladewig & Thomas, 1987; Goodwin, et al., 2005; Seevers & Dormody, 1995). These studies cumulatively conclude that 4-H members have developed critical life skills through the program. However no studies comparing the life skill development of early program alums (college students) of varying involvement levels in the 4-H program have been conducted.

Conceptual Framework

Many studies exist that examine the level of 4-H participation and its effect on leadership life skill development. Boyd, Herring, & Briers (1992) found that the level of 4-H participation was a significant predictor of leadership life skills development scores among 4-H youth. Heinsohn and Cantrell (1986) concluded that the greatest impact on leadership life skill development would be made by increasing youth involvement in leadership experiences beyond the community club level. Therefore, youth involved in the 4-H program will receive maximum leadership life skill development by having experiences beyond the local level.

Within cognition, learning is divided into six categories from simplest to most difficult: 1) knowledge, 2) comprehension, 3) application, 4) analysis, 5) synthesis, and 6) evaluation (Bloom, 1956). Synthesis is an upper level skill which includes the ability to put parts together to form a new whole, unique communication, set of abstract relations (Boone & Boone, 2005).

Methodology

Erlandson, Harris, Skipper, and Allen (1993) tell us that random sampling is not the preferred method when doing qualitative research because the major concern is not to generalize but to understand nuances. In this case, the context being studied is early (5 or fewer years out) 4-H program alumni. The researchers used purposive sampling to identify potential subjects and recruited at a [university] [student group] meeting. Those data were compared to data previously collected at National 4-H Conference. This study focused on 26 individuals who are 4-H alumni.

Semi-structured interviews were conducted and coded to retain confidentiality. These codes are included in the results section as part of the trustworthiness criteria of confirmability and the audit trail. Data analysis followed the traditional methods of constant comparative analysis described by Glaser and Strauss (1967) for use in naturalistic inquiry. Peer debriefing and member checking was done to help establish the credibility of the research. Findings of this research are part of a larger study done by the researchers (Anderson, Bruce, & Mouton, 2010).

Results/Findings

The researchers found that 4-H alumni who had national-level leadership experiences ("Nationals") synthesized leadership life skills at a higher level than those who had only state (States), or local (Locals) leadership experiences. Skills and competencies at the upper levels of Bloom's Taxonomy--analysis, synthesis, and evaluation--were least prevalent in those 4-H

curriculum at a local level (Sawi & Smith, 1997). Findings are organized into the different statements made about gaining a specific skill from the Nationals, States, and Locals.

Skill Gained	Nationals	States	Locals
On the 4-H Influence	The 4-H experience showed me that agriculture wasn't all about pigs and pickles or cows and cooking...Agriculture is ... a lifestyle for me. It is the person that I am and the person I want to be (I5. 3).	It [4-H] definitely has made me who I am (I3.2).	Well, it's given me a lot. I've learned a lot. Probably more than what I would have learned if I wasn't in 4-H (I2.2).
On Career Choice	I'm studying to be an athletic trainer ... and I think that 4-H motivates you to succeed in life and that has inspired me to work with others so that they can succeed as well (I6. 2).	...when I get out of college, I'm hoping to stay in some type of agriculture related thing and you know 4-H is kind of related to agriculture in general and NC State and so I think that it will have an impact (I6. 2).	I guess it opened my options as far as maybe doing something in the 4-H or extension area (I1.1).
On Mentoring Youth	It is very fulfilling to be a part of youth recognizing their abilities and their talents and being able to use those... through 4-H (I11. 2).	I love working with the younger youth (BI5.4).	So you know the ones that kind of kept with it and stayed through an extended period of time you can really see them growing and what they learned ... (I1.1).
On Confidence	Even though I have some natural confidence in the stuff that I do, I think that 4-H instilled in me a sense of confidence, knowing what I want to do and what I believe in (I11. 1).	It definitely helped me to come out and become more confident in myself. (I4.2).	I guess you could say to go up to speak to other people or to go get people involved in the organization. So, it kind of helped me to open up and blossom into an individual. (I7.2).

Conclusions

The differences between the articulation of experiences between the National Collegiate Facilitator Alumni and the local-level experience alumni were overwhelming. The national-level experience alumni were more forthcoming and descriptive of the leadership life skills that they developed as a result of 4-H programming. On the other hand, the local-level experience alumni were more focused on the actual projects rather than the overall experience or overarching skills gained. Consistent with previous research, those alumni who had 4-H experiences at a national level perceived a higher level of leadership life skill development than those who only had experiences at a local level.

Implications

There is an opportunity for 4-H leaders and Extension agents to encourage 4-Hers to get involved past the local club level to maximize leadership life skill development through 4-H. By making leadership life skill opportunities of a higher level available, 4-Hers will be maximizing the resources that the 4-H program has to offer. Being involved on a higher level is not just about fostering a sense of belonging, but utilizing resources for leadership life skill development.

References

- Anderson, J., Bruce, J. & Mouton, L. (2010). 4-H made me a leader: A college-level alumni perspective of leadership life skill development. *Journal of Leadership Education*.
- Bloom, B. S., Engelhart, M. D., Furst, E. J., Hill, W. H., & Krathwohl, D. R. (1956). *Taxonomy of educational objectives book 1: Cognitive domain*. New York: David McKay Company, Inc.
- Boone, H.N. & Boone, D.A. (2005). ABC's of behavioral objectives- putting them to work for evaluation. Retrieved November 1, 2010 from: <http://www.joe.org/joe/2005october/tt3.php>.
- Boyd, B.L., Herring, D. & Briers, G. (1992). Developing life skills in youth. *Journal of Extension*, 30(4). Available online at: <http://www.joe.org/joe/1992winter/a4.html>.
- Erlandson, D.A., Harris, E.L., Skipper, B.L., & Allen, S.D. (1993). *Doing naturalistic inquiry*. Newbury Park, CA: Sage Publications.
- Glaser, B.G., & Strauss, A.L. (1967). *The discovery of grounded theory*. Hawthorne, NY: Aldine.
- Goodwin, J., Barnett, C., Pike, M., Peutz, J., Lanting, R. & Ward, A. (2005). Idaho 4-H impact study. *Journal of Extension*, 43(4). Retrieved February 23, 2010 from <http://www.joe.org/joe/2005august/a4.php>.
- Ladewig, H., & Thomas, J. (1987). *Does 4-H make a difference?* College Station, TX: Texas A & M University System.
- Miller, R.A. (1976). *Leader/agent's guide: Leadership life skills*. Stillwater: Oklahoma State University.
- National Research Agenda: Agriculture Education and Communication. (2007). Retrieved October 15, 2010 from: http://www.aaaeonline.org/files/researchagenda_longlores.pdf.
- Radhakrishna, R.B. & Sinasky, M. (2005). 4-H experiences contributing to leadership and personal development of 4-H alumni. *Journal of Extension*, 43(6). Retrieved March 2, 2010 from: <http://www.joe.org/joe/2005december/rb2.php>.
- Sawi, G. & Smith, M.F. (1997). Skills and competencies in 4-H curriculum materials. Retrieved November 3, 2010 from: <http://www.joe.org/joe/1997april/a1.php>.
- SeEVERS, B. S., & DORMODY, T. (1995). Leadership life skills development: Perceptions of senior 4-H youth. *Journal of Extension*, [On-line] 33(4). Available at: <http://www.joe.org/joe/1995august/rb1.html>.

**Do They or Don't They? Only their Agricultural Science Teachers Know for Sure:
Secondary Agricultural Science Students and Contextual Learning**

Kirk C. Edney
Texas A&M University
2588 TAMU
College Station, TX 77843-2588
979/845-6654
kc-edney@tamu.edu

Do They or Don't They? Only their Agricultural Science Teachers Know for Sure:
Secondary Agricultural Science Students and Contextual Learning
Introduction

Many of today's high school students learn better in contextual situations. This concept is widely supported by credible entities such as the National Council for Teachers of Mathematics (National Council of Teachers of Mathematics, 1989), the American Association for the Advancement of Science (AAAS, 1990), and the National Research Council (1990, 1996). The National Council of Teachers of Mathematics, in particular, recognizes the importance of learning to apply mathematical tools to solve a widening variety of problems (Seeley, 2004). The National Council of Teachers of Mathematics understands the importance of teaching mathematics in a real-world context (1989). The recent report of the National Mathematics Advisory Panel (2008) indicates that teaching in real-world scenarios improves secondary mathematics achievement issues such as fractions, basic equations, and functions.

Conceptual / Theoretical Framework

Learning of value or interest to the learner is that which helps the learner make sense of his or her surroundings (National Research Council, 1990). This context – appropriate learning allows the learner to link new knowledge and skills with previously acquired knowledge more efficiently. The most effective learners are those who can successfully apply prior learning to new contexts. The SCANS Commission asserts their support of contextual learning as the most effective method of developing many skills needed in the real world (U.S. Department of Labor, 1991). Learning through integrated situations develops problem-solving skills more effectively than methods such as memorization and recitation (Driscoll, 2000).

The National Research Council and the American Association for the Advancement of Science repeatedly emphasize the importance of contextual learning situations, linking content across subject matter disciplines, and encourage opportunities related to mathematics and science and the world of work (American Association for the Advancement of Science, 1990; National Research Council, 1988, 1990, 1996). Problem-solving skills developed through contextual learning situations increase student achievement.

Some of today's students seem to lack what can be called mental mathematics agility. Many students are taught the rules of mathematics, but are not taught applications of mathematics. The content of many exit –level mathematics assessments is composed of approximately equal amounts of Algebra I and Geometry objectives. Many of the most-often missed objectives are those dependent upon students' conceptualization skills (Silvey, 2007).

Learning in context enables students to gather information from different sources to address issues of personal significance and transfer the knowledge developed in the process to future situations (Edwards, 2000). Embedding the knowledge in an authentic context is critical to the situated learning process (Lave & Wenger, 1991). Instructional context has been shown to have significant influence on student achievement in mathematics. Secondary agricultural education serves as that effective instructional context on a daily basis for many students (Shinn, Briers, Christiansen et. al., 2003). For situated cognition and anchoring efforts to be effective for learners, mathematics and science activities must be smoothly imbedded and indistinguishable from specific agricultural curriculum content (Balschweid, Thompson & Cole, 2000).

METHODOLOGY

The data collection method consisted of a written questionnaire administered to students participating in the 2008 State Agricultural Mechanics CDE; there were no early or late responders, and no follow up methods were possible. A total of 109 students on these 29 teams participating in the CDE provided 100 survey instruments. One survey response was discarded

due to the respondent's failure to answer any of the items, resulting in 99 usable survey instruments (90.8%). Data from the usable instruments were analyzed using descriptive and correlational techniques.

RESULTS / FINDINGS

All students had taken at least one agricultural science class. Students may take more than 1 course; many students may have selected more than 1 class on the survey. In excess of 80% of all participants had completed Algebra I, Algebra II, and Geometry; the three mathematics courses taken by the majority of high school students prior to the 4 X 4 requirement ([state] Education Agency, 2007). Slightly less than 1/3 had taken pre-calculus, and less than 1 in 10 reported taking a contextual mathematics course such as Mathematical Models with Applications, which is specifically identified as one an acceptable mathematics course in the current [state] recommended graduation plan ([state] Education Agency, 2007). The majority of respondents indicated having completed Biology I, Chemistry, and Integrated Physics and Chemistry. These represent the most popular science courses prior to the institution of the 4 X 4 graduation plan. The total percentage of students enrolled in the three contextual science courses barely exceeds 20%; agricultural science as a contextual science area, is at a competitive disadvantage. Student course-taking is focused on the three required science courses. Students are seldom encouraged to take contextual science courses. However, the findings suggest that students appear to choose contextual science courses more frequently than contextual mathematics courses.

IMPLICATIONS / RECOMMENDATIONS / IMPACT ON PROFESSION

Current curriculum reform efforts recommend the incorporation of discipline-specific contextual mathematics and science courses as an acceptable component of graduation plans. It is hoped that these courses will actually be contextual, and designed to enhance student learning and problem-solving skills (Suydam, 1990), rather than remedial, and designed to serve as reinforcement classes for end-of-course examinations in science and mathematics.

Implications relative to Mathematical Applications courses may impact a variety of areas. Increased enrollments in courses with contextual frameworks such as Mathematical Applications can result in improved student achievement in mathematics.

Current mathematics and science course sequencing options are excessively prescriptive. Scheduling options lack opportunities for students to enroll in contextual mathematics courses at grade levels where integrated instruction may be more effective. Students would experience significant improvement in overall mathematics, science, and CTE achievement when contextual learning is present across a district's curriculum (Lindner, Edney & Jones, 2003).

The Office of Adult and Vocational Education (OVAE, USDE) should make a stronger case to the Institute for Educational Science (IES) regarding the inclusion of contextual learning research. States continue to struggle with assessments that are effective and rigorous. Contextual learning will continue to be a leading research topic (Osborne, 2006).

REFERENCES

- American Association for the Advancement of Science. (1990). *Project 2061: Science for all Americans*. Washington, DC: Author.
- Balschweid, M., Thompson, G., & Cole, R. (2000). Agriculture and science integration: A pre-service prescription for contextual learning. *Journal of Agricultural Education*, 41(2), 36 – 45.
- Driscoll, M. P. (2000). *Psychology of learning for instruction* (2nd ed). Boston, MA: Allyn and Bacon.

- Edwards, M. C., Leising, J. G., & Parr, B. A. (2002) *Improving student achievement in science: An important role for secondary agricultural education in the 21st century*. Unpublished manuscript, Oklahoma State University, Stillwater, OK.
- Lave, J. & Wenger, E. (1991). *Situated learning: Legitimate peripheral participation*. New York: Cambridge University Press.
- Lindner, J. R., Edney, K., & Jones, T. (2003, December). *Student competencies with graphing calculators and achievement in the Texas FFA agricultural mechanics career development event*. Paper presented at the National Agricultural Education Research Meeting, Orlando, FL.
- National Commission on Excellence in Education. (1983). *A nation at risk. The imperative for education reform*. Washington, DC: U.S. Government Printing Office.
- National Council of Teachers of Mathematics. (1989). *Curriculum and evaluation standards for school mathematics*. Reston, VA: NCTM.
- National Mathematics Advisory Council. (2008). Foundations for success: The final report of the national mathematics advisory council. Washington, DC: U.S. Department of Education. Retrieved March 31, 2008 from the World Wide Web: <http://www.ed.gov/about/bdscomm/list/mathpanel/report/final-report.pdf>
- Osborne, E.W. (Ed.) (n. d.). *National research agenda: Agricultural education and communication, 2007 – 2010*. Gainesville, FL: University of Florida, Department of Agricultural Education and Communication.
- Seeley, C. (2004, October). Hard arithmetic is not deep mathematics. *NCTM News Bulletin*, 1, 2. Retrieved June 10, 2007 from the World Wide Web: <http://www.nctm.org/about/content.aspx?id=918>
- Shinn, G. C., Briers, G.E., Christiansen, J. E., Edwards, M. C., Harlin, J. F., Lawver, D. E., Lindner, J. R., Murphy, T. H., & Parr, B. A. (2003). *Improving student achievement in mathematics; An important role for secondary agricultural education in the 21st century*. Unpublished manuscript. Texas A&M University: College Station, TX.
- Silvey, J. (2007). *Using data to impact instruction*. Mathematics TEKS connections. Kilgore, TX: Region 7 Education Service Center.
- Suydam, M. N. (1990). *Curriculum and evaluation standards for mathematics education*. (Mathematics Education Digest no. 1). Columbus, OH: ERIC Clearinghouse for Science Mathematics and Environmental Education. (ERIC Document Reproduction Service No: ED19630)
- U.S. Department of Labor, The Secretary's Commission on Achieving Necessary Skills. (1991). *What work requires of schools: A SCANS report for America 2000*. Washington, DC: Government Printing Office.

Education in a Technological World: An Analysis of Online Teaching Resources

Bart E. Gill

Texas A&M University

Carla Jagger

The Ohio State University

Andrew Adams

Texas A&M University

Jeremy Falk

The Ohio State University

John Hall

Texas A&M University

Jed Bookman

The Ohio State University

Rachel Valenti

Texas A&M University

Katrina Swinehart

The Ohio State University

131 Scoates Hall

TAMU 2116

College Station, TX 77843

(979) 862-7650

bgill@aged.tamu.edu

Education in a Technological World: An Analysis of Online Teaching Resources

Introduction

Secondary students in the United States currently lag behind their peers in other countries in terms of science and math literacy and lack the skills necessary for today's high-skill workplaces or to meet college entrance requirements (Stone, Alfred, Pearson, Lewis & Jensen, 2007). According to the United States Department of Education (USDE) and the National Center for Educational Statistics (NCES) (2009), 15-year-old United States students were out performed in mathematics and science by students in numerous other countries (USDE/NCES). Currently, in agricultural education STEM (science, technology, engineering, and mathematics) integration is a topic that is being researched. Existing agricultural education curriculum fails to effectively integrate STEM into the lessons or requires teachers to spend additional time in professional development workshops to learn how to utilize new curriculum which successfully integrates STEM. Lesson planning and curriculum design require many hours of labor intensive work to ensure that the content taught aligns with state standards, that dynamic and effective pedagogy is employed, and that the content is relevant to the students' lives. Most teachers are required to perform 'other duties as assigned' which limits their lesson preparation time. Providing online resources for teachers to obtain additional teaching materials and share ideas, allows for more variety within the classroom. But the questions still remain: 1) Are the existing online teaching resources user-friendly and relevant to the curriculum? 2) Do online teaching resources assist teachers in saving time while lesson planning?

Conceptual Framework

The conceptual framework is based around the idea that teachers need resources to effectively teach in their classrooms. In today's society, the World Wide Web is one of the best distribution methods of teaching resources. The characteristics of the teachers, the content of the resource, and ultimately the usability of the site are all factors that influence the frequency at which the online resources are utilized by current educators.

Methodology

Researchers conducted a content analysis of four online teaching resources: *Instructional Architect* (<http://ia.usu.edu>), *Curriki* (www.curriki.org), *The Orange Grove Project* (<http://www.theorange Grove.org>), and *Connexions* (<http://cnx.org>), to determine the strengths, weaknesses, and opportunities of each teaching resource. Students from two universities made up the eight-person research team. One student from each university was randomly assigned one of the four online teaching resources, creating two reviewers per online resource. Once assigned an online teaching resource site each researcher identified the strengths, weaknesses, and opportunities of the online resource. Following the analysis, data was analyzed and emergent themes were identified. Peer reviews were conducted to ensure trustworthiness of the data.

Findings

The **Instructional Architect** (<http://ia.usu.edu>) resource is a project of the National Science Digital Library, which was identified as a strength by the researchers. Other strengths include a vast array of articles (approx. 4, 408) and a separate login for students and teachers. Weaknesses

identified by the researchers included: teachers have to know how to write in html code, some of the links were not functioning, and instructions on creating a new project/lesson were limited.

Curriki (www.curriki.org) is self-identified as a hybrid resource between a curricula site and a wiki, which is considered one of the strengths for the site. Curriki is an interactive site that has built in site tours to assist users along the way and the resources appeared to be created with various learners in mind. However, at first glance Curriki can be confusing and not all of the results are shown when conducting searches. Curriki also allows anyone to upload materials to the site, but the credibility of materials did not appear to be checked. Furthermore, even though Curriki includes materials for nearly every subject taught in the school system, including agricultural education, the core subjects were the only subjects listed on the home page. The opportunities of Curriki appear endless; the site is continuously updated by educators sharing materials with one another, which can allow for variability in the classroom. Because Curriki is a globally used site there are opportunities for members to build relationships and develop contacts from around the world.

The **Orange Grove Project** (<http://www.theorangegrove.org>) possessed an introductory video and a tutorial about how to utilize and contribute to the site. The Web pages loaded quickly and allowed a user to visit many sites in a timely manner. The power search option allows users to search for materials by a specific audience. Researchers identified the Orange Grove Project site as not user friendly. There are too many levels to the site and you cannot tell where to find specific resources, overall the layout is counterintuitive. Also, you can only register on the Web site if you are a Florida teacher. Many opportunities exist with this site: it can be used as a textbook resource, the site could reach a large audience, and if tabs were utilized to expand the content then the site would be more user-friendly.

The **Connexions** (<http://cnx.org>) site was well organized, concise, and easy to understand. The site contained a content tab that allowed for easy linking to the content page. The content page possessed a search engine that allowed the content of the site to be search via eight different categories. Downloadable pdf files were available, once a lesson of interest was identified. According to the researchers the homepage is not inviting and once a topic is identified, an extensive list of numerous resource files related to the content were provided, but the list was difficult to navigate through. When analyzing the materials provided, the researchers noted that there are few to no pre-prepared lesson plans available, just activities. Many opportunities for the site are present. More topics need to be added to the search engine to allow for a more specific search. Because of the massive amount of information included on the site, the site allows teachers of different subject matter to explore what teachers in other subjects are teaching.

Conclusions/Implications/Recommendations

The online teaching resources possess many opportunities to be useful teaching resources for teachers in many different disciplines. Currently, the online teaching resources analyzed in this study, were confusing and difficult to use. Agricultural education was only included in one of the four online resources, as an option in the search engines. Agricultural education, as a profession, should continue to improve upon the current online agricultural education teaching resources that exist. Furthermore, agricultural education should endorse sites which offer effective teaching resources, as well as encourage agriculture teachers to use online resources to share ideas and increase efficiency.

References

Stone, J.R., Alfred, C., Pearson, D., Lewis, M. & Jensen, S. (2007). *Rigor and relevance: A model of enhanced math learning in career and technical education*. University of Minnesota, National Research Center for Career and Technical Education.

United States Department of Education, National Council for Educational Statistics. (2009). *U.S. performance across international assessments of student achievement*. Retrieved from <http://nces.ed.gov/pubs2009/2009083.pdf>

Essential Agricultural Mechanics Skills for Beginning Agricultural Educators: A Delphi Approach

**P. Ryan Saucier
Texas State University
212 Agriculture
San Marcos, TX 78666
(512)-245-3325
ryansaucier@txstate.edu**

**Billy R. McKim
Texas A&M University
229 Scoates Hall
College Station, Texas
(979)-845-0794
BMckim@aged.tamu.edu**

**John D. Tummons
114 Gentry Hall
University of Missouri
Columbia, MO 65211
(573)-884-3213 phone
tummonsj@missouri.edu**

Essential Agricultural Mechanics Skills for Beginning Agricultural Educators: A Delphi Approach

Introduction

The use of school agricultural mechanics laboratories, where students employ learning by doing, is an integral part of many agricultural education programs (Sutphin, 1984). Saucier and McKim (2010) pointed out that a great deal of the instruction of agricultural mechanics course curriculum takes place in the laboratory setting. However, in order to provide a safe and effective learning environment for students, agriculture teachers must be competent and knowledgeable in the areas of laboratory safety, facility management, and technical agricultural mechanics skills (McKim, Saucier, & Reynolds, 2010). Unfortunately, many agricultural educators do not receive adequate pre-service education prior to beginning their teaching careers or after accepting a teaching position (Foster, 1986). Researchers utilized a mailed questionnaire to conduct this Delphi study that identified 23 agricultural mechanics skill areas that are essential knowledge for beginning agricultural educators in [STATE].

Theoretical Framework

Agricultural education laboratories are an essential component of the total secondary agricultural education program (Phipps & Osborne, 1988). The use of school and community laboratories, where students employ “learning by doing” is an integral part of many agricultural education programs (Sutphin, 1984). Hubert, Ullrich, Lindner and Murphy (2003) stated “agricultural education programs offer many unique hands-on opportunities for students to develop both valuable academic and vocational skills” (p. 17). Phipps and Osborne also noted that “the primary objective of agricultural mechanics education is the development of the abilities necessary to perform the mechanical activities to be done in agriculture” (p. 306).

Knowledge and skills associated with agricultural mechanics laboratory instruction and management are essential for agricultural educators who intend to provide a safe and efficient laboratory learning environment for agricultural mechanics students (McKim, Saucier, & Reynolds, 2010; Saucier, Schumacher, Funkenbusch, Terry, & Johnson, 2008). Many studies have indicated that teachers need professional development education in the technical area of agricultural mechanics (McKim, Saucier, & Reynolds, 2010; Saucier, Terry, & Schumacher, 2009). Due to the continued need for quality and current professional development education for teachers (Osborne, 2007) and the nationwide lack of research regarding the agricultural mechanics professional development needs of agricultural education teachers, the need for this study was warranted.

Methodology

The purpose of this Delphi study was to determine the essential agricultural mechanics skill areas that beginning [STATE] agricultural educators should possess prior to teaching school-based agricultural education.

1. Determine the essential agricultural mechanics skill areas that beginning [STATE] agriculture educators should possess prior to starting a career in teaching as reported by a panel of experts.

The population for this study were [STATE] agricultural educators with expertise in agricultural mechanics instruction and curriculum ($N = 24$). These teachers were identified by district supervisors and the professional development specialist from the [STATE] Department of Education. Contact information was attained from the 2008-2009 [STATE] *Agricultural Education Directory* ([STATE] Department of Education, 2008).

The data collection process for a Delphi study consists of a series of four questionnaires (Issac & Michael, 1987). The Delphi technique begins with the identification of group members whose consensus opinions are sought. These group members are commonly known as a panel of experts. They are identified due to their expert knowledge in the subject matter being studied. Following four rounds of the Delphi technique, group consensus identified and ranked 23 essential agricultural mechanics skill areas for beginning [STATE] agricultural educators.

Findings

A panel of experts identified the following agricultural mechanics skill areas (ranked from 1 to 23): laboratory safety, methods used to teach agricultural mechanics, laboratory management, measurement tools, project management, Shielded Metal Arc Welding (SMAW), handheld power tools, Oxygen/Acetylene Cutting (OAC), stationary power tools, Gas Metal Arc Welding (GMAW), building material management, carpentry, hand tools, electricity, Plasma Arc Cutting (PAC), Oxygen/Acetylene Welding (OAW), cold metalwork, small gas engines, concrete, plumbing, Gas Tungsten Arc Welding (GTAW), surveying, and soldering.

Conclusions, Implications, and Recommendations

A panel of expert [STATE] agricultural education teachers, who specialize in the instruction of agricultural mechanics, identified 23 essential skill areas within the realm of agricultural mechanics curriculum that beginning [STATE] agriculture teachers must possess prior to beginning a career in secondary education. These skill areas ranged from basic hand tool use to complex welding processes.

The identification of these agricultural mechanics skill areas and the current nationwide lack of research in the area of teacher education/ agricultural mechanics education have led to the development of the following implicative questions: Do current [STATE] school-based agricultural educators have professional development needs in the area of agricultural mechanics? Do agriculture teacher pre-service programs in [STATE] provide technical skill acquisition education for students in these agricultural mechanics skill areas? The answers to these questions may be grounds for future research.

According to the *National Research Agenda for Agricultural Education and Communication* (Osborne, 2007), teachers should be provided with professional development education opportunities at all levels. Based upon the results of this study, teacher educators and state supervisory staff in [STATE] should evaluate their role in preparing fully qualified teachers in the area of agricultural mechanics and ensure that new teachers are ready to assume their roles as school-based agricultural educators in [STATE]'s agricultural education programs.

References

- Foster, R. (1986). Anxieties of agricultural education majors prior to and immediately following the student teaching experience. *In Seeking Solutions for Tomorrow's Challenges: Proceedings of the Thirteenth Annual National Agricultural Education Research Meeting. Dallas, TX*, 34-40.
- Hubert, D., Ullrich, D., Lindner, J., & Murphy, T. (2003). An examination of Texas agriculture teacher safety attitudes based on a personal belief scale from common safety and health practices. *Journal of Agricultural Systems, Technology and Management*, 17.
- Issac, S. & Michael, W.B. (1987). *Handbook in research and evaluation* (2nd ed.). San Diego, CA: EdITS Publishers.
- McKim, B.R., Saucier, P.R., & Reynolds, C.L. (2010). Laboratory management in-service needs of Wyoming secondary agriculture teachers. Paper presented at the 2010 American Association for Agricultural Education Conference, USA.**
- [STATE] Department of Education. (2008). *2008-2009 [STATE] Agricultural Education Directory*. [CITY], [STATE]: [STATE] Department of Education.
- Osborne, E. W. (Ed.) (2007). *National research agenda: Agricultural education and communication, 2007-2010*. Gainesville, FL: University of Florida, Department of Agricultural Education and Communication.
- Phipps, L. J., & Osborne, E. L. (1988). *Handbook on agricultural education in the public schools*. Danville, IL: Interstate Printers and Publishers.
- Saucier, P.R., & McKim, B.R. (2010). Agricultural mechanics laboratory management professional development needs of Texas agricultural education student teachers. Paper presented at the 2010 Association for Career and Technical Education Conference, USA.**
- Saucier, P. R., Schumacher, L. G., Funkenbusch, K., Terry, Jr. R., & Johnson, D. M. (2008). Agricultural mechanics laboratory management competencies: A review of perceptions of [STATE] agriculture teachers concerning importance and performance ability. *2008 Proceedings of the Annual International Meeting of the American Society of Agricultural and Biological Engineers, USA*.
- Saucier, P.R., Terry, Jr. R, & Schumacher, L. G. (2009). Laboratory management in-service needs of [STATE] agriculture educators. *2009 Proceedings of the Southern Region of the American Association for Agriculture Education Conference, USA*, 176-192.
- Sutphin, H. D. (1984). SOE: Laboratories. *The Agricultural Education Magazine*, 56(10), 4.

Evaluating WLC Participants Perceived Knowledge of Authentic Leadership

Chaney Mosley
Virginia Tech
2270 Litton Reaves Hall
Blacksburg, VA 24061
540-231-6836
cmosley@vt.edu

Thomas W. Broyles
Virginia Tech
268 Litton Reaves Hall
Blacksburg, VA 24061
540-231-8188
tbroyles@vt.edu

Whitney Danker
National FFA Organization
6060 FFA Drive
P.O. Box 68960
Indianapolis, IN 46268
wdanker@ffa.org

Lindsey Thomas
Virginia Tech
2270 Litton Reaves Hall
Blacksburg, VA 24061
540-231-6836
lindsrt@vt.edu

Stephen Edwards
Virginia Tech
2270 Litton Reaves Hall
Blacksburg, VA 24061
540-231-6836
swe1979@vt.edu

Evaluating WLC Participants Perceived Knowledge of Authentic Leadership

Introduction/Need for research

Summer youth leadership programs, such as the Washington Leadership Conference (WLC), address, support, and advance positive growth in participants (Henderson, Whitaker, Bialeschki, Scanlin, & Thurber, 2007). In 2006, a task force convened to recommend changes for WLC (National FFA Organization, 2006). Amongst the recommendations were the need for evaluating objectives, measuring program success, and adopting a policy for student readiness that only allowed students entering the 11th or 12th grade to participate. Since 2006, methods for evaluating program objectives and measuring success of WLC have been implemented; however, the National FFA Organization did not establish a policy regarding student readiness. The need for research is based on two premises. First, there have been no measures of whether or not the changes made were effective. Second, according to the National Research Agenda, addressing how student participation in agricultural education programs contributes to premier leadership, personal growth, and career success is a priority research area (Osborne, 2007). This study was guided by the following research questions: What is the effect of participation in WLC on student knowledge and understanding of authentic leadership? What is the effect of grade level on student knowledge and understanding of authentic leadership? Lastly, what is the effect of Net Promoter Score (NPS) on student knowledge and understanding of authentic leadership?

Conceptual Framework

WLC curriculum aims to develop students into authentic leaders. Authentic leaders are “deeply aware of how they think and behave” (Avolio, Luthans, & Walumba as cited in Avolio & Gardner, 2005, p. 321), and are true to themselves, find motivation from within, are original, and their actions are based on personal morals and convictions (Avolio & Gardner, 2005). Authentic leadership curriculum often integrates service based learning activities, where community projects are experiential learning experiences (Furco, 1996). Service learning provides an opportunity for the development of authentic leadership.

Methodology

Participants in the 2010 WLC completed an instrument about their experience. The instrument was distributed on the last night, within four hours of the conference ending. The instrument consisted of five sections: Net Promoter Score (NPS), demographics, session usefulness, knowledge, and group leader evaluation. For the purpose of the research, only NPS, demographics, and knowledge of authentic leadership sections were used. NPS is a standard for determining customer loyalty, developed by Satmetrix (2009). The score was determined by asking the question “How likely is it that you would recommend WLC to another FFA member or FFA advisor?” with participants assigning a score on a 0-10 scale (0 = not at all likely, 10 = extremely likely). Responses were categorized based on their rating, Promoters (9-10 rating), Passives (7-8 rating), and Detractors (0-6 rating) (Satmetrix, 2009). The percentage of detractors is subtracted from the percentage of promoters to calculate the NPS (Satmetrix, 2009). Demographics collected included age, gender, grade level, ethnicity, and where lived. In the knowledge section of the evaluation, students reported agreement with nine statements reflecting knowledge prior to attending WLC and after attending WLC on a Likert-Type scale ranging from 1-7 (1= strong disagree, 7=strongly agree). Cronbach’s alpha =0.85 was calculated for the instrument. Data were analyzed using matched pairs T-test and Analysis of Variance.

Results

RQ1: What is the effect of participation in WLC on student knowledge and understanding of authentic leadership? Knowledge of authentic leadership was measured using nine questions (Table 1). Prior to attending WLC and after attending WLC, means from all nine questions were statistically significant.

Table 1
Means Comparison of Prior to and After attending WLC

Statement	Prior to WLC		After WLC	
	<i>M</i>	<i>SD</i>	<i>M</i>	<i>SD</i>
I know people need me.	4.00	1.83	6.67 *	0.8 4
I understand that living with purpose means to make a conscious decision to use my abilities, responsibilities, and opportunities to impact the world.	3.69	1.53	6.67 *	0.7 8
I realize my community is more than my hometown. It is my town, county, state, nation and world.	3.35	1.77	6.66 *	0.8 3
I know what it means to be an authentic leader who knows their purpose, values, people, takes action and serves others.	3.34	1.40	6.63 *	0.6 9
I know there is a need I can help meet in my community.	3.93	1.67	6.62 *	0.8 8
I can apply the steps to developing a community service project.	3.05	1.59	6.49 *	0.9 1
I have a specific plan of action on how I can make a difference in my community.	2.56	1.62	6.49 *	0.9 7
I can identify the resources I need to carry out a service project.	3.19	1.64	6.44 *	0.9 1
I live with purpose daily.	3.51	1.70	6.31 *	0.9 8

Note. N=1482. Scale was 1=strong disagree, 7=strongly agree. * $p < .05$.

RQ2: What is the effect of grade level on student knowledge and understanding of authentic leadership? There were no statistically significant differences in knowledge of authentic leadership questions after attending WLC by grade level of the participants.

RQ3: What is the effect of NPS on student knowledge and understanding of authentic leadership? There was a statistically significant difference, $F(2,1422)=17.46$, $p < .0001$, on the question “I know what it means to be an authentic leader...” of NPS. Promoters mean score was greater than passives.

Conclusions

Based on the data, the following conclusions were made: (a) participating in WLC increased student perceived knowledge of authentic leadership; (b) grade level does not impact student perceived knowledge of authentic leadership, and (c) students who are more likely to promote WLC had a higher degree of knowledge on authentic leadership.

Recommendations

Based on the conclusions, the following recommendations were made: (a) the curriculum for WLC is written for students entering the junior or senior year in high school; however, the conference experience is valuable for FFA members entering the freshman and sophomore year of high school as well, (b) replicate the study with future WLC participants to validate results, and (c) investigate how promoters encourage other students to attend WLC.

References

- Avolio, B. J., & Gardner, W. L. (2005). Authentic leadership development: Getting to the root of positive forms of leadership. *The Leadership Quarterly*, 16(3), 315- 338.
doi:10.1016/j.leaqua.2005.03.001
- Furco, A. (1996). Service-learning: A balanced approach to experiential education. In *Expanding boundaries: Serving and learning*. Edited by J. Raybuck and B. Taylor. Washington, D.C.: Corporation for National Service.
- Henderson, K. A., Whitaker, L. S., Bialeschki, M. D., Scanlin, M. M., & Thurber, C. (2007). Summer camp experiences: Parental perceptions of youth development outcomes. *Journal of Family Issues*, 28(8), 987-1007.
- National FFA Organization. (2006). *WLC task force final report*. Indianapolis: National FFA Organization.
- National FFA Organization. (2010). *Washington leadership conference*. Retrieved from <https://www.ffa.org/events/conferences/WLC/Pages/default.aspx>
- Osborne, E. W. (Ed.) (2007). *National research agenda: Agricultural education and communication, 2007-2010*. Gainesville: University of Florida, Department of Agricultural Education and Communication.
- Otis, M. D. (2006). Youth as engaged citizens and community change advocates through the Lexington Youth Leadership Academy. *Journal of Community Practice*, 14(1), 71-88.
doi: 10.1300/J125v14n01_05
- Satmetrix. (2009). *Net promoter: The new standard for measuring customer loyalty*. San Mateo, CA: Satmetrix Systems, Inc.

**Exploring Teaching Efficacy of Pre Service Teachers Following the Student Teaching
Internship Experience**

Bart E. Gill

Graduate Assistant
Texas A&M University

T. Grady Roberts

Associate Professor
University of Florida

Tim Murphy

Professor
Texas A&M University

Texas A & M University
TAMU 2116
College Station, TX 77843-2116
979-862-7650
bgill@aged.tamu.edu

Exploring Teaching Efficacy of Pre Service Teachers Following the Student Teaching Internship Experience

Introduction

The student teaching internship experience is an important element of a teacher education program (Deeds, Flowers, & Arrington, 1991; Edwards & Briers, 2001; Harlin, Edwards, & Briers, 2002; Norris, Larke, & Briers, 1990). Experiences that teachers have early on in their teaching career or before they enter the teaching profession contribute to their decision to join and/or remain in the profession (Knobloch & Whittington, 2002; Myers & Dyer, 2004). According to Knobloch and Whittington (p.1), “novice teachers who exhibit a higher sense of efficacy are more likely to persist and remain in the profession”. Self efficacy can be defined as “...a person’s beliefs about their abilities to be successful in a given situation” (Roberts, Harlin, & Ricketts, 2006 p. 82). More specifically, teacher efficacy “...is a judgment of his or her capabilities to bring about desired outcomes of student engagement and learning...” (Tschaanen-Moran & Woolfolk Hoy, 2001). According to Bandura, Barbaranelli, Caprara, and Pastorelli (2001, p. 187), “perceived self efficacy, is...posited as a pivotal factor in career choice and development”.

Conceptual and Theoretical Framework

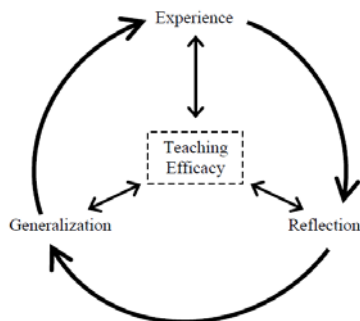

Figure 1. Conceptual Model to Study Teaching Efficacy during the Student Teaching Semester (Roberts, Harlin, & Ricketts, 2006)

The theoretical framework of this study is embedded in the social cognitive theory, which states that people are self organizing, proactive, and self-regulating agents of their psychosocial development (Bandura, 1997). Moreover, the study utilizes the conceptual model to study teaching efficacy during the student teaching semester (Figure 1) proposed by Roberts, Harlin, & Ricketts (2006), which combines teaching efficacy theory and experiential learning theory.

Purpose

The purpose of this study was to determine the teaching efficacy of pre service teachers, at a southern university, following the student teaching internship experience.

Methodology

This study consisted of all student teachers from spring 2008 and spring 2009 semesters at a southern university ($N = 39$). Data were collected immediately following conclusion of the twelve-week internship at a regularly scheduled face to face meeting from each group of student teachers. Teaching efficacy was captured using the *Teachers’ Sense of Efficacy Scale* (often referred to as the *Ohio State Teacher Efficacy Scale*). Data were analyzed using the Statistical Package for the Social Science (SPSS 16.0). Means were reported and compared. The results of this study are only applicable to the participants of the study.

Results/Findings

Overall pre service teachers believe they have some influence, to a great deal of efficacy following the student teaching experience. On a summated scale of 1 (nothing) to 9 (a great deal) the means for all statements were all higher than six. Pre service teachers have the strongest belief that they can make their expectations clear about student behaviors ($n = 39, M = 7.62, SD = 1.25$). Pre service teachers have the weakest belief that they can assist families in helping their children do well in school ($n = 39, M = 6.49, SD = 1.55$).

When comparing different variables: gender, single pre service teacher vs multiple pre service teacher placement, and number teachers within the cooperating schools, there were no significant differences found in the pre service teachers efficacy beliefs. Although none of the group means were found to be statistically different by t-tests, differences between several of the mean scores were observed. The mean score for males ($n = 14, M = 7.57, SD = 1.222$) was slightly higher than females ($n = 25, M = 6.60, SD = 1.35$) in relation to their ability to respond to difficult questions. Furthermore, the mean scores for males ($n = 14, M = 7.36, SD = 1.34$) were slightly higher than females ($n = 25, M = 6.56, SD = 1.26$), in relation to their ability to keep a few problem students from ruining an entire lesson. When comparing pre service teachers that were placed at a cooperating site alone to pre service teachers who were placed at a student teaching site with one of their peers, it can be observed that pre service teachers placed in cooperating sites with a peer ($n = 25, M = 6.80, SD = 1.32$) had slightly higher mean scores in relation to their ability to assist families in helping their children do well in school than pre service teachers who were placed alone ($n = 14, M = 5.93, SD = 1.82$) in a cooperating teaching site. The number of agricultural science teachers, cooperating teachers, within in department had no influence on pre service teachers teaching efficacy scores.

Conclusions

Pre service teachers believe they are very efficacious in relation to their teaching abilities. This was consistent with previous research in agricultural education (Knobloch & Whittington, 2002; Roberts et al., 2006). The undergraduate pre service teacher curriculum coupled with the student teaching internship experience seems to be sufficient in developing pre service teachers' teaching efficacy.

Implications & Recommendations

Teacher educators at the southern university should continue to utilize the current system of pre service teacher placements. The current pre service teacher curriculum is accomplishing its goals of preparing efficacious teachers to enter the agricultural science teaching profession; therefore little change should be made to the curriculum. Although statistically significant differences were not observed, the differences between male and female teachers, along with the differences between pre service teachers placed alone and those placed with peers are interesting to note. These phenomena should be investigated with other samples of pre service teachers to further explore this issue. Additionally, a follow up longitudinal study should be conducted with the sample group to evaluate their teaching efficacy following their first and second year of teaching.

References

- Bandura, A. (1997). *Self-efficacy: The exercise of control*. New York: W. H. Freeman.
- Bandura, A., Barbaranelli, C., Caprara, G. V., & Pastorelli, C. (2001). Self-efficacy beliefs as shapers of children's aspirations and career trajectories. *Child Development, 72*, 187–206.
- Deeds, J. P., Flowers, J., & Arrington, L. A. (1991). Cooperating teacher attitudes and opinions regarding agricultural education student teaching expectations and policies. *Journal of Agricultural Education, 32*(2), 2-9.
- Edwards, M. C., & Briers, G. E. (2001). Cooperating teachers' perceptions of important elements of the student teaching experience: A focus group approach with quantitative follow-up. *Journal of Agricultural Education, 42*(3), 30-41.
- Harlin, J. F., Edwards, M. C., & Briers, G. E. (2002). A comparison of student teachers' perceptions of important elements of the student teaching experience before and after an 11-week field experience. *Journal of Agricultural Education, 43*(3), 72-83.
- Knobloch, N. A. & Whittington, M. S. (2002). Novice teachers' perception of support, teacher preparation quality, and student teaching experience related to teacher efficacy. *Journal of Vocational Education Research, 27*(3), 331-341.
- Myers, B. E., & Dyer, J. E. (2004). Agriculture teacher education programs: A synthesis of the literature. *Journal of Agricultural Education, 45*(3), 44-52.
- Norris, R. J., Larke, A., Jr., & Briers, G. E. (1990). Selection of student teaching centers and cooperating teachers in agriculture and expectations of teacher educators regarding these components of a teacher education program: A national study. *Journal of Agricultural Education, 31*(1), 58-63.
- Roberts, T.G.; Harlin, J.F.; & Ricketts, J.C. (2006). A longitudinal examination of teaching efficacy of agricultural science student teachers. *Journal of Agricultural Education, 47*(2), 81-92.
- Tschannen-Moran, M., & Woolfolk Hoy, A. (2001). Teacher efficacy: Capturing an elusive construct. *Teaching and Teacher Education, 17*, 783-805.

**Knowledge and Perceptions of Agriculture in
Tennessee through Fall Agritourism**

Mrs. Jessica J. Poore
University of Tennessee, Knoxville
2621 Morgan Hall, 202
Knoxville, TN 37996
Phone: 865-974-7372
Fax: 865-974-7383
jjarrell1@utk.edu

Dr. Bryan Q. Patterson
University of Tennessee, Knoxville
2621 Morgan Hall, 320
Knoxville, TN 37996
Phone: 865-974-7371
Fax: 865-974-7383
patterbq@utk.edu

Knowledge and Perceptions of Agriculture in Tennessee through Fall Agritourism Experiences

Introduction

Determining the public's perception of the agriculture is vital to the success of the industry. Agritourism venues bridge the education gap between producers and consumers of agricultural products, by bringing those visitors to their farms. Agritourism is defined for this study as an activity, enterprise or business which combines the agriculture industry and tourism and provides an experience for visitors (Bruch & Holland, 2004). Approximately 44 million respondents to a USDA survey published in, *Agritourism in Focus: A Guide for Tennessee Farmers* agreed that learning where food comes from was "important" or "somewhat important" in their decision to visit agritourism venues. Additionally, 41 million respondents agreed that watching or participating in farm activities was "important" or "somewhat important" to overall knowledge of agriculture (Bragg, Bruch, Hankins, McDaniels, Prather, Winchester, Ziehl, 2005). The aforementioned study supports the notion that agritourism experiences can enhance the public's general knowledge of agriculture. This study examines visitors' knowledge and perception of agriculture before and after visiting one of four agritourism venues in the state of Tennessee.

Theoretical Framework

Intelligence is a process of learning after having an experience with the given environment one is to develop knowledge about. Experiential Learning Theory suggests that experience, perception, cognition, and behavior all play a vital role in one's ability to acquire knowledge and change perception (Kolb, 1984). Four elements work together to create Kolb's Lewinian Experiential Learning Model used to evaluate experiential learning. The four steps of the model (concrete experience, observations and reflections, formation of abstract concepts and generalization, and testing implications of concepts in new situations) best describe the significance of experience as teacher followed by reflection for growth and learning.

The theory states that experiences that provide the learner with new knowledge must be tied to previous knowledge and experience through reflection in order to be of the most benefit to the learner (Merriam, Caffarella, Baumgartner 2007). In terms of experiential learning, education must be looked at as a process. Therefore both experience and reflection are crucial for learning to occur.

Assessing learning in this study is approached in two dimensions; behaviorist learning theory and constructivist learning theory approaches. Behaviorist learning views learning as a change in behavior and seeks to produce that change. Furthermore, the constructivist learning approach challenges the learner to develop a meaning from experience and to construct new knowledge, as in this study relating to the agriculture industry (Merriam, Caffarella, Baumgartner, 2007). Therefore for the purpose of this study, learning will be defined as the construction of new knowledge which can empower the learner to make behavioral changes in lifestyle pertaining to agriculture.

Methodology

The survey population consisted of visitors to fall agritourism venues in the state of Tennessee. Four farms were utilized from a random selection of eleven suggestions provided by the

Tennessee Department of Agriculture. One farm from each grand division of the state was chosen with the exception of East Tennessee where surveys were delivered to two farms (one being the farm where an initial pilot study occurred in fall of 2009). A pre/post survey was utilized. Adult visitors to the farm were asked to complete a five question pre-survey prior to their farm experience. Respondents provided either mailing or email address as post survey contact information. A post survey consisting of 20 questions was mailed approximately three weeks after initial survey response time had ended. The survey questions were designed to collect demographic information, initial perceptions of agriculture, knowledge of agriculture and evaluation of the learning experience. Questions were then ranked on a Likert scale; with responses, “strongly disagree”, “disagree”, “no opinion”, “agree” and “strongly agree”. In addition, closed-ended questions and three open-ended questions comprised the post survey. The results were summarized using descriptive statistics including means, percents, averages and casual-comparative or ex post facto design was employed to accomplish correlation comparisons between the two sets of data.

Results/Findings

The findings support the idea that experiential education is present at the agritourism venues in Tennessee. Knowledge, in almost all cases increased positively due to the visits and experiences at these agritourism venues. Pre-survey analysis shows a strong percentage of visitors are not confident in the safety of the United States food supply. However, they do believe that farm visits are educational and could change their opinion. Approximately 78% would recommend their on farm experience to others. Nearly 94% “agreed” or “strongly agreed” that agritourism visits were educational and provided a valuable learning experience.

Conclusions

Agritourism has a great opportunity to impact consumer knowledge of the overall agriculture industry and can help to create a more positive perception. Through experiences visitors can form new knowledge and dispel common misconceptions. Participants who have hands-on experiences were allowed to reflect on that learning process which proved to be significant. Agritourism appears to have positively influenced consumer knowledge and/or perception of the agriculture industry through the on-farm experiences.

Implications/Recommendations

Agritourism venue owners have a unique opportunity to bridge an ever widening gap with their consumers by providing an education through their farm. Farm visits should be experiential in nature to align with those concepts of best learning practices based on the Experiential Learning Theory. If consumers have a more positive perception and increased knowledge of the agriculture they will be more likely to make informed decision as it relates to the industry and not prey victim to organizations promoting anti-agriculture platforms.

References

- Bruch, Megan L., Amanda Ziehl, Timothy G. Prather, Russ Bragg, Ramay Winchester, Caneta Hankins, and Patricia McDaniels. *Agritourism in Focus - A Guide for Tennessee Farmers. Marketing and Value-Added Agriculture*. UT Extension, 2005. Web. 12 July 2010.
- Bruch, Megan L., and Rob Holland. *A Snapshot of Tennessee Agritourism: Results from the 2003 Enterprise Inventory*. The University of Tennessee Center for Profitable Agriculture, October 2004.
- Kolb, David A. *Experiential Learning: Experience as the Source of Learning and Development*. Englewood Cliffs, NJ: Prentice-Hall, 1984. Print.
- Merriam, Sharan B., Rosemary S. Caffarella, and Lisa Baumgartner. *Learning in Adulthood: a Comprehensive Guide*. San Francisco: Jossey-Bass, 2007. Print.

Leadership Styles of Two-Year Associate's Degree Students in Agriculture

Holly J. Kasperbauer, Graduate Student
Jill N. Casten, Graduate Student
Pavli Mykerezi, Program Director
Joe Guthrie, Agribusiness Instructor
Rick Rudd, Professor and Department Head
Virginia Polytechnic Institute and State University
College of Agriculture and Life Sciences
2270 Litton Reaves (0343)
Blacksburg, VA 24061
(540-553-5357)
hollyjo@vt.edu

Leadership Styles of Two-Year Associate's Degree Students in Agriculture

Introduction/Need for Research

Agriculture is changing at a rapid pace and to keep up with the changes, academic programs must modify curriculum to best meet the needs of students. There is a demand for continued expansion of leadership education programs on a growing demand from potential employers for students to leave college with leadership skills (Doh, 2003; Graham, 2001). To best meet the needs of businesses and organizations, colleges and universities are making their best attempt to teach the most relevant technical skills, while remembering the importance of other skills, such as problem solving, communication skills, and leadership. In agricultural education, we have identified a research priority in the area of improving student success for undergraduates enrolled in agricultural and life science academic and technical programs (Osborne, n.d.).

At [university], a unique academic program is offered for students interested in pursuing an associate's degree to directly enter careers in the agricultural and greens industries. The associate's program provides two years of curriculum, specializing in business management or landscape and turfgrass management.

With the current economic challenges, more students are pursuing degrees from community colleges before transferring into four-year programs, with an increase of almost 17% (Mullin & Phillippe, 2009). This population of undergraduate student is often underrepresented in research, especially in regards to their development of leadership skills. The lack of research led to the researchers to conduct an assessment of the two-year student's leadership styles. The purpose of the study was to assess and identify student's leadership style using the Multifactor Leadership Questionnaire (MLQ) and to determine previous leadership experiences of the students. Three research questions guided this study:

- 1) What previous experience (in either 4-H or FFA) do students have prior to entering the two-year program?
- 2) What previous leadership experience do students have (specifically serving in a position of leadership)
- 3) What are the leadership styles (transformational, transactional, or laissez-faire) of the two-year students?

Conceptual/Theoretical Framework

In recent years, the focus of studying leadership style has focused on the full range leadership approach developed by Avolio and Bass (1991). This approach suggests that leaders utilize three different styles; transactional, transformational, and laissez-faire (Bass & Avolio, 2000).

Transactional leaders emphasize the exchange between leader and follower and they achieve their desired results by using rewards and punishment, while transformational leaders develop relationships with their follows and use motivation strategies to get followers to achieve more than they originally sought to. Laissez-faire leadership refers to the non-existence of leadership (Northouse, 2010). The full range model of leadership includes nine factors, all contributing to an individual's style of leadership. In the transformational construct, five factors (idealized influence attributed, idealized influence behavior, inspirational motivation, intellectual stimulation, and individualized consideration) are described. There are three measures of transactional leadership; management-by-exception (passive), management-by-exception

(active), and contingent reward. One measure is used to identify the use of a laissez-faire style. Leaders utilize all factors of the full range model to guide decision making (Northouse, 2010).

Methodology

Two-year undergraduate students enrolled in a business course through the associates program were invited to participate in the study. Of the 61 students enrolled in the course, 46 completed the assessments for a 75% response rate. Survey research methodology was used through the use of two assessments. The first instrument was a demographic questionnaire that collected information regarding the gender, age, leadership experience, and involvement in 4-H or FFA. The second instrument was the Multifactor Leadership Questionnaire (MLQ) developed by Bass and Avolio (2000). This instrument contained 45 items measuring each of the nine factors described above. The established reliability reported by the researchers ranges from .74 to .91 in each of the constructs (Bass & Avolio, 2000).

Results/Findings

Of the group of students surveyed, 15% were female and 85% were male. Their ages ranged from 18 to 24 years, with the majority falling between 18 and 20 (80%). Of the 46 participants, 17.4% (n=8) indicated that they were involved in both 4-H and FFA in high school. An additional 17 participants (37%) reported no involvement in either organization. When asked about previous leadership experience, specifically holding a leadership position, 50% (n=23) indicated having held a position of leadership in the past.

Of the nine factors, the highest mean scores were reported for Inspirational Motivation (M=2.79, SD=.66), Idealized Influence (attributed)(M=2.70, SD=.66), Idealized Influence (behavior)(M=2.66, SD=.57), and Contingent Reward (M=2.66, SD=.58). The lowest overall means were reported for Laissez-Faire leadership (M=1.39, SD=.67). For overall leadership style, participants had the highest mean for Transformational Leadership (M=2.67, SD=.49), followed by the overall Transactional Leadership Style (M=2.19, SD=.42).

Conclusions/Implications/Recommendations

Based upon the initial research, it would appear that females are underrepresented in this associates program (with 85% being male). The research also indicated that over one-third of the participants had no involvement in either 4-H or FFA. And finally, half of the participants had previously held a leadership position. With regard to the leadership style, one can be encouraged by the findings that participants are using transformational more than transactional, but they are utilizing both styles.

Future researchers should further examine relationships that may exist between each of the constructs of the MLQ and other measures of leadership (such as emotional intelligence, critical thinking, and problem solving). Further statistical analysis should be conducted to determine if any of the variance in leadership styles can be explained by selected demographic variables.

Education in leadership should be incorporated into the curriculum for the associates degree seeking students so they can fully understand their personal leadership style and when it is most appropriate to use each of the styles.

References

- Avolio, B.J. & Bass, B.M. (1991). *The full range leadership development programs: Basic and advanced manuals*. Binghamton, NY: Bass, Avolio, & Associates.
- Bass, B.M. & Avolio, B.J. (2000). *Technical report, leader form, rater form and scoring key for the MLQ form 5x short*. Redwood City, CA: Mind-Garden.
- Doh, J. P. (2003). Can leadership be taught? Perspectives from management educators. *Academy of Management Learning and Education*, 2, 54-67.
- Graham, D. L. (2001). Employer perception of the preparation of agricultural and extension education graduates. *Journal of Southern Agricultural Education Research*, 51(1), 88-101.
- Mullin, C. M., & Phillippe, K. (2009, November). *Community college enrollment surge: An analysis of estimated fall 2009 headcount enrollments at community colleges* (Policy Brief 2009-01PBL). Washington, DC: American Association of Community Colleges.
- Northouse, P. (2010). *Leadership* (5th ed.). Thousand Oaks, CA: Sage Publications.
- Osborne, E. W. (Ed.) (n.d.). *National research agenda: Agricultural education and communication, 2007-2010*. Gainesville, FL: University of Florida, Department of Agricultural Education and Communication.

Long-term Goals: Assessing Results of Teacher Participation on Their Students

Quisto Settle
University of Florida
3127 McCarty B Hall
Gainesville, FL 32606-0540
Phone: (352) 392-1663
Fax: (352) 392-9585
qsettle@ufl.edu

Tracy Irani
University of Florida
225 Rolfs Hall
Gainesville, FL 32606-0540
Phone: (352) 392-0502 ext. 225
Fax: (352) 392-9585
irani@ufl.edu

Long-term Goals: Assessing Results of Teacher Participation on Their Students

Introduction

Shulman (1986) put forth a paradigm of teaching: successful teaching needs quality pedagogy and knowledge of the content area. The premise is that there is a need for knowledge of content, knowledge of pedagogy, and knowledge of pedagogy for specific content. The discrepancy between knowledge of pedagogy and content has been documented for science. Scales, Terry, and Torres (2009) indicated that though secondary agriculture instructors reported being able to teach science concepts, their actual knowledge did not indicate proficiency in the content area. They stated programs should focus on increasing science knowledge and methods for teaching science. Without knowledge of the content area, teachers may be less likely to incorporate it into courses, limiting opportunities for student growth in those areas. Mowen, Roberts, Wingenbach, and Harlin (2007) found that teachers who had higher self-perceived knowledge levels for specific science content were more likely to incorporate that topic into their courses. [Workshop] was set up to increase science teachers' knowledge relating to various topics, with an emphasis on emerging pathogens, to improve secondary science education. The ultimate aim of these improvements in education, though, is not with teachers; it is with students.

Methods

[Workshop] is a two-week program that brings teachers in [state] to [university]. Faculty members from the university teach lessons for participating teachers regarding new gains in science, including labs and techniques, as well as information relating to pedagogy. The teachers participated in the workshop in the summer of 2009. Four participating teachers volunteered to have their students participate in the student assessment, which was conducted in the spring of 2010. They were asked to find another teacher at their school who teaches the same or a similar class as a means of assessing results of participation in the workshop. The sample comprised 75 students of participating teachers and 64 students of non-participating teachers. The instrument assessed students' self-perceived understanding of science content, interest in science careers, interest in studying science topics, and the frequency workshop-related content is being taught.

Results

Two-way ANOVAs were used to test for main effects from [workshop] participation and schools, as well as for interaction effects on students' self-reported understanding of science, frequency with which the students' teacher includes workshop topics in class, student interest in science careers, and student interest in studying science-related topics. Kirk's (1996) descriptors are used to describe effect size. The model for this study was $Y_{ijk} = \mu + \alpha_j + \beta_k + \alpha\beta_{jk} + \varepsilon_{ijk}$, where i represents the individual, j represents [workshop] participation, and k represents the students' school. The hypotheses for this study were

$$H_0: \alpha_j = 0 \text{ for all } j$$

$$H_1: \alpha_j \neq 0 \text{ for some } j$$

$$H_0: \beta_k = 0 \text{ for all } k$$

$$H_1: \beta_k \neq 0 \text{ for some } k$$

$H_0: \alpha\beta_{jk} = 0$ for all jk

$H_1: \alpha\beta_{jk} \neq 0$ for some jk

There were no significant main effects or interaction effects on students' self-reported understanding of science. The null hypotheses were not rejected relating to student understanding of science. There was a small significant main effect from teacher participation in [workshop] on frequency with which teachers included workshop topics in class ($F(1, 42) = 6.92, p = .01, \omega^2 = .04$). Participating teachers ($M = 2.70, SD = 0.88$) were more likely to include the topics than non-participating teachers ($M = 2.51, SD = 0.81$). $H_0: \alpha_j = 0$ for all j was rejected but the other null hypotheses were not rejected relating to frequency with which teachers included workshop topics in class. There was a small significant interaction effect on students' interest in science-related careers ($F(3, 42) = 3.17, p = .045, \omega^2 = .04$). A Tukey follow-up was used, but there were no significant differences between any of the interaction groups despite the significant interaction effect. There were also no significant main effects on student interest in science-related careers from [workshop] participation or school. $H_0: \alpha\beta_{jk} = 0$ for all jk was rejected, but not the other null hypotheses relating to student interest in science-related careers. There were no significant main or interaction effects on student interest in studying science-related topics. The null hypotheses were not rejected relating to student interest in studying science-related topics.

Conclusions

Teacher participation in [workshop] only had a statistically significant effect on frequency with which teachers taught workshop-related content in classes. This is logical considering participating teachers are likely to have more exposure to the content when compared to non-participating teachers, which fits within Shulman's (1986) framework of knowledge of a content area being necessary to teach said content. There was also a statistically significant interaction effect between participation and school on students', though there were no statistically significant main effects or specific interactions. Though participating teachers are including workshop topics more in their classes, there is not evidence that the students of participating teachers have a higher understanding of science concepts than students of non-participating teachers.

Recommendations

More work should be done in the future to assess the effects of teachers participating in professional development programs. The programs cannot be considered successful if the results do not have long-term effects. More specifically, the programs cannot be considered successful if the results are not reaching students. While this study addressed student perceptions relating to results of the workshop, future work should be done to assess actual knowledge gain for students to provide a more accurate description of long-term results for participating in professional development events.

References

- Kirk, R. E. (1996). Practical significance: A concept whose time has come. *Educational and Psychological Measurement, 56*(5), 746-759. doi: 10.1177/0013164496056005002
- Mowen, D. L., Roberts, T. G., Wingenbach, G. J., & Harlin, J. F. (2007). Biotechnology: An assessment of agricultural science teachers' knowledge and attitudes. *Journal of Agricultural Education, 48*(1), 42-51. doi: 10.5032/jae.2007.01042
- Scales, J., Terry, R., Jr., & Torres, R. M. (2009). Are teachers ready to integrate science concepts into secondary agriculture programs. *Journal of Agricultural Education, 50*(2), 100-111. doi: 10.5032/jae.2009.02100
- Shulman, L. S. (1986). Those who understand: Knowledge growth in teaching. *Educational Researcher, 15*(2), 4-14. Retrieved from <http://www.aera.net/publications/?id=317>

New Competencies to be Successful as an Extension Agent in Present Context

Dona Lakai
Graduate Student
Department of Agricultural Extension Education
North Carolina State University
Raleigh, NC 27695
dlakai@ncsu.edu

K. S. U. Jayaratne, Ph. D.
Assistant Professor
214 Ricks Hall
Department of Agricultural and Extension Education
North Carolina State University
campus Box 7607, Raleigh, NC 27695
Phone: (919)515-6079
Fax: (919)515-1965
jay_jayaratne@ncsu.edu

Gary Moore, Ph. D.
Professor
Department of Agricultural and Extension Education
North Carolina State University
201 Ricks Hall
campus Box 7607, Raleigh, NC 27695
Phone: (919)515-1756
Fax: (919)515-1965
Gary_moore@ncsu.edu

Mark J. Kistler, Ph.D.
Assistant Professor
Department of Agricultural and Extension Education
North Carolina State University
Box 7607, 210-C Ricks Hall
Raleigh, NC 27695-7607
Phone: (919) 513-2349
FAX: (919) 515-1965
mark_kistler@ncsu.edu

New Competencies to be Successful as an Extension Agent in Present Context

Introduction

The Smith-Lever Act was passed by the U.S. Congress in 1914, and the Cooperative Extension Service (CES) was established (Seevers, Graham, & Conklin, 2007). It serves as an educational outreach network of the land-grant colleges and the USDA, which is “a vast network of interdependent yet relatively independent institutions throughout all the states and territories” (Boone, 1988, p. 11). It is dedicated to developing the agricultural system, and that requires continuous adaptation due to changing technology and demographics. According to Graham (1994), the CES organization is considered the “largest network of out-of-school nonformal education” in the world (p. 415). The strengths of CES are its ability to transmit research-based information and the involvement of its clients in determining, planning, and implementing programs that meet their needs. According to Petrzelka, Padgitt, and Wintersteen (1999), it is important for CES to reflect and evaluate its subject matter, audiences, and methods while moving into the 21st century. In the last two decades, CES has experienced major transformational changes in terms of programs, finances, and personnel (ECOP, 2002). The rapidly globalizing economy and increasingly complex clients have created major concerns and shifting priorities for CES. Regardless of priorities, the effectiveness of the Extension programs greatly depends on the delivery approach and competencies of the Extension agent. The identification of new competencies needed for Extension agents to be successful in changing environment is significant for planning in-service educational programs. The purpose of this poster presentation is to communicate new competencies needed for Extension agents to be successful in the Cooperative Extension.

Theoretical Framework

Maddy, Niemann, Lindquist, & Bateman (2002) defined competency in Extension education “as the basic knowledge, attitudes, skills, and behaviors that contribute to excellence in Extension education programs” (p. 1). Stone (1997) described competencies as the application of knowledge, technical skills, and personal characteristics that are designed around the abilities individuals and groups need to give effective job performances and use in making human resource decisions. Bartram, Robertson, & Callinan, (2002) defined competencies as “sets of behaviors that are instrumental in the delivery of desired results or outcomes” (p. 7). Mulder (2001) identified the roles of competency in an organization as organizational strategy, personnel management, training and development, the link between education and labor, professional development, and regional training or economic structure policies. The review of these views indicates the need for continuous identification and development of competencies for Extension professionals to be effective in generating desired outcomes with the socioeconomic and technological changes.

Methodology

This was a descriptive online survey research study conducted with a random sample of Extension agents. The survey instrument was designed and validated by a panel of experts. It was pilot tested to establish the reliability. The Cronbach alpha was .94. The survey received 66% response rate. Early and late respondents were compared to address nonresponse error (Lindner, Murphy, & Briers, 2001). Descriptive statistics were used to summarize data.

Results and Conclusions

Approximately 34.7% of the respondents identified *emotional intelligence* (EI) as the most essential competency in the current context. This would include *motivation*, *self-confidence*, and *empathy*. The individuals with emotional competency have the skill to manage their emotions in response to an events or situations, and react accordingly. In the Texas Extension Competency Model, EI competencies are parallel to the “personal effectiveness” competency (Stone & Coppernoll, 2004). The respondents perceived *interpersonal skills*, which includes *social skills*, as another important competency for extension agents. Similar to this finding, Cooper & Graham (2001) reported that personal skills including people skills, positive attitudes, friendliness, and self motivation as important competencies for agents. Other additional competencies identified by the respondents were *flexibility or adaptability* and *managing resources*. Flexibility is needed when the organizational environment is experiencing changes (Bartram et al., 2002; Cochran, 2009). Several new competencies identified by the respondents were expansion of existing core-competency for Extension Agents, especially under the *programming*, *technical/subject matters*, and *professionalism* competencies. Several respondents indicated that program evaluation and understanding how to use the Extension Reporting System (ERS) as important competencies in order to ensure accountability of Extension programming. The respondents also pointed out the need for Extension agents to have research knowledge competencies to understand the research process, interpret and apply recommendations to real life problems. *Emotional intelligence*, *interpersonal skills*, *flexibility for adapting to changing environment* and *ability manage resources* have been identified as new competencies important for Extension agents to be successful in the present context.

Recommendations

It is important to incorporate *Emotional intelligence*, *interpersonal skills*, *flexibility for adapting to changing environment* and *ability manage resources* into the current list of Extension competencies to ensure that Extension competencies are up-to-date with organizational and environmental changes.

References

- Bartram, D., Robertson, I. T., & Callinan, M. (2002). Introduction: A framework for examining organizational effectiveness. In Robertson, I. T., Callinan, M. & Bartram, D (Eds.), *Organizational effectiveness: The role of psychology, 1–10*. Chichester, West Sussex, UK: Wiley.
- Boone, E. J. (1988). *Working with our public. In-service education for Cooperative Extension; Understanding Cooperative Extension: Module 1 Our origins, our opportunities* Raleigh, NC: North Carolina State University.
- Cochran, G. R. (2009). *Ohio State University Extension competency study: Developing a competency model for a 21st Century Extension organization* (Unpublished doctoral dissertation). Ohio State University, Columbus, OH.
- Cooper, A., & Graham, D. (2001). Competencies needed to be successful county agents and county supervisors. *Journal of Extension* [On-line], 39(1). 1RIB3. Available at: <http://www.joe.org/joe/2001february/rb3.html>
- Extension Committee on Organization and Policy Personnel and Organization Committee (1992). *Implications for motivational strategies: The 21st Century Extension professional in the midst of organizational change*. Washington, DC: Author-United States Department of Agriculture.
- Graham, D. L. (1994). Cooperative Extension System. In Charles J. Arntzen (Ed.), *The Encyclopedia of Agricultural Science* (Vol. 1), 415–430. San Diego, CA: Academic Press.
- Lindner, J. R., Murphy, T. H., & Briers, G. E. (2001). Handling nonresponse in social science research. *Journal of Agricultural Education* [On-line], 42(4), 43–53. Retrieved from <http://202.198.141.77/upload/soft/0-a/42-04-43.pdf>
- Maddy, D. J., Niemann, K., Lindquist, J., & Bateman, K. (2002). *Core competencies for the Cooperative Extension System* [Report]. Retrieved from: Personnel and Organizational Development Committee (PODC) of ECOP: <http://podc.unl.edu/finalPODC.pdf>
- Mulder, M. (2001). Competence development—Some background thoughts. *The Journal of Agricultural Education and Extension*, 7(4), 147-158.
- Petzelka, P., Padgitt, S., & Wintersteen, W. (1999). Extension's portfolio for the 21st century: A place for one-on-one consultations. *Journal of Extension* [On-line], 37(6), 6COM1. Retrieved from <http://www.joe.org/joe/1999december/comm1.php>
- Seevers, B., Graham, D., Gamon, J., & Conklin, N. (2007). *Education through Cooperative Extension*. Albany, NY: Delmar Publishers.
- Stone, B. B. (1997). A system's approach to professional development. *Journal of Extension* [On-line], 35(2), 2TOT2. Retrieved from <http://www.joe.org/joe/1997april/tt2.php>
- Stone, B., & Coppennoll, S. (2004). You, Extension and success: A competency-based professional development system. *Journal of Extension* [On-line], 42(2), 2IAW1. Retrieved from <http://www.joe.org/joe/2004april/iw1.php>

PRACTICES IN MANAGING ANIMAL PROJECT CENTERS

Boot Chumbley
Texas Tech University
7306 Aberdeen #2003
Lubbock, TX 79424
(210) 383-6329
Boot.chumbley@ttu.edu

Bryan Hawkins
Sandra Day O'Connor High School
11254 Leslie Road
Helotes, TX 78254
(210) 695-4821
Bryan.hawkins@nisd.net

PRACTICES IN MANAGING ANIMAL PROJECT CENTERS

Introduction

The needs of the community, size and school budget are just a couple of factors that affect a [State] agriculture program. One large part of the agriculture program is the Supervised Agriculture Experience (SAE) project. These facilities can vary in size and scope, as they also serve as a learning lab for hands on lab experiments (Sutphin, 1984). Having an animal project center can aid an agriculture science program with the success of SAE projects, which have shown in multiple studies to be of high importance and time spent within agriculture science programs (Arrington 1984, Arrington and Cheek 1990).

Conceptual or Theoretical Framework

The use of school and community laboratories where students employ “learning by doing” is an integral part of many agricultural education programs (Sutphin, 1984). Using the animal project center helps programs provide many unique hands-on opportunities for students, which helps to develop both valuable academic and vocational skills (Hubert, Ullrich, Lindner and Murphy (2003). There has been very little research done on animal project centers and what are the best practices for running such facilities. Understanding the makeup of [State] programs is also an important tool in publicizing an FFA and agriculture science program.

Methodology

The objectives of this study were to describe animal project centers and compare what agriculture science teachers felt were top security needs. The population for this study was [State] agriculture science teachers who supervise an animal project center. An invitation to participate in the study was sent to all [State] agriculture teachers. A census of these teachers was conducted with usable responses received from 128 respondents. From the original 128 teacher responses, 108 were used as 20 of the responses were from those who did not supervise an animal project center. This research was conducted using a self-administered survey instrument with 25 questions. A pilot study was used to determine the reliability of the instrument. The survey results were taken as true and accurate.

Results/Findings

The average number of animals in the centers varied. The majority of animal project centers (52%) had between 15 -50 animal projects with 53% of facilities having less than 50 animal pens. Programs with 100- 200 animal projects made up (8%), 50-100 (30%) and less than 15 animal projects (5%). Only 4% of the programs had over 200 projects. 32% of the animal project centers had between 50 and 100 projects and pens. Average facility size correlated with the average number of animals held at the animal project center. Swine, lamb and goat projects were the most common projects housed at animal project centers. Other projects included steers, chickens, turkeys, rabbits and breeding livestock.

69% of the programs utilized a pen rent fee for students who used the project center. The average charge for these fees was between \$50 and \$75. Of the respondents 54% charged per pen with the rest of the programs (46%) charging per animal. The fees were largely used for facility maintenance and cleaning supplies. These fees were also used for bedding materials, medicine, clipping supplies and manure disposal. Bedding materials were provided by 47% of the programs with the majority (43%) utilizing sand as their primary bedding material. The agriculture teachers felt providing medication was important with 71% stating that they provided medication to students for animal projects.

The researcher found that the majority of agriculture science teachers (95%) do not provide food for livestock projects. Of those that did provide feed (5%), none of them paid for it

through project center fees. 50% of respondents allowed access to the animal project center more than 15 hours a day. Most teachers (44%) spend 1-2 hours a day supervising projects. The next largest group (31%) was teachers that spent less than an hour on animal supervision. The highest levels of concern in relation to student project centers was found to be with hours the center was open, lack of 24 hour on site security and the location of the project center.

Conclusions

The researchers found that project centers across the state, while varied, have similar patterns. The majority of [State] agriculture programs do have an animal project center. The average animal project center has between twenty-five and a hundred animals on feed with the majority utilizing less than 100 pens. The main livestock species raised by agriculture science students are swine, goats and lambs. The majority of schools charge a pen fee of \$50 to \$75. This fee is based on by either the pen or by the animal. These fees are utilized for facility maintenance, manure disposal and medical supplies. Most programs provide cleaning tools to their students to help maintain facility cleanliness. In regards to animal bedding the majority of [State] agriculture programs use sand. It was found that [State] agriculture teachers do not provide feed through their project center fees and that the majority of [State] teachers put the responsibility of buying feed on the student and parents. Those teachers, who do provide feed, don't pay for it through project center fees.

Most [State] programs provide medications for student animal projects, but do not include this expense in the projects center fees. The most important issues teachers have to deal with when running an animal project center are maintaining a clean and neat facility, security and animal health. The main security problems facing animal project centers are visitors to the center, location and hours the center is open.

Recommendations

Further recommendations for study include comparing project centers by school size, demographics and region. This information should be shared with stakeholders through professional development workshops and conferences.

References

- Arrington, L. R. (1984). *Teacher summer employment and the activity level of the FFA chapter. Journal of the American Association of Teacher Educators in Agriculture, 25(1), 48-53.*
- Arrington, L. R., & Cheek, J. G. (1990). *SAE scope and student achievement in agribusiness and natural resources education. The Journal of Agriculture Education (2), 55-61.*
- Hubert, D., Ullrich, D., Lindner, J., & Murphy, T. (2003, April 2003). An Examination of Texas Agriculture Teacher Safety Attitudes Based on a Personal Belief Scale from Common Safety and Health Practices. *Journal of Agricultural Systems, Technology and Management, 17.*
- Sutphin, H. D. (1984). *SOE: Laboratories. The Agricultural Education Magazine, 56(10), 4.*

Self-Perceived Levels of Importance of Agricultural Mechanics Laboratory Management
Competencies by Agricultural Education Pre-Service Teachers

P. Ryan Saucier
Texas State University
212 Agriculture
San Marcos, TX 78666
(512)-245-2130
ryansaucier@txstate.edu

Justin L. Killingsworth
University of Missouri
122 Gentry Hall
Columbia, MO 65211
(573)-882-7451
justinkillingsworth@mail.mizzou.edu

John D. Tummons
University of Missouri
114 Gentry Hall
Columbia, MO 65211
(573)-884-3213
tummonsj@missouri.edu

Self-Perceived Levels of Importance of Agricultural Mechanics Laboratory Management Competencies by Agricultural Education Pre-Service Teachers

Introduction/Conceptual Framework

According to Phipps and Osborne (1988) agricultural education laboratories are an essential component of the total secondary agricultural education program. Sutphin (1984) found that the use of school and community laboratories, where students employ learning by doing, is an integral part of agricultural education programs. Furthermore, Johnson, Schumacher, and Stewart (1990) stated that students learn important psychomotor skills in agricultural mechanics education and that much of the instruction takes place in the school agricultural mechanics laboratory. For current and future school-based agricultural education teachers who manage and instruct students within an agricultural mechanics laboratory, the knowledge and skills needed to manage these facilities are essential for student safety and for an optimum educational environment (Bear & Hoerner, 1986; McKim, Saucier, & Reynolds, 2010; Osborne, 2007; Saucier, Schumacher, Funkenbusch, Terry, & Johnson, 2008; Saucier, Terry, & Schumacher, 2009).

Agricultural mechanics courses are the most popular school-based agricultural education classes offered in [STATE] following the two introductory classes ([STATE] [Department of Education], 2009.) With the continuing popularity of these classes and the need for teachers to possess knowledge and skills related to the management of these courses/laboratories, research was conducted to determine the level of importance that pre-service agricultural education students placed on agricultural mechanics laboratory management competencies.

Purpose and Research Questions

The purpose of this research was to identify the importance that [UNIVERSITY] pre-service agricultural education students placed on agricultural mechanics laboratory management competencies. Subjects of the study were enrolled in the agricultural education course entitled Metal Fabrication and Laboratory Management (AGED 3310) in the fall 2008 semester. The research questions that guided this study were:

1. What are the personal and professional characteristics (i.e. sex, university semester credit hours of agricultural mechanics coursework, enrollment in school-based agricultural mechanics courses, FFA membership, completion of an agricultural mechanics related SAE project, population of hometown, and previous agricultural mechanics work experience) of [UNIVERSITY] pre-service agricultural education students who were enrolled in the agricultural education course entitled Metal Fabrication and Laboratory Management (AGED 3310) during the fall 2008 semester?
2. What level of importance do [UNIVERSITY] pre-service agricultural education students, who were enrolled in the agricultural education course entitled Metal Fabrication and Laboratory Management (AGED 3310) during the fall 2008 semester, place on agricultural mechanics laboratory management competencies?

Methodology

The population for this census were all of the [UNIVERSITY] pre-service agricultural education students who were enrolled in the agricultural education course entitled Metal Fabrication and Laboratory Management (AGED 3310) in the fall 2008 semester ($N = 19$). These students would complete their student teaching experience in the subsequent semester. Teacher educators at the [UNIVERSITY] assisted in the identification of the frame. A census was taken to more accurately describe the characteristics of the population and eliminate potential errors associated with subject selection and sampling.

For this descriptive study, researchers utilized a self-administered, paper questionnaire, presented to all pre-service agriculture education teachers that were enrolled in the undergraduate course entitled AGED 3310 Metal Fabrication and Laboratory Management. Following IRB approval, data were collected from the students on the first day of the course that resulted in a 73.38% ($n = 14$) response rate. Data were analyzed using SPSS 18.0 and Microsoft Excel® to obtain values of central tendency (mean, median, & mode) and variability (SD , f , & %). Results of the study were not generalized beyond the scope of this specific population.

Results

The majority of the respondents were female (92.90%; $n = 13$), had earned no hours in agricultural mechanics coursework (53.80%; $n = 7$) prior to this course, and were a FFA member as a youth (85.70%; $n = 12$). Over 85 percent of the respondents also indicated that they did not have an agricultural mechanics SAE project as a youth. Respondents indicated that the agricultural mechanics laboratory management competencies that they felt were the most important (top 3) included: administering first aid, documenting student safety instruction, and safely storing hazardous materials. The least important (bottom 3) competencies included: silhouetting tool/equipment cabinets, conducting an agricultural mechanics public relations program, and planning an agricultural mechanics public relations program.

Conclusions, Implications, and Recommendations

Agricultural mechanics courses remain a popular choice for school-based agricultural education students in [STATE] ([STATE] [Department of Education], 2009), however, this study suggests that student teachers have limited practical (education and work) experience to instruct agricultural mechanics courses. Respondents indicated that the agricultural mechanics laboratory management competencies that they felt were the most important were in the area of student safety. In order to broaden pre-service teacher perspective outside of initial concerns of student safety, pre-service programs should require student teachers to enroll in more agricultural mechanics coursework prior to student teaching and emphasis should be placed on providing students with laboratory safety education. In the undergraduate program of study, a prerequisite course should be designed and implemented for all students regarding safe and technically competent laboratory instruction; subsequent coursework could then focus on laboratory organization and project management. Future research should seek to describe student perceptions following the Metal Fabrication and Laboratory Management course (AGED 3310) in order to determine if focus in areas outside of safety surface as the student gained knowledge and technical experience.

References

- Bear, W. F., & Hoerner, T. A. (1986). *Planning, organizing and teaching agricultural mechanics*. St. Paul, MN: Hobar Publications.
- Johnson, D. M., Schumacher, L.G. & Stewart, B. R. (1990). An analysis of the agricultural mechanics laboratory management in-service needs of Missouri agriculture teachers. *Journal of Agricultural Education*, 35-39.
- McKim, B.R., Saucier, P.R., & Reynolds, C.L. (2010). Laboratory management in-service needs of Wyoming secondary agriculture teachers. Paper presented at the 2010 American Association for Agricultural Education Conference, USA.**
- Osborne, E.W. (Ed.) (2007). *National research agenda: Agricultural education and communication, 2007-2010*. Gainesville, FL: University of Florida, Department of Agricultural Education and Communication.
- Phipps, L. J., & Osborne, E. L. (1988). *Handbook on agricultural education in the public schools*. Danville, IL: Interstate Printers and Publishers.
- Saucier, P.R., Schumacher, L. G., Funkenbusch, K., Terry, Jr. R., & Johnson, D. M. (2008). Agricultural mechanics laboratory management competencies: A review of perceptions of Missouri agriculture teachers concerning importance and performance ability. *2008 Proceedings of the Annual International Meeting of the American Society of Agricultural and Biological Engineers, USA*.
- Saucier, P.R., Terry, Jr., R., & Schumacher, L. G. (2009). *Laboratory management in-service needs of Missouri agricultural educators*. Paper presented at the Southern Region Conference of the American Association for Agricultural Education, Atlanta, GA
- [STATE] [Department of Education]. (2009). *Course offerings and enrollments*. Retrieved from [website]
- Sutphin, H. D. (1984). SOE: Laboratories. *The Agricultural Education Magazine*, 56(10), 4.

Student Teachers' Reflection on Indicators of Engaged Learning

Mrs. Christy Witt
Dr. Scott Burris
Texas Tech University
Box 42131
Lubbock, TX 79409-2131
806-742-2816
christy.witt@ttu.edu
scott.burris@ttu.edu

Student Teachers' Reflection on Indicators of Engaged Learning

Introduction/Need for Research

“Teacher education programs seek to prepare effective and reflective teachers...On-campus microteaching with its practice of scaled-down teaching, feedback and self-analysis, offers a unique context for grounding preservice teachers in the development of effective and reflective teaching.” (Amobi & Irwin, 2009, p. 32). Student teachers are often given the opportunity to practice teaching through microteaching experiences before entering the classroom. The point of these microteaching experiences is to allow students to practice teaching in a safe environment and then reflect on the effectiveness of that experience. One element that allows teachers to judge the effectiveness of their lesson(s) is student engagement.

Consequently, secondary agricultural educators recognized active student engagement to be one of the multiple benefits of using the Kolb Model of Experiential Learning in their classrooms (Arnold, Warner, & Osborne, 2006). Experiential learning is a method commonly used in agricultural education that focuses on “learning [as] the process whereby knowledge is created through the transformation of experience” (Kolb, 1984, p. 38). In fact, “the experiential focus of secondary agricultural education has been a long standing creed for agricultural educators” (Roberts, 2006, p. 17).

The purpose of this study was to describe how the student teachers' perceptions of student engagement after each microteaching experience and examine changes in perceptions of subsequent microteaching experiences. This purpose aligns with the *National Research Agenda for Agricultural Education and Communication* (Osborne, n.d., p. 8) that has research priority areas for Agricultural Education in Schools which include the need to “prepare and provide an abundance of fully qualified and highly motivated agricultural educators at all levels.”

Theoretical Framework

This study was framed using two complimentary frameworks: experiential learning theory (Kolb, 1984) and the indicators of engaged learning (Jones, Valdez, Nowakowski, & Rasmussen, 1994). The Kolb (1984) model of experiential learning is based on a cycle of four stages, which are focused on engaging students in learning. In relation to and as a way of expanding this theory, the North Central Regional Laboratory developed eight specific indicators as part of an engaged learning and reform instruction framework. These indicators on engaged learning are: vision of learning, tasks, assessment, instructional models, learning context, grouping, teacher roles, and learner roles.

Methodology

The population for this quantitative study was student teachers enrolled in *Methods of Teaching Agriscience in the Secondary School* at [university] during the spring 2009 (N= 19) fall 2009 (N=11) semesters. As part of the AGED 4304, student teachers are asked to complete three micro-teaching experiences and then asked to do a formal reflection about each experience after each one. For this study, the researchers wanted to expand the student teachers' reflection to incorporate their perceptions about student engagement. The study utilized a 25-item questionnaire adapted from the indicators of engaged learning (Jones, Valdez, Nowakowski, &

Rasmussen, 1994) for reflection after each micro-teaching experiences. Items were measured using Likert type scales about level of agreement. Preliminary reliability estimates for these scales produced reliability coefficient scores ranging from .55-.82.

Results/Findings

To determine student teachers' perceptions of ability to incorporate indicators of engaged learning, items related to each indicator were summed and averaged to determine if mean reflection scores for each indicator changed after each subsequent reflection. As displayed in Table 1, the mean reflection scores for each indicator increased after each subsequent reflection, with the exception of Tasks & Grouping when comparing reflections 2 & 3. There is also a larger increase in mean reflection scores between the first two reflections than the last two. Upon first reflection, student teachers' perceptions of their abilities with assessment and grouping were the lowest and their abilities with their roles as a teacher was the highest. Upon their final reflection, student teachers' perceptions of their abilities in creating vision for learning was the highest and their abilities with grouping remained the lowest.

Table 1

Student Teachers' Perceptions of Ability to Incorporate Indicators of Engaged Learning (N=30)

Indicator	Reflection 1 ^a	Reflection 2	Reflection 3
Vision of Learning	3.31 ¹	3.65 ²	3.83 ²
Tasks	3.21 ¹	3.64 ²	3.64 ²
Assessment	2.89 ¹	3.54 ²	3.59 ²
Instructional Model	3.34 ¹	3.62 ²	3.72 ²
Learning Context	3.26 ¹	3.71 ²	3.77 ²
Grouping	2.89 ¹	3.23 ²	3.17 ²
Teacher Roles	3.40 ¹	3.76 ²	3.80 ²
Learner Roles	3.13 ¹	3.60 ²	3.68 ²

Note. ^a(n = 29), 1=Somewhat Agree, 2=Agree

Conclusions/Implications/Recommendations

This study found student teachers' perceptions of ability to incorporate indicators of engaged learning increased with each of three subsequent microteaching experiences and reflections. Although there was a general increase in mean reflection scores throughout the process (with the exception of Tasks & Grouping), there was a larger increase in perceived ability between the first two reflections. These increases are encouraging because it is evident that the student teachers perceive an increase in their abilities to engage students, which may be due to their reflection or increased instruction through the methods course. Based on this preliminary data, more data should be collected and analyzed to see if they support these initial findings. Future research should investigate the effects of the teaching environment (i.e. clinical environment, classroom, etc.) on student engagement. The researchers also recommend studying whether student teachers are able to control and change student engagement, especially as they become more experienced.

References

- Amobi, F. A. & Irwin, L., 2009. Implementing on-campus microteaching to elicit preservice teachers' reflection on teaching actions: Fresh perspective on an established practice. *Journal of the Scholarship of Teaching and Learning*. 9(1), 27-34.
- Arnold S., Warner, W. J., & Osborne E. W., 2006. Experiential learning in secondary agricultural education classrooms. *Journal of Southern Agricultural Education Research*. 56(1), 30-39.
- Jones, B. F., Valdez, G., Nowakowski, J., & Rasmussen, C., 1994. Designing learning and technology for educational reform. Oak Brook, IL: North Central Regional Educational Laboratory.
- Kolb, D.A. (1984). *Experiential learning*. Englewood Cliffs, NJ: Prentice-Hall, Inc.
- Means, B. (Ed.), 1994. Technology and educational reform: The reality behind the promise. San Francisco: Jossey Bass.
- Osborne, E. W. (Ed.) (n.d.). *National research agenda: Agricultural education and communication, 2007-2010*. Gainesville, FL: University of Florida, Department of Agricultural Education and Communication.
- Roberts, T. G. (2006). A philosophical examination of experiential learning theory for agricultural educators. *Journal of Agricultural Education*. 47(1), 17-29.

Teaching Beliefs of Excellent Undergraduate Professors

Aaron Giorgi, Graduate Assistant
T. Grady Roberts, Associate Professor
P.O. Box 110540
Gainesville, FL 32611-0540
(352) 392-0502 ext. 244

Teaching Beliefs of Excellent Undergraduate Professors

Introduction

The main goal for a teacher, in any capacity, is student learning. The formal teaching/learning process typically involves interactions between the teacher, learners, content, and the learning environment (Dunkin & Biddle, 1974). One piece of this complex process is the beliefs of the teacher about the learning process. A successful teacher has a clearly defined teaching philosophy outlining their core values as an instructor. Understanding the teaching beliefs of excellent teachers can allow novice teachers to develop into excellent teachers by modeling the beliefs and behaviors exhibited by their accomplished peers.

Theoretical Framework

The Theory of Planned Behavior (Ajzen, 1991) proposes that a person's beliefs influence their intentions, which in turn influence their behaviors. Teacher classroom behavior ultimately affects students' achievement (Fang, 1996). Teaching involves two domains: (a) teachers' thought processes, and (b) teachers' actions and their observable effects. Understand teacher's thoughts and actions will give us a better understanding of how these two components interact to increase or inhibit student performance (Clark & Peterson, 1986).

According to Heimlich (1990) sensitivity and inclusion are the two key dimensions that describe the teacher's beliefs related to their thoughts and actions. Sensitivity relates to the understanding of the group (learners) needs, while inclusion refers to the amount of control the students are allowed over their learning within the instructor's classroom. Combining the two dimensions allows for teachers to be categorized into four groups: (a) *Experts* have low sensitivity and low inclusion; (b) *Facilitators* have low sensitivity and high inclusion; (c) *Providers* have high sensitivity and low inclusion; and (d) *Enablers* have high in sensitivity and high in inclusion.

A potential means for improving the learning environment and facilitation of learning for the benefit of the learners, is for educators to understand their predilections toward a teaching style (Heimlich, 1990). By delineating the beliefs a model can be established. According to the components of the social learning theory presented by Bandura (1977) most behaviors are learned through modeling. The effectiveness of the model is directly correlated to the functional value of the behaviors and the status of those modeling within the social group. Models are more likely to be adopted when the outcome, student achievement in this case, has value within the system. It is also stipulated that the level of association within a social setting delimits the modeling opportunities (Bandura, 1977).

Methods

The purpose of this study was to explore teaching beliefs of excellent teachers. To accomplish this purpose, this study used a case study of faculty in the Academy of Teaching Excellence in the [college], at the [university]. This group includes professors who were elected to membership based on receiving awards and recognition for teaching. The target population was all members currently employed at [University], totaling thirty three professors since 2008 ($N = 33$). Twenty-two members of the academy ($n = 22$) elected to participate and thus constituted the

case. Each professor completed a researcher modified Van Tilburg/Heimlich Teacher Belief Scale (Heimlich, 1990) administered through an online questionnaire. Data were collected using the Tailored Design Method (Dillman, 2000).

Results

Respondents were scored on two axes, sensitivity and inclusion. Based on the plotted scores (see Figure 1), respondents fell into one of four categories: expert, facilitator, enabler, and provider. It was found that of the sample 77% (n=17) were scored as “enabler,” 14% (n=3) were scored as “provider,” 4% (n=1) were scored as “facilitator,” and 4% (n=1) scored as an “expert.” The mean calculated score for sensitivity was 8.5, and for inclusion the score was 6.5. Both scores are calculated on a range from 0 to 11.

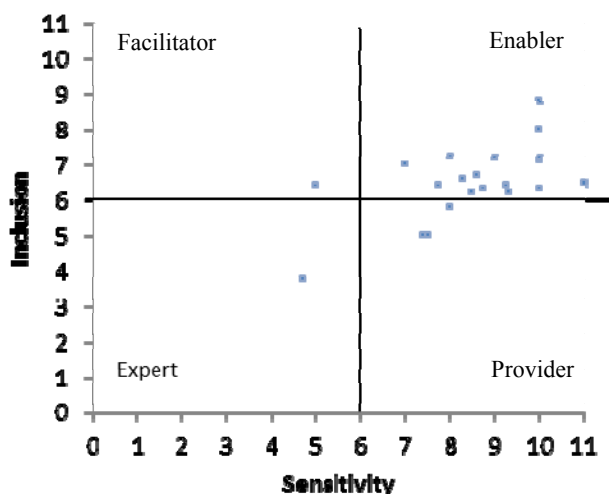

Figure 1. Teaching beliefs of excellent teachers.

Conclusions, Recommendations, and Implications

The majority of faculty in the Academy of Teaching Excellence in the [college] at [university] are classified as enablers (Heimlich, 1990). This means that this group is high in sensitivity and high in inclusion. These findings mirror the data collected by Heimlich; he found that 69% of his respondents also scored within the enabler category. Since members of the academy were selected through a student nomination and peer evaluation process, this implies that students and faculty in the [college] at [university] value teachers that are sensitive to student needs and inclusive of all students. New instructors should strive to model these behaviors.

The results of this study only apply to this small group. Teaching beliefs of faculty not in the academy should be examined to see if similarities exist. Additionally, this study should be replicated at other universities and in other disciplines to see if similar results are found. Finally, teacher beliefs and behaviors are inputs in the learning process. Teaching beliefs should be compared with student performance (learning) to determine if relationships exist.

References

- Ajzen, I. (1991). The theory of planned behavior. *Organizational Behavior and Human Decision Processes*, 50, 179-211
- Bandura, A. (1977). *Social learning theory*. Upper Saddle River, NJ: Prentice Hall
- Clark, C. M., & Peterson, P. L. (1986). 'Teachers' thought processes.' In: Wittrock, M. C. (Ed) *Handbook of Research on Teaching*. New York, NY: Macmillian, pp. 255-296.
- Dillman, D. A. (2000). *Mail and internet surveys: A tailored design method* (2nd ed.). New York, NY: Wiley.
- Dunkin, M. J., & Biddle, B. J. (1974). *The study of teaching*. Washington, DC: University Press of America, Inc.
- Fang, Z. (1996). A review of research on teacher beliefs and practices. *Educational Research*, 38(1), 47-65.
- Heimlich, J. E. (1990). *Measuring teaching style: A correlation between the Van Tilburg/Heimlich sensitivity measure and the Myers/Briggs personality indicator on adult educators in Central Ohio*. (Doctoral dissertation) Retrieved from <http://etd.ohiolink.edu/>

Teaching Locally, Engaging Globally: Examining Faculty Pre-Trip Attitudes and Beliefs

Jessica Kochert, Amy Harder, T. Grady Roberts, Nicole Stedman, Marta Hartmann

University of Florida | PO Box 110540 | Gainesville, FL 32611-0540

Phone: 352-392-0502 ext. 238

jlgoald@ufl.edu

Introduction/Need for Research

Institutions of higher education have continued to embrace the importance of producing graduates who are culturally literate and who demonstrate high capacity for solving problems within a global context (Brooks, Frick, & Bruening, 2006). Globalization is often addressed through strategies such as globally-focused courses, study abroad opportunities, and travel courses, and while U.S. student participation in study abroad opportunities has more than tripled over the past two decades (Institute of International Education, 2009), these opportunities are accessed by a limited number of students (Dolby, 2005). In order to provide students in agricultural and life science programs additional access to culturally-rich, yet contextually-relevant content, the multi-institutional Teaching Locally, Engaging Globally (TLEG) project was developed to teach faculty how to create reusable learning objects (RLOs) and authentic case studies that address multidisciplinary issues from a global viewpoint.

Conceptual or Theoretical Framework

The design of the TLEG project is rooted in Kolb's (1984) experiential learning cycle. The first phase of the project was designed to provide faculty experience and expertise necessary to create global content related to the USDA priority areas. According to Kolb, learning is a "continuous process grounded in experience" (Kolb, 1984, p. 28). Effective learning allows individuals to "involve themselves fully, openly, and without bias in new experiences...reflect on and observe their experiences from many perspectives...create concepts that integrate their observations into logically sound theories, and...use these theories to make decisions and solve problems" (Kolb, 1984, p. 30). Therefore, Phase 1 of the TLEG project provided faculty with the opportunity to explore their discipline in the context of a global setting using the experiential learning process.

The experience stage of Kolb's cycle asks learners to enter into the experience "fully, openly, and without bias" (Kolb, 1984, p. 30). In order to attempt to provide awareness of potential biases that may exist prior to the cultural opportunity, faculty members were asked to participate in a prereflection activity. According to Jones and Bjelland (2004), prereflection is "the process of being consciously aware of the expectations associated with a learning experience" (p. 963). The prereflection stage provides a new starting point to Kolb's experiential cycle that begins not with the experience itself, but from a conscious assessment of pre-existing thoughts, attitudes, or biases which may impact the learning process.

Methodology

The purpose of this study was to identify through a prereflection activity the initial attitudes and beliefs that participants held prior to their visit to Latin America. Participants in the study were members of the university cohort that traveled to Ecuador in August 2010. Participants were asked to complete a questionnaire containing four open-ended questions, approximately three weeks prior to their trip departure. Of interest to this study were the responses to the question that asked participants to identify their initial attitudes/beliefs about visiting Latin America. Responses from the eight participants were analyzed using Lincoln and Guba's (1985) adaptation of Glaser and Strauss' (1967) constant comparative method. Two of the researchers independently reviewed the data, identifying pertinent comments and persistent themes, and then worked together to identify those themes and supporting comments that were consistent.

Following this process, a member check (Lincoln & Guba, 1985) was conducted in order to confirm the accuracy of their quotes and appropriateness of the theme it was placed within. No changes were necessary.

Results/Findings

Three main themes emerged from the analyses: *social expectations*, the *physical environment*, and *influences on pre-trip attitudes*. It was common within all three themes for the participants to frame their responses with comparisons of Latin America and the U.S. The theme of *social expectations* included participant responses, which identified various cultural expectations focused on general cultural ideas of religion, family, and overall diversity, as well as specific beliefs about the interpersonal characteristics and other generally-held beliefs about Latin American people. Participants also identified a variety of Third World perceptions, such as the participant who said “Most Latin American countries would be considered Third World because of poverty.”

The *physical environment* theme included participant responses that identified a variety of beliefs about the natural environment. A response typical of this theme was “Latin America showcases the relationship between physical biodiversity and plant biodiversity.” Participant responses ranged from the rich biodiversity of the region to the management of natural resources.

The *influences on pre-trip attitudes* theme diverged into the potential learning opportunities for faculty and various travel concerns. Faculty were excited to “experience a new culture and learn about issues... in Latin America” but some were concerned that “most of what we eat will be unfamiliar” and that while “trying a lot of different foods...I may get sick.” Responses within the potential learning opportunities included only positive perceptions, while travel concerns seemed to be mainly negative in nature.

Conclusions

Participants seemed to have generally positive or neutral pre-existing beliefs and attitudes about Latin America. However, these were tempered with a number of concerns regarding travel, transportation, and the perceived intrusiveness of the visit itself. The tendency for participants to discuss the U.S. during their responses about Latin American suggests many of the attitudes and beliefs were influenced by either conscious or subconscious comparisons of the U.S. to the destination country.

Implications/Recommendations/Impact on Profession

Preflection provides the opportunity for participants to better position themselves to enter into a new experience “fully, openly, and without bias” (Kolb, 1984, p. 30). The findings from this study indicate preflection is a needed step when planning travel abroad experiences for faculty, because they do hold both positive and negative biases that may influence their experience. Universities planning faculty study abroad trips may find the inclusion of the preflection process to be a valuable addition to the experiential learning process. Through preflection, faculty members will be better positioned to create resources for university classrooms that are culturally-rich, contextually-relevant, and not as limited by preconceptions that may exist.

References

- Brooks, S. E., Frick, M., & Bruening, T. H. (2006). How are land-grant institutions internationalizing undergraduate agricultural studies? *Journal of International Agricultural and Extension Education*, 13(3), 91-102.
- Dolby, N. (2005). Globalisation, identity, and nation: Australian and American undergraduates abroad. *The Australian Educational Researcher*, 32(1), 101-118.
- Glaser, B. G., & Strauss, A. L. (1967). *The discovery of grounded theory: Strategies for qualitative research*. Chicago: Aldine Pub. Co.
- Institute of International Education. (2009). *Open doors 2009: Fast facts*. Retrieved from Institute of International Education website: <http://www.iie.org/en/Research-and-Publications/Open-Doors>
- Jones, L. & Bjelland, D. (2004). International experiential learning in agriculture. *Proceedings of the 20th Annual Conference of the Association for International Agricultural and Extension Education, Dublin, Ireland*, 963-964. Retrieved from <http://aiaee.tamu.edu/2004/Carousels/jones-carousel-NEW.pdf>
- Kolb, D. A. (1984). *Experiential learning: Experience as the source of learning and development*. Englewood Cliffs, N.J: Prentice-Hall.
- Lincoln, Y. S., & Guba, E. G. (1985). *Naturalistic inquiry*. Beverly Hills, CA: Sage Publications.

Terminal Publication of AAAE Conference Papers

Nathan Conner, Graduate Assistant
Christopher T. Stripling, Graduate Assistant
T. Grady Roberts, Associate Professor

University of Florida
PO Box 110540
Gainesville, FL 32611-0540
352- 392-0502 ext. 238
nathan.conner@uf.edu
cstripling@ufl.edu
groberts@ufl.edu

Terminal Publication of AAAE Conference Papers

Introduction/Need for Research

In recent years there has been considerable discussion within the American Association for Agricultural Education (AAAE) about publishing full conference papers and journal articles (Edward W. Osborne, personal communication, October 25, 2010). Within AAAE, it has been widely accepted that the same piece of research may appear in conference proceedings and then in a journal. Historically, conference proceedings were distributed at the annual conference, either as paper copies or on compact disks. However, in recent years the proceedings have been posted on the AAAE website, thus making the full conference papers available to anyone. This accessibility raises the issue of publishing the same piece of research in two places. At the heart of the matter is the potential for accusations of dual publications, which would typically be considered unethical. With that being said, the extent that the same research appears in the AAAE research proceedings and then in a journal is unknown. This study explores this issue.

Conceptual or Theoretical Framework

The scientific world has been going through a change in publishing methods. “By the turn of the century, 75 percent of academic journals were offering online editions, and more than 1,000 peer-reviewed journals existed only in digital form” (Willinsky, 2003, p.263). According to Willinsky, this change has allowed publications to extend their circulation due to the decreased cost of publishing online. The changes have also led to considerable debate regarding open access publishing on the internet. Proponents of open access publishing stress that the increased circulation will enhance the fields knowledge base, whereas opponents are concerned with copyright laws and how open access journals will affect them professionally (Björk, 2004).

Methodology

The purpose of this study was to explore the extent that AAAE conference papers are also published in a journal. The study was conducted through an analysis of conference papers and journal articles. Full text conference proceedings were obtained from the AAAE website and full text journal articles were obtained from the *Journal of Agricultural Education (JAE)* website. This study analyzed conference proceedings from 2005 to 2009 because they are the five most recent years of proceedings that have been posted on the internet. Each year of the proceedings were cross referenced with subsequent years of the *JAE*. For example, the proceedings from 2005 were cross referenced with the *JAE* 2006(47), 2007(48), 2008(49), 2009(50), and 2010(51). This method of cross referencing was replicated for the 2006 through the 2009 conference proceedings. Authors of conference papers that were not published in the *JAE* were contacted through email to determine if their paper was published in any other peer-reviewed journal.

Results/Findings

Between 2005 and 2009, 252 papers appear in the AAAE conference proceedings. One hundred eleven (44.05%) out of the 252 of the papers were published in a peer-reviewed journal. At the

time of submission there were 42(16.67%) proceeding articles that authors had not responded to. Table 1 below shows the publication status of AAAE Conference papers.

Table 1
Terminal Publication of AAAE Conference Papers

Publication Status	Frequency	Percentage of Published Papers	Overall Percentage of Papers
Total Published Elsewhere	111	100.00	44.05
<i>Book</i>	1	0.90	0.40
<i>Journal of Agricultural Education</i>	85	76.58	33.73
<i>NACTA Journal</i>	7	6.31	2.78
<i>Academic Exchange Quarterly</i>	1	0.90	0.40
<i>Career and Technical Education Research</i>	3	2.70	1.19
<i>Journal of Career and Technical Education</i>	2	1.80	0.79
<i>Journal of Southern Agricultural Education</i>	5	4.50	1.98
<i>Journal of Leadership Education</i>	2	1.80	0.79
<i>Journal of Applied Communications</i>	2	1.80	0.79
<i>Journal of Extension</i>	3	2.70	1.19
Total Unpublished	99		39.28
Undetermined ¹	42		16.67

¹Authors are still being contacted to determine status of these papers.

Conclusions

An analysis of conference papers and journal articles revealed that 44.05% of the AAAE conference papers from 2005-2010 were also published in a peer-reviewed journal or book. AAAE conference paper authors used the *JAE* as their primary avenue for publishing their conference papers in a peer-reviewed journal, with one-third being published in that journal.

Implications/Recommendations/Impact on Profession

This study sought only to explore the publication practices of AAAE members related to conference papers and journal articles. The following discussion is offered to provide some things to think about. There has been discussion about “rogue” literature versus “permanent” literature. The prevalence of the Internet and online publishing has moved this dichotomy from a black and white issue to a very gray issue, with both sets of research being readily available (www.jae-online.org and www.aaaeonline.org). With just under half of AAAE papers being published in a journal, there exists considerable potential for accusations of unethical behavior. Although AAAE has embraced this practice, AAAE members risk exposing themselves to accusations of double publishing during the promotion and tenure process. This research has just begun to explore this complex issue. This comparison just looked for similarities in paper and article titles. Further research should compare titles and authors in matched research. Additionally, the actual content of the articles should be compared to determine the similarity of AAAE papers and matched journal articles. Future researchers are urged to undertake this process in a way that informs the profession, not that singles out individual scholars.

References

- Björk, B. C. (2004). Open access to scientific publications- an analysis of the barriers to change? *Information Research*, 9(2). Retrieved from <http://informationr.net/ir/9-2/paper170.html>
- Willinsky J. (2003). The nine flavours of open access scholarly publishing. *Journal of Postgraduate Medicine*, 49(3), 263-267. Retrieved from <http://www.jpgmonline.com/text.asp?2003/49/3/263/1146>

4-H and Facebook: Can they Co-Exist?

Jessica Anderson
Graduate Assistant
North Carolina State University
Agriculture and Extension Education
Campus Box 7607
Raleigh, NC 27695
724-984-5191
jaander3@ncsu.edu

K.S.U. Jayaratne
Assistant Professor
North Carolina State University
Agriculture and Extension Education
Box 7607
Raleigh, NC 27695
jay_jayaratne@ncsu.edu

4-H and Facebook: Can they Co-Exist?

Introduction

Millennial youth know how to network with their peers better than any generation of the past. Whether it is staying in touch with the latest gossip or sharing their current 4-H project, these youth are accustomed to using new technology to stay constantly connected through social networks (Rhoades, Thomas, & Davis, 2009). Teenagers have ranked social media sites, such as Facebook and Twitter, as a preferred method of communication, along with cell phones and Instant Messenger (Lenhart, Madden, Macgill, & Smith, 2007), making them a great way to reach this audience with information. Companies and organizations have incorporated many of these new social technologies into their communication plans as a way to reach a more youthful audience.

Facebook is a social networking site where users interact through a constantly evolving myriad of information including friendships, interest groups, fan pages, and other criteria (Educause Learning Initiative, 2007). Over the years, the site has evolved, giving users more options on creating their profiles and how they interact with others. Facebook provides users with an interactive Web page-like format to share information, photos, articles, and Web links. This venue makes it easy to post a message that can be shared with small or large communities of users (Kinsey, 2010). Facebook attracts followers who are organizations or individuals interested in the creator's postings. Extension educators may find it useful to communicate information regarding upcoming events, informational pieces, and publications (Kinsey, 2010). Added to this flexibility is what some believe one of the industry's strongest, most detailed privacy policies, as a precedent, putting control into the user's hands to determine who can see their information and what they can do with it (Educause Learning Initiative, 2007).

With the development of new social technology, agents and youth are developing site personas, groups, and networks on popular sites like Facebook; therefore it is important to understand how youth are using this technology (Rhoades, Thomas, & Davis, 2009). While some 4-H camps have instituted guidelines for proper usage of these sites by their staff (Bovitz, 2007) and some educators have begun working with youth on protecting themselves online, usage of these sites is still new and evolving.

How it Works

With increasing technology comes increasing responsibility especially when it comes to youth programs, such as 4-H. Extension must be communicating on social networks where many youth are, but educators must also be monitoring such sites for how the pages represent 4-H and Extension (Rhoades, Thomas & Davis, 2009). Therefore, it is imperative for Extension to provide guidelines especially dealing with privacy issues among 4-H groups. The purpose of this poster is to display a guideline for dealing with privacy issues. This includes managing the following tasks:

Maintaining the Site

- Extension Professionals, 4-H Adult Volunteers, and 4-H Members with proper supervision should only be the ones with access to making changes to the site (Rhoades, Thomas & Davis, 2009).

Privacy

- Privacy settings should be set to “friends only” option. That means that only friends who are accepted by the administration of the Facebook page will have access to the information provided.
- Alternately, limited information can be provided to those who are not friends, such as contact information.

Contact Information

- Contact information should be given out for the Extension office, Extension professionals, and/or 4-H Adult Volunteers only. No contact information should ever be given out for 4-H members.

Photos and Videos

- Photos and videos should be set to “private” settings where only friends of the page can see. Just as photo consent is needed for publication, Facebook is a publication and the same consent is needed.
- Tagging photos of 4-H members should be done carefully and thoughtfully. A tag could take someone to that members personal profile page which could potentially have material not appropriate for 4-H.
- These pages are a great way for youth and educators to share photos and experiences. They also offer a way to possibly recruit more youth who are in members' networks (Rhoades, Thomas, & Davis, 2009).

These guidelines are set up in an example Facebook page that Extension professionals and volunteers “friend” to model their own pages after. By using the many applications on these sites to share the positive experiences through Extension and 4-H, friends of current page members will be exposed to and possibly intrigued by the organization (Rhoades, Thomas, & Davis, 2009).

Future Plans/Advice to Others

These guidelines should be taken into consideration for all 4-H groups who maintain a Facebook page for 4-H purposes. More research should be conducted to analyze the existing 4-H Facebook pages for how 4-H is represented online.

Cost/Resources Needed

Costs associated with this program are minimal. Resources needed are all available online and free to extension agents and 4-H volunteers and members.

References

Bovitz, L. (2007). In their own words—Understanding the communication styles of teens. *Journal of Extension* [On-line], 45(2) Article 2T0T1. Available at: <http://www.joe.org/joe/2007april/tt1.php>

Educause Learning Initiative. (2007). *7 things you should know about Facebook II*. Retrieved November 4, 2010, from: <http://www.educause.edu/ELI/7ThingsYouShouldKnowAboutFaceb/156828>.

Kinsey, J. (2010). Simple steps to making a Web-based video. *Journal of Extension* [Online], 48(4) Article 4TOT2. Available at: <http://www.joe.org/joe/2010august/tt2.php>

Lenhart, A., Madden, M., Macgill, A. R., & Smith, A. (2007, December 19). *Teens and social media*. Retrieved June 5, 2008 from: <http://www.pewinternet.org>

Rhoades, E., Thomas, J.R., & Davis, A. (2009). Social networking among youth: How is 4-H represented? Retrieved September 15, 2010 from: <http://www.joe.org/joe/2009october/a6.php>

Title: A Little Birdie Told Me: Using Twitter as a Discussion Tool

Lauri M. Baker
PO Box 110540
Gainesville, Florida 32611-0540
352-392-1663
Lauri.m.baker@ufl.edu

Christy Chiarelli
PO Box 110540
Gainesville, Florida 32611-0540
352-273-0793
ccw@ufl.edu

Quisto Settle
PO Box 110540
Gainesville, Florida 32611-0540
352-392-1663
qsettle@ufl.edu

A Little Birdie Told Me: Using Twitter as a Discussion Tool

Introduction/Need for Innovation or Idea

As technology becomes more prevalent in society, technology and teaching have developed a natural kinship. Mishra and Koehler (2006) put forth a framework for teaching with technology that involved content, pedagogy, and technology; instead of viewing these components as separate entities, they are treated as related concepts where all three are necessary for a teacher to be successful. Because social media are pervading students' lives, many teachers are implementing social media into classes (Robin, 2008). If social media are to become a successful technological component of education, there is a need to understand the successes and nonsuccesses of individual applications of social media in education. This study examined the effectiveness of one social media tool, Twitter, as a classroom discussion tool.

Twitter is a microblog that allows its 175 million registered users to post messages up to 140 characters (2010). Twitter's original purpose was for users to answer the question "what are you doing?" in 140 characters or less. This type of communication is referred to as two-way asymmetrical communication in which Twitter was attempting to gain information from users without altering the functioning of their communication medium. However, social media, which Twitter is a part of, is a user-driven medium that allows its users to not only create content but also affect the site as a whole. For Twitter, the creation of hash tags (#) and replies to other users (@) were user-created phenomena. Additionally, users began to engage one another in extended conversations, which were an unintended consequence of Twitter (Honeycutt & Herring, 2009). This inherent interactivity alters the medium from two-way asymmetrical communication to two-way symmetrical communication where all users have equal standing and "dialogue [is used] to manage conflict, improve understanding, and build relationships" (Grunig & White, 1992, p. 39). Due to user engagement, Honeycutt and Herring (2009) state that one important person-to-person interaction via Twitter could be collaboration. Furthermore, due to its access flexibility, Twitter has the opportunity to become a tool for users to share ideas and coordinate activities (Honeycutt & Herring, 2009).

Methodology

Twitter was used in a college of agriculture honors course about climate change with 13 students. None of the students had previous experience with Twitter so based on Grosbeck and Holotescu's (2008) recommendations for using Twitter as an educational tool, the instructor explained to students the premise of Twitter and how it functions. Additionally, the instructor worked to be flexible and open to the direction in which the tweets led and included the students in the evaluation of the tool, which was also recommended by Grosbeck and Holotescu. A hashtag (#) was used to track all student tweets. Students were required to tweet about the course twice a week but were encouraged to tweet more and respond to class members with direct replies. Additionally, the teaching assistant responded to students' tweets and proposed other questions to the group. The students got responses from people who were not in the class, which added a component not seen in other types of class discussion tools. A descriptive survey methodology was utilized to determine student perceptions of using Twitter as a discussion tool. All 13 students in the course completed the survey, resulting in a 100% response rate. To conduct the evaluation, a 25-item questionnaire was developed that asked questions about the use of Twitter in the course and its effect on student learning.

Results to Date

The students indicated the use of Twitter in this class did not enhance their overall learning, with a mean of 1.9 in response to the statement "the use of Twitter in this class

enhanced my overall learning.” This was on a five-point scale with one being “strongly disagree” and five being “strongly agree.” Additionally, the students reported that using Twitter for the discussion component of the course was not a good use of their time, with a mean of 4.09, in response to the statement “the Twitter portion of this class was a waste of my time.” Additionally, when given the statement “using Twitter caused me to think deeper about the class,” the mean score was 2.18. However, in response to the statement “I see value in using technology to submit course assignments,” students were receptive, with a mean score of 4.18. The students were neither happy nor unhappy to have gained new media skills through the use of Twitter, with a mean of 3.18 in response to the statement “I am happy to have learned new media skills from this class.” The participants’ comfort with using new media in their personal lives was above average on the presented continuum, with a mean of 3.9 in response to the statement “I am comfortable using new media for my personal use.” Students were more comfortable using new media for educational purposes, with a mean of 4.18 in response to the statement “I am comfortable using new media for educational purposes.” Fifty percent of the students said they would have preferred the discussion component of the course be done through the university’s course management system. Twenty-five percent reported they would have preferred the discussions be done through Facebook, while only 0.2% said they preferred discussions being done through Twitter. A few students had suggestions for other discussion tools they would have preferred to use, specifically BlogSpot or Google Wave.

Future Plans/Advice to Others

While this study followed previous recommendations from Grosbeck and Holotescu (2008) on how to implement Twitter as an educational tool, the students in this course were not receptive to its use. There are multiple reasons why implementation may not have been successful in this case, which could give guidance to other instructors thinking about using Twitter in their courses. This course comprised majors throughout the college of agriculture, none of which were in majors related to communication or technology. Additionally, this group reported they were not comfortable using new media in their personal lives. As such, the authors recommend a longer introduction to the technology in groups that are less familiar with the tool. Moreover, this study indicates a need for special attention to be paid throughout the process of Mishra and Koehler’s (2006) framework for teaching with technology, which involves the interaction of content, pedagogy, and technology. Future classroom use of Twitter should include more content related to the use of Twitter and integrate new developments related to Twitter with regard to content and real world use. The use of Twitter may be more effective in a less formal environment, like in an extracurricular organization using experimental learning practices.

Cost/Resources Needed

Twitter is a free service. Students can set up personal accounts at no charge. Students will need access to a computer or other device connected to the Internet to access their Twitter account.

References

- Grosseck, G., & Holotescu, C. (2008). *Can we use Twitter for educational activities?* Paper presented at the 4th International Scientific Conference eLSE. Bucharest, Romania, April 17-18, 2008. Retrieved from <http://www.morsmal.org/documents/members/admin/Can-we-use-Twitter-for-educational-activities.pdf>
- Grunig J. E., & White, J. (1992). The effect of worldviews on public relations theory and practice. In Grunig, J. E. (Ed.), *Excellence in public relations and communication management* (pp. 31-64). Hillsdale, N.J.: L. Erlbaum Associates.
- Honeycutt, C., & Herring, S. C. (2009). Beyond microblogging: Conversation and collaboration via twitter. *Proceedings of the 42nd Hawaii International Conference on System Sciences*. Retrieved from <http://ieeexplore.ieee.org/stamp/stamp.jsp?tp=&arnumber=4755499>
- Mishra, P., & Koehler, M. J. (2006). Technological pedagogical content knowledge: A framework for teacher knowledge. *Teachers College Record*, 108(6), 1017-1054. Retrieved from <http://www.tcrecord.org/>
- Twitter. (2009). *About*. Retrieved from <http://twitter.com/about>

**A Mobile Classroom for Visual Communications on the Road in [State]:
Using High School Students to Create Video and Photo Projects to Promote Agriculture**

Kristin M. Pennington
Graduate Assistant
University of Arkansas
205 Agriculture Building
Fayetteville, AR 72701
(479)575-4352/ (479)575-2610 Fax
khopper@uark.edu

Leslie D. Edgar
Assistant Professor
Agricultural Communications
University of Arkansas
205 Agriculture Building
Fayetteville, AR 72701
(479)575-4352/ (479)575-2610 Fax
ledgar@uark.edu

Don W. Edgar
Assistant Professor
University of Arkansas

Casandra Cox
Instructor
University of Arkansas

Allyson McGuire
Graduate Assistant
University of Arkansas

Beth Ann Hunt
Graduate Assistant
University of Arkansas

A Mobile Classroom for Visual Communications on the Road in [State]: Using High School Students to Create Video and Photo Projects to Promote Agriculture

Introduction/Need

In 2006, the National Research Agenda [NRA]: Agricultural Education and Communication 2007-2010 (Osborne, n.d.) was developed and outlined critical components of agricultural education and communications. Agricultural education and communications faculty have forged alliances and work closely to develop courses and research projects to understand and promote various aspects of the industry. With the growing availability of technology and as the general public becomes further removed from the farm, communication becomes ever critical to the promotion of agriculture (Bailey-Evans, 1994). Postsecondary and secondary education today is a dynamic educational environment as new, electronic technologies and their academic potential emerge. These technologies allow each institution to explore innovative ways to reach new and/or larger audiences, collaborate with peer institutions, and reduce instructional duplication and costs. Additionally, agriculture as a field of study continues to diversify and change, aiming to meet the needs of producer and commodity groups. This change and diversification brings the need to more effectively communicate and promote agriculture to an audience who is uneducated about agriculture and its practices.

New communication media have changed the thoughts and ideas of people pertaining to agricultural fields. The World Wide Web, videography, digital photography as well as other media are used in the most basic agricultural professions or tasks. Visual technologies assist agriculture by increasing the effectiveness and audience reach of specific topics and processes to its publics. Images used to communicate in the agriculture industry are essential to developing an understanding and can be read, construed, and used in different ways and multi-functions, like words (Weber, 2006). Visual communication technologies are used to show a story or topic rather than to tell about it. Often images have more lasting impact than words alone (Lester, 1995). When combined with text, images dominate words and are processed in the brain to create perceptions about the subject (Barry, 1997). Visual communication technologies assist with telling stories in multiple formats (via text and images).

Through this project asynchronous, agricultural communications curriculum was created specifically in writing, photography and videography (visual communications and technology), and careers in agricultural communications. Based on preliminary research, [state] agricultural science teachers lack knowledge and competencies in agricultural communications. Data further demonstrated that teachers perceived technology abilities by their students as intermediate to proficient; while teachers believed their abilities were intermediate but not proficient. This finding is alarming in today's technological advanced era whereby students and teachers may not be meeting medium proficiency standards (US DOE, 1996). Because many digital natives (youth growing up in the digital era) are interested in technology and high schools in [state] teach little to no content in agricultural communications, there was a need to develop curriculum and activities in visual communications that could be used to more effectively promote agriculture.

How it Works/Methodology

The target objectives of this project included developing electronic agricultural communications curriculum, create a mobile classroom to educate teachers and students about visual communication technologies, and assisting high schools throughout [state] in developing and creating *YouTube* videos to promote and market agriculture. The associated curriculum and

demonstrations affect students' knowledge in multiple disciplines found in food, agricultural sciences, and communications and journalism. Visual communication curriculum was developed for secondary agricultural science students and focused on: (1) Writing - effective writing, grammar and punctuation, writing for an audience, writing in agriculture, identifying a good agricultural story, interviewing, and storyboarding; (2) Photography - selecting a camera, proper camera use, photo composition, and shooting livestock, row crops, and machinery in motion; (3) Videography - selecting a camera, proper camera use, videoing techniques, managing raw video, editing, digital titles, adding music, and publishing in public domain (specifically *YouTube*); and (4) Careers in Agricultural Communications - career opportunities in [state], the United States, and internationally, utilization of agricultural communications skills in specific segments of agriculture, and information about agricultural practices and production.

Once the curriculum was developed, project faculty met with teachers from participating programs to provide curriculum training and to schedule the mobile classroom visit. Teachers were given access to the curriculum via printed document, electronic format on flash drive, and on the [university] departmental website. Additionally, a pre-test and post-test for each content area, and a cumulative delayed post-test were administered to measure knowledge growth. High school students participated in a full day, experiential learning activity where they applied knowledge learned in curriculum units to create a three to five minute promotional video about agriculture. Prior to shooting the video [university] faculty ensured that students' storyboards were complete and focused on an agricultural topic that could be shot and edited during the one day mobile classroom visit. During the mobile classroom visit, high school students used SLR cameras and camcorders to capture the elements of their storyboard. After shooting, students used laptops, with Adobe Photoshop and Premier Pro, housed in the mobile classroom, to edit their raw photos and video, combining the visual formats, and add titles, music, and text. Then upon completion and rendering of the videos the students' projects were posted to *YouTube*.

Results to Date/Implications and Future Plans/Advice to Others

Agricultural communications curriculum in four specific contextual areas was developed and tested in high school agriculture courses. The curriculum was intended to be taught in a two week time frame. The curriculum served as a framework and knowledge base for the mobile classroom experience. The mobile classroom was created using a 7x16 foot utility trailer with laptops, SLR cameras and camcorders. The project is currently in Phase I - pilot testing which included four high schools in [state]. In 2011, Phase II will be launched and the program will be delivered to 12 to 15 additional high schools. Continual program evaluation will occur throughout the project. All university agricultural education and communications units can create an environment to train secondary teachers and students about the role of visual, electronic media to promote agriculture. If funds are limited, a mobile classroom can be created without a trailer. University faculty can complete the project utilizing two to five laptops, three to six SLR cameras, and two to five camcorders.

Cost and Resources Needed

A federal grant was secured to complete this project. Approximately \$50,000 in funds were used to launch the visual communications mobile classroom in [state]. Laptops with Adobe Premiere Pro and Photoshop, SLR cameras, and video equipment were purchased, and a utility trailer was modified to house three to five student workstations and an instructor station. Other institutions could launch a similar, but downsized version of the program for \$10,000 to \$15,000.

References

- Bailey-Evans, F. (1994). *Enhancing the agricultural communications curriculum: A national Delphi study*. Unpublished master's thesis, Texas Tech University, Lubbock.
- Barry, A. S. (1997). *Visual intelligence: Perceptions, image, and manipulation in visual communication*. Albany, NY: State University of New York Press.
- Lester, P. M. (1995). *Visual communications: Images with messages*. Belmont, CA: Wadsworth Publishing, 55-140
- Osborne, E. W. (Ed.) (n.d.). *National research agenda: Agricultural education and communication, 2007-2010*. Gainesville: University of Florida, Department of Agricultural Education and Communication.
- United States Department of Education (US DOE). (1996). Executive summary: Archived information. Retrieved November 1, 2010, from <http://www2.ed.gov/about/offices/list/os/technology/plan/national/execsum.html?exp=6>
- Weber, S. (2006). Concerning images. *Concordia University*. Retrieved on April 8, 2006 from: <http://iirc.mcgill.ca/static/methodology/about.html>, 1-4.

**A Model for Integrating Critical Thinking and Emotional Intelligence into Leadership
Curricula**

Jason Davison
j.davison@ufl.edu
University of Florida
PO Box 110540
Gainesville, FL 32611
352-392-0502

Nicole Stedman, PhD
nstedman@ufl.edu
University of Florida
PO Box 110540
Gainesville, FL 32611
352-392-0502

A Model for Integrating Critical Thinking and Emotional Intelligence into Leadership Curricula

Introduction

A majority of recognized leadership theories espouse the importance of utilizing cognitive and relational skills. These skills help leaders build trust with followers and illustrate they have not only the knowledge and competency to perform tasks necessary for their leadership role, but also the relationship frameworks necessary to inspire and motivate individuals to achieve set goals. According to Paul (1990), task-oriented and relationship-oriented skill sets have been the main focus of educators in academia. Facione's (1990) research divided cognitive skills into two facets: dispositions and skills. Paul (1984) and Tavis and Wade (1987) agreed on the relevancy in the inclusion of disposition in relation to critical thinking. These facets work in conjunction to develop a complete, well-rounded view of the internal processes of critical thinking.

Stedman and Andenoro (2007) also linked critical thinking disposition to emotional intelligence skills and leadership behaviors. Elder (1997) noticed this link by stating that when working to develop a student's emotional intelligence one must focus on developing critical thinking skills and creating the mindset to utilize those skills.

The importance of developing these skills has been widely supported by agri-business and supported the need for agricultural leadership programs in higher education (Aldrich, 1988). The development of critical thinking disposition has been viewed by many as a desirable but elusive trait, and one difficult to achieve within the confines of the classroom. Kitchener and King (1995) suggested that skills and dispositions are mutually reinforcing and should be taught and modeled together as part of a development approach to leadership. The question remains, however, how does the need for improving critical thinking disposition in students align with the educational model for leadership development?

How it Works

Effective leadership development instruction must focus on positively influencing a student's skill set in critical thinking and emotional intelligence. Two main parts exist to the model for leadership development in a student. First, the student enters a leadership program possessing some basic inherent traits and skills. These traits and skills are interconnected and offer the foundation to build additional leadership skills. A student's critical thinking disposition affects the way he or she utilizes and applies critical thinking skills. A student's propensity to use their own critical thinking disposition and skills allows for a greater understanding of how to control and manage their emotions and relationship with others. This understanding builds a student's emotional intelligence, and allows for better interaction between other individuals and improved leadership behaviors. These experiences offer an individual the opportunity for self-reflection and evaluation which is a main component of critical thinking disposition.

Second, the instructional approach for leadership development should mirror and strengthen the student's natural learning cycle of leadership. Leadership development curriculum can accomplish these goals by concentrating on appropriate instructional methods, teaching proper application of various leadership theories, personal and task reflection, and promoting leadership experiences. These instructional devices used in an interactive and relational way

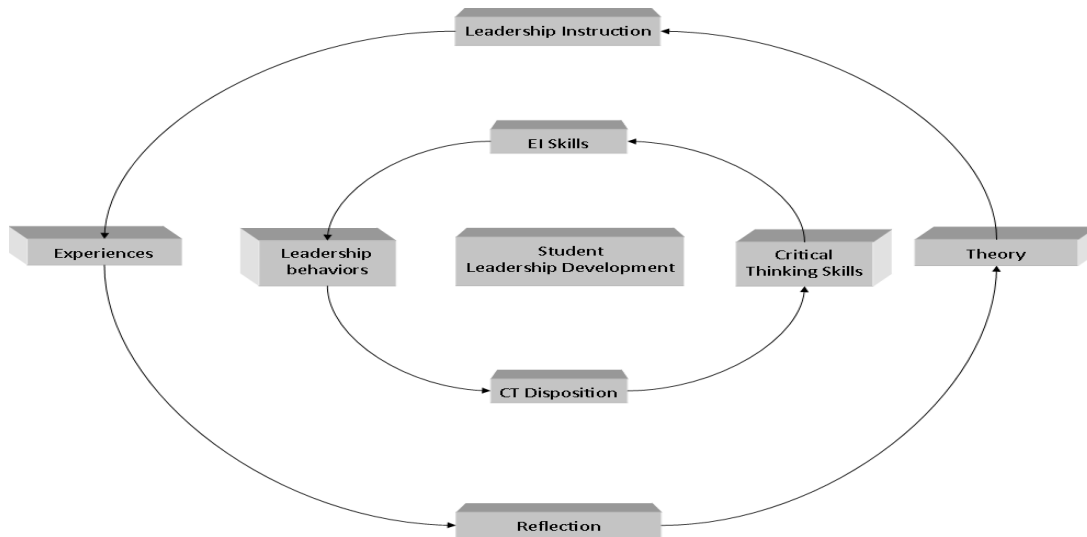

Figure 1: Model for Incorporating Critical Thinking and Emotional Intelligence into Leadership Curriculum. allow a way to stimulate and strengthen a student’s existing leadership skill set. This model is conceptualized in Figure 1.

Results to Date and Implications

During the past three years there has been a purposive integration of critical thinking and emotional intelligence instruction in a series of courses offered at a large southern land grant institution. Faculty for these courses have shown evidence of instruction through course lecture, assignments, discussion, and project-based experiences. Although data is still being collected on students associated with the courses, the faculty believe that significant gains will be made in the areas of critical thinking skill development, emotional intelligence skill development, resulting in increased positive leadership behavior and ultimately, critical thinking disposition change. The proposed model identifies these factors as integral to student leadership development.

The effects this model will have on the pedagogy methods of leadership development programs will bring increased importance in attempting to improve the critical thinking disposition of students. It is unrealistic to assume changing a student’s critical thinking disposition can be achieved over the span of a single leadership class. In order to effectively improve disposition, a more longitudinal approach must be established during the student’s tenure in a leadership program. It will also be increasingly more important for curriculum and courses within the program to focus on improving critical thinking disposition earlier in the leadership program; since students with a stronger initial disposition toward critical developed greater critical thinking skills towards their studies than did those with a weaker initial critical thinking disposition (Facione, 2000).

Future plans

Future plans are primarily directed at continued inclusion of these skill sets in leadership curricula for students pursuing a leadership specialization. Faculty plans to collect data to show long-term effects of this model on student leadership development.

Costs/ Resources needed

The only costs associated with this model is the time needed by instructors to evaluate and reflect on changes in pedagogy methods needed to facilitate a classroom dynamic that initiates an environment more conducive to utilizing and improving critical thinking disposition. However, it is also necessary to establish faculty's comfort and competence with the level of instruction necessary to impart change in critical thinking and emotional intelligence.

References

- Aldrich, D.G. (1988). *Understanding agriculture: New direction for education*. Washington, DC: National Academy Press
- Elder, L. (1997) Critical thinking: The key to emotional intelligence. *Journal of Developmental Education*, 21(1), 40.
- Facione, P.A. (1990) *Critical thinking: A statement of expert consensus for the purposes of educational assessment and instruction*. Millbrae, CA: California Academic Press.
- Facione, P.A., Facione, N.C., Giancarlo, C.A. (2000). The disposition toward critical thinking: Its character, measurement, and relationship to critical thinking skill. *Informal Logic*, 20(1), p. 61-84
- Paul, R.W. (1984). Critical Thinking: Fundamental to education for a free society. *Educational Leadership*, 42(1), 4.
- Paul, R.W. (1990). *Critical thinking: What every person needs to survive in a rapidly changing world*. Rohnert Park, CA: Center for Critical Thinking and Moral Critique, Sonoma State University
- Stedman, N. & Andenoro, A. (Winter, 2007). Identification of relationships between emotional intelligence skill and critical thinking disposition in undergraduate leadership students. *Journal of Leadership Education*, 6(1), p. 192-207
- Wade, C. & Tavris, C. (1987). *Psychology* (1st ed.). New York: Harper and Row

Innovative Idea Poster Submission, 2011 AAAE Southern Region Conference

A Model for Program Planning and Evaluation for School-based Agriscience Education

Christopher M. Estep
Graduate Assistant
Agricultural Education & Communication
University of Florida
310 Rolfs Hall PO Box 110540
Gainesville, FL 32611-0540
352-392-0502 X 238
cestep@ufl.edu

Andrew C. Thoron
Assistant Professor
University of Illinois
137 Bevier Hall, MC 180
905 S. Goodwin
Urbana, IL 61801
(217) 333-1312
thoron@illinois.edu

A MODEL FOR PROGRAM PLANNING AND EVALUATION FOR SCHOOL-BASED AGRISCIENCE EDUCATION

Introduction/Need for Innovation

Agricultural Education teachers have an abundance of unique features to consider when starting or transitioning into a new school-based agriscience program. Lee (2000) indicated that program planning consists of designing and implementing all aspects of the school-based agricultural education program. Phipps, Osborne, Dyer, and Ball (2008) described that beginning teachers have the task of building or planning for courses of study, facilities and resources, community and professional relationships, promotion of the program, advisory councils, and budgets. Phipps et al. outlined effective ways to accomplish individual total program tasks and provided specific steps needed to implement many of the program planning concepts for school-based agricultural education. Furthermore, a course devoted to program planning is commonplace in agricultural education. However, even with specific coursework that builds the knowledge of program planning and step-by-step program implementation outlined in publications; Myers, Dyer, and Washburn (2005) found new teachers knew what needed to be done but perceived themselves as inadequate to achieve the tasks. A visual model and development of an effective way to efficiently evaluate needs and success of a school-based agriscience program will aid beginning teachers in setting realistic priorities and making clear evaluations their first two years in developing their agriscience program.

How it Works

The researchers propose a visual model for beginning agriscience teachers to plan and evaluate program features as outlined by Phipps et al. (2008). This model will aid in planning for the upcoming school year followed by an end of year evaluation strategy. The first consideration is at the community level through identification of community needs. Beginning or transitioning teachers must have an appreciation for the goals and needs of the community and stakeholders. The initial community needs profile will drive the implementation of the planning model. Upon assessing the community needs, the four categories identified for total program planning are: 1) facilities, 2) public relations, 3) teaching, and 4) FFA/SAE. Each category contains a needs assessment stage, planning stage, action stage, and evaluation stage. The model guides agriscience teachers through assessing each category's needs, prioritizing what needs to be accomplished, stages a frame for implementation, and indicates the need for evaluation of yearly progress. The four categories were commonly outlined in the literature (Phipps et al.) in addition to researcher personal experiences as beginning agriscience educators.

Results/Implications/Future Use

The model has been distributed to pre-service teachers currently in their internship program at a STATE university. The researchers plan to receive feedback from the pre-service teachers at the completion of their intern experience, incorporate received feedback, utilize the model with the same group of pre-service teachers during their first year of teaching, gather feedback, adjust if needed, and gather data on model effectiveness. It is the plan of the researchers to share this model with the profession to incorporate teacher educators' ideas into the model so that it may be used in teacher preparation curriculum and by beginning or transitioning teachers across the United States. The model will be presented at the Southern Region AAAE Conference, and revisions will be made according to suggestions offered by peers. The ultimate goal of the model is effective ease of use and understanding by beginning agriscience teachers as a reference tool when planning their school-based agricultural education program.

Costs/Resources Needed

No costs are associated with this model. This model would be most effectively used in conjunction with the Phipps et al. (2008) text in a teacher preparation curriculum.

References

Lee, J. S. (2000). *Program planning guide for agriscience and technology education* (2nd ed.). Upper Saddle River, NJ: Pearson Prentice Hall Interstate.

Myers, B. E., Dyer, J. E., & Washburn, S. G. (2005). Problems facing beginning agriculture teachers. *Journal of Agricultural Education*, 46(3), 47-55.

Phipps, L. J., Osborne, E. W., Dyer, J. E., and Ball, A. (2008). *Handbook on agricultural education in public schools* (6th ed.). Clifton Park, NY: Thomson Delmar Learning.

A Philosophical View for Using Second Life™ as a Teaching and Learning Tool

Allyson McGuire
Graduate Assistant
University of Arkansas
Department of Agricultural Extension and Education
205 Agriculture Building
Fayetteville, AR 72701
(479) 575-2596 Phone / (479) 575-2610 Fax
amcguir@uark.edu

Leslie D. Edgar
Assistant Professor of Agricultural Communications
University of Arkansas
Department of Agricultural Extension and Education
205 Agriculture Building
Fayetteville, AR 72701
(479) 575-6770 Phone / (479) 575-2610 Fax
ledgar@uark.edu

Don W. Edgar
Assistant Professor of Agricultural Education
University of Arkansas
Department of Agricultural Extension and Education
205 Agriculture Building
Fayetteville, AR 72701
(479) 575-2037 Phone / (479) 575-2610 Fax
dedgar@uark.edu

Kristin M. Pennington
Graduate Assistant
University of Arkansas
Department of Agricultural Extension and Education
205 Agriculture Building
Fayetteville, AR 72701
479-575-4352 / (479) 575-2610 Fax
khopper@uark.edu

A Philosophical View for Using Second Life™ as a Teaching and Learning Tool

Introduction/Need

Second Life© (SL) is an internet-based virtual world released by its parent company, Linden Lab, in 2003. In 2008, SL was adopted by numerous educational entities and began to be used in educational instruction and training. Virtual communities, as a social laboratory for learning, can provide nearly endless possibilities for students. SL allows instructors to implement tools for interaction and participation among users.

In a SL virtual classroom setting, students and educators can engage in online discussions using instant text messaging or voice chat. Within these discussions there can be question and answer sessions and electronic infrastructure can be put in place to insert and retrieve files such as word documents, PowerPoint presentations and videos. Because online learning participants can visualize themselves and others through their self-created avatars, it creates a presence not available in traditional modes of distance learning. SL limits no imagination, and its virtual space is boundless, allowing educators greater ability and freedom to include real-time, professional-centered instruction applicable to a student's future professional field.

Johnson (2005) noted “the rise of the Internet has challenged our minds in three fundamental and related ways: by virtue of being participatory, by forcing users to learn new interfaces, and by creating new channels for social interaction” (p. 119). Through brazen vision, software designers have developed spaces imitating real life. Virtual reality, the use of computers to simulate a real or imagined environment that appears as a three-dimensional space, has increasingly become a more comfortable and natural concept (Dooley, Lindner, & Dooley, 2005).

A Philosophical Approach to How it Works

Social networking and virtual community websites allow users to create a virtual self (avatar) and to project themselves to the Internet world without others knowing their true identity. With the advent of technological advances and the exposure of younger generations to digital media from birth, the need for personalized and adaptive education is deemed necessary. Learners should participate in activities allowing them to learn and understand skills. “Learners must also be taught in a variety of context for learning to be transferred” (Edgar, 2007, p. 13).

Using digital learning environments can potentially cater to the needs of students by providing learning activities which are individualized to meet their needs and characteristics. “It is evident that the use of virtual worlds...creates a range of pedagogic possibilities that potentially can benefit all” (Ball & Pearce, 2009, p. 58). In an age characterized by information overload, it's imperative that students adapt to different problems and settings, and be flexible in applications of learning (Edgar, 2007). Social learning theory emphasizes the importance of observing and modeling behaviors, attitudes, and emotional reactions of others (Bandura, 1977). The structure of SL is set up to allow for various types of communication. Such features available in SL include: text chat, instant messaging, note cards, voice chat, camera, snapshots, and creation and modification of objects (Love, Ross, & Wilhelm, 2009).

Creating a SL learning environment may be an answer to some of the challenges related to learning outside the formal classroom. The ability to provide interactive, real-world scenarios

can reduce the impact and cost of education while diversifying the student base. Traditional classroom-based instruction can provide cognitive understanding and a review of relevant theory, but it does not always provide students with experiential opportunities to develop the deep understanding, competence, and positive attitude needed to effectively apply educational learning to schema. While students have the ability to be self-directed and individually experience the simulated classroom or learning setting, it is also possible for educators to have a more interactive role with each student. Instead of students sitting in a classroom desk, they are logged onto a computer and are engaged in a virtual world. SL feeds into the nature of students who have and will grow up in a generation that is digital.

Second Life© (SL) is a 3-D virtual world that allows anyone to build an interactive experience or create educational training. In 2005, support systems were created to assist educators in SL. By August 2006, more than 80 SL islands were dedicated to educational and academic use (Livingstone & Kemp, 2006). Educators have identified several characteristics that make SL a valuable educational environment, (a) strong sense of collaborative community, (b) interoperability, (c) interactive learning experiences that are hard and expensive to duplicate in real life, and (d) ability for true collaboration (Bransford & Gowel, 2006).

Results to Date/Implications

Not all educational opportunities are best executed in an environment such as SL. While potential uses for SL and education are being explored, designed, and evaluated, it may be a means from disseminating instruction beyond the traditional classroom. Incorporating SL into the classroom will allow students to experience educational opportunities not possible in the traditional classroom. In a SL virtual classroom setting, students and educators can engage in online discussions and instruction through a variety of communication channels and teaching methods. An additional attraction to using SL is the ability for social interaction with students, instructors and people scattered across the globe. SL does have the ability to reinvent, transform, and enhance education.

Future Plans/Advice to Others

SL is an interactive tool that should be explored in educational programs seeking to positively impact learners. Although relatively inexpensive, the amount of time and effort invested will result in a more positive perception held by users through skill acquisition and immersion into the technological aspects of this venue. Digital Natives display easy adaptation of concepts and skills needed to maneuver and accomplish tasks in SL. When creating asynchronous courses, SL does require instructors to lay out courses in an effective manner to ensure student engagement.

Costs and Resources Needed

SL can be used collaboratively with other colleagues or industry professionals to strengthen learning and educational impact. Incorporating SL into the classroom allows students to experience virtual field trips, attend or share guest lecturers and/or student presentations, or participate in simulations. With a bit of creativity on the part of both the instructor and the students, the virtual classroom can provide enriching experiences with minimal cost. Building instruction in SL can vary from no cost to thousands of dollars depending on instructional plans and use. However, with \$100 or less, a few SL contacts and an open mind you can engage your students in meaningful virtual learning experience.

References

- About Linden lab - the culture.* (2009). Retrieved November 1, 2009, from <http://lindenlab.com/about/culture>
- Ball, S. & Pearce, R. (2009). Inclusion Benefits and Barriers of “Once-Removed” Participation. In Wankel, C. & Kingsley, J (Eds), *Higher Education in Virtual Worlds* (pp. 47-63). Bingley, UK: Emerald Group Publishing Limited.
- Bandura, A. (1977). *Social Learning Theory*. New York: General Learning Press.
- Dooley, K. E., Lindner, J. R., & Dooley, L. M. (2005). *Advanced Methods in Distance Education*. Hershey, PA: Information Science Publishing.
- Edgar, D. W. (2007). *Learning theories and historical events that have changed instructional design and education: Recitation literacy towards extraction literacy*. Unpublished manuscript.
- Johnson, S. (2005). *Everything Bad is Good for you*. New York City, NY: Penguin Group.
- Livingstone, D. & Kemp, J. (2006). Words from the chair. *Proceedings of the Second Life Education Workshop at the Second Life Community Convention*, San Francisco, CA. Retrieved online at <http://www.simteach.com/SLCC06/slcc2006-proceedings.pdf>
- Love, E., Ross, S., & Wilhelm, W. (2009). Opportunities and Challenges for Business Education in Second Life. In Wankel, C. & Kingsley, J (Eds), *Higher Education in Virtual Worlds* (pp. 65-82). Bingley, UK: Emerald Group Publishing Limited.
- Second life.* (2009). Retrieved October 1, 2009, from <http://secondlife.com>

A Qualitative Evaluation of a Cross-Cultural Immersion Program for Extension Educators

Jennifer Brown
University of Georgia
220 Hoke Smith Building
Athens, GA30602
270-535-5198
Jbrown10@uga.edu

Maria Navarro
mnavarro@uga.edu

Dennis Duncan
dwd@uga.edu

Nick Fuhrman
Fuhrman@uga.edu

A Qualitative Evaluation of a Cross-Cultural Immersion Program for Extension Educators

Introduction

Some states with large influxes of diverse populations have recently established cross-cultural immersion experiences to increase the cultural competence of their staff. The Hispanic population in [State] has grown radically in the last decade, and the need for its Extension personnel to gain a broader knowledge of the new population they are serving has become increasingly evident. With the hope of building the self-efficacy of agents to serve Hispanic populations, the [state] Cooperative Extension established a cross-cultural immersion program in 2002. The program developed in this state is the focus of this evaluation.

The program provided international experiences for extension educators that allowed them to immerse themselves in a Latin American country for two weeks. These two weeks were devoted to enhance the participant's ability to understand the culture and situation of the Hispanic population, and cultivate the skills to address the needs that Cooperative Extension can meet.

How it works/methodology/program phases/steps

In order for the Cooperative Extension System to remain effective in its position to spread research-based information to the public, Extension leadership must provide an atmosphere that permits professionals to continually develop their cultural competence. "Leadership must provide the environment that allows staff to learn new skills for designing programs and to employ people from historically exclusive groups, while staff has to engage in the personal development work that will build a welcoming environment" (Schauber & Castania, 2001, para. 4). Cooperative Extension Leadership in [state] has determined that recognition of the global community is a priority, and has established cultural exchange and immersion programs. In these programs, extension professionals experience and live in a different culture, practice cross-cultural communication skills, and enhance their cultural competence.

As part of a formative and summative evaluation of the program, the researchers sent a survey instrument to all available past participants (2002-2008) of the Cross-Cultural Immersion program (sampling frame of 47). The instrument had both quantitative and qualitative questions. This poster is used to report the responses (by domain) to the three open-ended questions (qualitative data), which asked about what aspects of the program most impacted participants, suggestions for program improvement, and general comments about the program. The responses were analyzed using domain analysis and grouped into 6 dominant domains, for each question, based on the frequency of the response.

Results to date/implications

Thirty two people responded to the survey (68% response rate). Three questions (open-ended format) were posited to respondents. Responses from these questions were further analyzed and delineated into 6 categories for each question using domain analysis. Each question and associated domains (in order of prevalence) are presented below. Specific pieces of supporting evidence (raw data quotes) will be presented on the poster.

1. *Please provide an example of one particular aspect of the Cross Cultural Immersion program that greatly influenced you.* Homestay, Learning About the Culture, In-Field Visits, Learning the Language, Programming, and Miscellaneous.
2. *What is one suggestion that you have for the organizers of the Cross Cultural Immersion program?* Language Classes, Continuation of the Program, Additional Preparation for the Trip, Planning for Post-Trip Implementation, Free Time/Flexibility in Schedule, and Miscellaneous.
3. *Is there anything else you would like to share about the Cross Cultural Immersion (CCI) program and your CCI experience?* Great Experience, Professional Benefit, Personal Benefit, Globalization, Expansion and Continuation, and Miscellaneous.

Future plans/advice to others

Although respondents had a broad array of thoughts and feelings about their Cross-Cultural Immersion trip, the general consensus was that the program was a positive force for education and change in Cooperative Extension. This further demonstrates that “the new millennium will offer many challenges to Extension. Recognition of the global community we inhabit and share with partners around the world will become an increasing priority” (Ludwig, 1999, para. 20). [state] Cooperative Extension has made vast strides with their Cross-Cultural Immersion program to support their Extension agents and professionals in efforts to become more accepting and tailored to the global community that we inhabit. It is recommended that future inquiry and research be pursued to better define the efficacy of Cross Cultural Immersion programs.

Costs/resources needed

Funding for the initial years of the Cross-Cultural Immersion program participants was provided in part by the USDA-CSREES International Science and Education Competitive Grants Program (Ames & Atilas, 2008). This allowed participants the freedom to experience a different culture without the burden of expenses.

References

- Ames, G. C. & Atilas, J. H. (2008). *Learning for life: Cross-cultural studies to enhance outreach programming for [State's] changing demographics*—A focus on Mexico. The University of [state] internal document (formerly available at <http://www.uga.edu/internationalpso/mexico08report.html>).
- Ludwig, B. (1999). Globalizing Extension Professionals. *Journal of Extension*, [On-Line], 37(4). Available at: www.joe.org/joe/1999august/rb5.html.
- Schauber, A. C., & Castania, K. (2001). Facing Issues of Diversity: Rebirthing the Extension Service. *Journal of Extension*, [On-Line], 39(6) Article 6COM2. Available at: www.joe.org/joe/2001december/comm2.php.

Better Teamwork by Knowing Yourself & Other's Personalities

David Jones
North Carolina State University
Campus Box 7607
Raleigh, NC 27695
919-513-2187
dwjones@ncsu.edu

Better Teamwork by Knowing Yourself & Other's Personalities

Abstract

The foundation of teamwork is the ability to work with others. The realization that most actions or reactions by individuals are due to personality and are not personal can help to decrease team conflicts. Using a personality profile and understanding how different personalities approach different situations can help to increase team performance and productivity. How also can we educate the public, change the image, recruit and retain American society about agriculture and the agriculture industry?

Introduction

In the National Research Council's report, "Understanding Agriculture: New Directions for Education" also known as the *Green Book*, secondary education and its importance to public education was researched and reported. Findings of this report concluded that there was a need for "systematic instruction about agriculture beginning in kindergarten or first grade and continuing through twelfth grade." The report continues with, "Colleges of agriculture, particularly in land-grant universities, should become more involved in teacher preparation and in-service education programs, curriculum reform, and the development of instructional materials and media." p.7

Many Agricultural Education faculty members employed by land-grant universities have a split appoint. A split appointment could mean that part of their schedule is teaching, part is research and the remainder is extension or outreach. Traditionally, the extension or outreach aspect of a faculty member's appointment has been to work with the cooperative extension or some other outreach program. The topic of this innovative idea is to extend the university knowledge and reach into elementary schools to not only encourage teamwork and cooperation, but to network agriculture education programs and elementary schools together.

Purpose and Objectives

The purpose of this program was to take agriculture education faculty into elementary schools and to introduce them to leadership topics and discussions that will promote teamwork, cooperation and a better understanding of personalities, both personally as well as others.

Methods

Early in the fall semester of 2009 an agriculture faculty member of a major land-grant university was contacted to discuss the possibility of conducting a workshop for an elementary school in regards to personalities and how personalities effect teamwork and the work environment. After several discussions between the principal of the elementary school and the faculty member a date was confirmed and the faculty member made arrangements to present to the faculty and staff of the elementary school. The principal of the elementary school arranged for all faculty and staff of the school to be present in the media center for the workshop. Participants ranged from vice-principals to the janitor and all other members of the school community. Included in the participants were members from the county schools system waiting to present their own workshop after the "personalities" workshop.

The agricultural educator's presentation lasted for approximately 90 minutes and included lecture, activities, fun and laughter. All members participated in some way. At the conclusion of

the workshop an evaluation form was passed out by the principal in the form of a “plus/delta” form (things that went well and things that needed to change). There were very favorable comments throughout and so the principal considered the event a success.

Results and Discussion

Participants of the workshop determined their own personalities and learned how it can effect what they do and how they interact with others. Participants also were given hints and suggestions as to how to know and understand others personalities that they work with and have significant relationships with.

Since the initial presentation the agricultural educator has been requested to present this same workshop to the entire school districts Instructional Resource Teachers, approximately 200 participants. After the presentation to the IRT’s of the district the facilitator has made 2-3 presentations per month to elementary schools around the district presenting the workshop. This workshop is seriously building community and teamwork within the elementary schools, as well as building a network and cooperative atmosphere for future dealings between the agricultural industry, the university and the elementary school.

Conclusions/Recommendations

The most important part of this whole concept is getting people to understand that there is more to individuals than meets the eye. Personalities are complex and sophisticated. Agricultural educators must understand that not everyone has the passion for agricultural education. This allows an opportunity for agricultural educators to get a foot in the door of our elementary schools discussing an important topic which is important to everyone, “Leadership.” This first point of contact has led the facilitator to create a second round of workshops that are currently being presented as a “part 2” to the elementary schools that participated in the initial presentations.

Changing the population’s perception of agriculture and agriculture education is one of the first steps if we are to work on the sustainability, recruitment and retention in our industry. Our industry being Agriculture.

References

Understanding Agriculture: New Directions for Education. Committee on Agricultural Education in Secondary Schools. Board of Agriculture. National Research Council. National Academy Press, Washington, D.C. 1988

Breaking Barriers for Beginning Hispanic Farmers and Ranchers

Stephanie Herreros, Dr. Robert Williams, Dr. Jose Lopez, Dr. Curtis Jones, and Dr. Mario Villarino

Texas A&M University- Commerce
P.O. Box 3011
Commerce, TX 75429

469-544-9481

Vdesteps2glory@yahoo.com

Breaking Barriers for Beginning Hispanic Farmers and Ranchers

Introduction/Need for Innovation

Hispanic farmers and ranchers in the United States lack awareness of agricultural programs, agencies, organizations, production resources, management practices as well as in finances and marketing which is due to several constraints and barriers. These may include language barriers, institutional discrimination, limited access to information on market and loan programs, and a lack of culturally similar role models who are farm and ranch owners or operators. Hispanic farmers and ranchers require special needs for accessing and understanding information regarding these topics (Ariza and Sulvedi, 2009); (Christiansen and Grajales-Hall, 1997).

The purpose of this project is to provide Hispanic farmers and ranchers who are seeking to establish their own farm or ranch operation with relevant training and greater access to information, organizations, and agencies involved in support for farmers and ranchers. The target audience for this project will consist of prospective and beginning Hispanic farmers and ranchers within the targeted county, in which a large amount of its agricultural income is derived from milk sales and dairy products. The project involves recruiting members from the target audience, providing relevant training through seminars, workshops, presentations, and on-farm demonstrations.

Methodology

This is a three-year outreach project designed to assist prospective and beginning Hispanic farmers and ranchers by utilizing novel approaches. Seminars, workshops, presentations, and demonstrations will be conducted in Spanish or translated into Spanish, the primary language of the participants. Instructional materials will be provided in Spanish and English. Presentations and demonstrations will be developed and delivered by qualified professionals who are fluent in both Spanish and English. The process will include developing cultural sensitivity training for agricultural agencies, businesses, and lenders to improve public relations with Hispanic clientele. Cultivating professional and social networks for beginning Hispanic farmers and ranchers is another goal of the project.

The population for this study consists of small-scale Hispanic-Latino farmers and ranchers within the targeted county who are interested in owning or managing their own operation. Much of the county's agricultural income is from dairy production. Approximately 750 Hispanic farm workers are employed in these dairy operations of which several are engaged or interested in part or full-time operations of their own.

This project will also utilize computer-based response systems with remote responders in order to gain greater audience participation during presentations and training. This will allow more audience participation by allowing anonymous responses to questions which will be given to obtain an assessment of their understanding and knowledge. The process will also entail gathering the audience's concerns, suggestions, goals, and ideas to prioritize topics for presentation.

Results to Date/Implications

The first phase of this project is currently underway. Project faculty are recruiting graduate assistants and staff members for the project as well as advisory committee members. Initial contact with members of the target audience has been made to determine promotional strategies and prioritize topics for initial training. A major constraint thus far has been the recruitment of graduate assistants and staff who are fluent in both English and Spanish and who also have agricultural-related degrees.

Future Plans/Advice to Others

The first year of this project focuses on prioritizing, developing, and delivering relevant training and information matching participants' interest and needs in business management and production techniques. It also includes cultural sensitivity training for agricultural lenders, agencies, and organization serving Hispanic clientele. During the second and third year additional training will be provided on other complementary topics related to owning and operating agricultural and agribusiness operations. During the second and third year the outreach programs will expand to include adjoining counties.

Cost/Resources

This project will include a full time extension associate, half-time administrative assistance, and five graduate assistants. Therefore, much of the budget will go to salaries and benefits as well as release time for project faculty and director. This is a grant-funded project with a total budget exceeding \$800,000 for the three-year period. The project is funded under the USDA-NIFA Beginning Farmer and Rancher Development Program.

References

Ariza, B.L & Suvedi, M. (2009). Understanding Hispanic farmers and their educational needs: A case of southwestern Michigan. *Proceedings of the 25th Annual Meeting of the International Association of Agricultural and Extension Educators*. San Juan, Puerto Rico.

Christiansen & Grajales-Hall (1997). *Working with Asian and Hispanic Limited Resource Farmers and Ranchers*. Natural Resources Conservation Services-Social Sciences Team Technical Report, Release 4.1

By Choice, Not by Chance Art Gallery Exhibit

Submitted to:

Southern Region Agricultural Education
2011 Conference

Submitted by:

Billy J. Riley
Agricultural Education
University of Kentucky
College of Agriculture
500 Garrigus Building
Lexington, KY 40546
859-257-3153
billy.j.riley@uky.edu

Stacy K. Vincent
Agricultural Education
University of Kentucky
College of Agriculture
505 Garrigus Building
Lexington, KY 40546
859-257-7588
stacy.vincent@uky.edu

By Choice, Not by Chance Art Gallery Exhibit

Introduction/Need for Innovation or Idea

Agricultural education has historically demonstrated its ability to adapt to changing trends and student demographics. However, in order to maintain its current growth, the profession must continue to be engaged in developing methods to effectively teach and connect to the full spectrum of students in today's schools (Ball, Dyer, Osborne, & Phipps, 2008). As the demographics of students today change, agricultural education must recognize and capitalize on the benefits that diversity brings to the profession and its students. Thinking in a diverse manner benefits a student's cognitive and personal development, broadens perspectives, and sharpens critical thinking skills (Banks, 1994; Warren & Alston, 2007). However, barriers exist that hinder the diversification and growth of thinking and the agricultural education profession. One such barrier is that of social influence. Research conducted showed that parents and/or guardians have the most influence on a student's decision to enroll in a post secondary program in agriculture (Esters, 2007). Public education about the profession can greatly influence the diversification process of its student body.

To fill a literacy gap toward agricultural education and in order to meet the needs of a changing classroom culture, the profession must utilize new teaching methods and implement new techniques, while expanding cognition. Donald (2006) argues that art is universal to all societies and can provide a teaching medium that bridges the multiple facets of students at a university and enhance their understanding of agricultural education. Initially, the viewer, an outsider of agricultural education, may not understand the context of artwork and be incapable of interpreting its culturally significant meaning, yet still enjoy certain aspects of the piece (Davies, 2000). Heath (2006) believed that through art, a bridge is created that connects the viewer's relevant characteristics to the artist's meaning of them. Therefore, linking the visual experience to the viewer's known genre, event, or tradition, creating an understanding of the professional field. Through art, can agricultural education educate others about the profession, change the social perception of agricultural education and expand the opportunity for a more diverse classroom enrollment?

How It Works/Methodology

During the beginning of the semester, undergraduates in a Foundations of Teaching course explored the perceptions and knowledge that students across a college campus have about agricultural education. Students focused their interviewing population to the university students, faculty, and staff who were outside the field of agriculture. Results identified the general student body's lack of knowledge and understanding of agricultural education. In order to educate the community and expand the pre-service teachers' cognitive processes, the class was challenged to organize, create, and facilitate an art show. The show was devoted to providing an opportunity for pre-service teachers to educate the general public about agricultural education through a form of art.

Because the definition of art remains a philosophical problem, as Danto (2000) contends, pre-service teachers can express their profession in a variety of means such as painting,

sculpture, photography, videography, song, and poetry. During the exhibit, pre-service teachers displayed and defended the works by articulating its various aspects to their field. The art showcase was held in an art gallery and publicly advertised for the public to view. The pre-service teachers received credit based on their ability to provide meaning and connection of the art to their profession. To determine if learning occurred, viewing guests submitted a pre and post-viewing definition of their interpretation of what agricultural education was.

Results to Date/Implications

Concurrently with bridging the literacy gap, the production and viewing of art cognitively developed the viewer's mindset of agricultural education through perception, working memory, spatial attention, and episodic recall. The pre-service teachers producing and defending their artworks were exercising a number of these cognitive components as well. Students producing works of art reflect not only on their definition and interpretation of their career fields, but also on their identity and the culture from which they came. This metacognitive thinking allowed the pre-service teachers to produce a representation of their profession and gained confidence in expressing their beliefs (Donald, 2006).

Future Plans/Advice to Others

Many universities across the United States enroll students from a variety of cultures and life-styles. As the push for cultural diversity in agricultural education continues, so does the need for public education for the field. This showcase begins a new tradition for future students of the course to continue educating the public about their profession. Each year, students will continue the art showcase as the instructional method for this task. As the showcase continues, the demographics of students enrolling in agricultural education will become more diverse; in turn, strengthening its purpose and justifying its need in today's schools.

Cost/Resources Needed

Expenses for the showcase are minimal. The cost of materials used in the art pieces was the individual student's responsibility. However, students were provided the opportunity to sell their work. Incurred costs not covered by the students were those for refreshments at the public exhibit and advertisement of the art exhibit. The art gallery selected for the exhibit provided display settings and any other materials needed to enhance the art and provide a formal atmosphere.

References

- Ball, A., Dyer, J. E., Osborne, E. W., & Phipps, L. J. (2008). *Handbook on agricultural education in public schools*. Clifton Park, NY: Thomson Delmar Learning.
- Banks, J. A. (1994). *Multiethnic education: Theory and practice*. Boston: Allyn and Bacon.
- Danto, A. C. (2000). Art and meaning. In N. Carroll (Ed.), *Theories of art today* (pp.130-140). Madison, WI: The University of Wisconsin Press.
- Davies, S. (2000). Non-western art and art's definition. In N. Carroll (Ed.), *Theories of art today* (pp. 199-216). Madison, WI: The University of Wisconsin Press.
- Donald, M. (2006). Art of cognitive evolution. In M. Turner (Ed.), *The artful mind* (pp. 3-20). New York, NY: Oxford University Press, Inc.
- Esters, L. T. (2007). Factors influencing postsecondary education enrollment behaviors of urban agricultural education students. *Career and Technical Education Research*, 32(2), 79-98.
- Heath, S. B. (2006). Dynamics of completion. In M. Turner (Ed.), *The artful mind* (pp. 133-150). New York, NY: Oxford University Press, Inc.
- Warren, C. K., Alston, A. J. (2007). An analysis of diversity inclusion in north Carolina secondary agricultural education programs. *Journal of Agricultural Education*, 48(2), 66-78. doi: 10.5032/jae.2007.02066

**COLLEGIATE LEADERSHIP IN AGRICULTURAL STUDENT ORGANIZATIONS:
DEVELOPING A MOTIVATIONAL PERSPECTIVE**

Ms. Andrea Andrews

Agricultural Education & Communication Department
University of Florida
PO BOX 110540
Gainesville, FL 32611
(352) 392-0502 Ext. 244
Andreaa@ufl.edu

Dr. Nicole Stedman

Agricultural Education & Communication Department
University of Florida
PO BOX 110540
Gainesville, FL 32611
(352) 392-0502 Ext. 247
Nstedman@ufl.edu

Dr. Greg Gifford

Agricultural Education & Communication Department
University of Florida
PO BOX 110540
Gainesville, FL 32611
(352) 392-0502 Ext. 239
Ggifford@ufl.edu

Collegiate Leadership in Agricultural Student Organizations: Developing a Motivational Perspective

Introduction

One of the common goals of higher education is to help develop students into leaders (Pennington, 2005), and Colleges of Agricultural and Life Sciences have an opportunity to do so by utilizing the Motivation Sources Inventory (Barbuto & Scholl, 1998) within its student organizations. One of the most prominent reasons students join collegiate organizations is to gain opportunities to develop leadership skills (Hoover & Dunigan, 2004). This indicates a need for College of Agricultural and Life Sciences student organizations to learn how their members and leaders are motivated so they can better understand the ever changing demographics and dynamics of the students these organizations embody.

Agricultural education has strived to offer students diverse ways to develop leadership skills (Brown & Fritz, 1994), and incorporating the MSI is another opportunity to do so. The MSI is a useful tool to study motivation and further student development (Barbuto & Scholl, 1998). This unique approach allows students to discover sources of motivation and how their individual motivation profile impacts their development as a leader.

How It Works

Barbuto and Scholl (1998) developed the Motivation Sources Inventory (MSI) instrument to measure the five sources of motivation included in the integrated model of motivation proposed by Leonard, Beauvais, and Scholl (1999). The proposed five sources of motivation are: Intrinsic Process, Instrumental, Self-concept External, Self-concept Internal, and Goal Internalization. Intrinsic Process motivation is finding pleasure in the work being done and seeing the task as fun. Instrumental motivated individuals seek materialistic rewards such as money or power. Self-concept External motivation seeks acceptance and status because of a need for affiliation and belonging. Self-concept Internal is a source of motivation that comes from within an individual to reinforce personal values and standards through overcoming challenges and personal achievement. Goal Internalization is motivation to achieve a common goal because it supports the individual's beliefs and values and works towards a collective goal.

Students serving within College of Agricultural and Life Sciences student organizations will be asked to complete the MSI along with additional questions related to their personal demographics and characteristics such as age, race, gender, and leadership courses taken or currently enrolled in. Students will discover whether they have a more predominant source of motivation or a distribution among all sources of motivation, and begin to learn how sources of motivation relate to predicting behaviors and how motivation plays a part in developing leaders.

Results

Research shows that students who pursue leadership roles are more successful in continuing to grow in their leadership development than those students who do not (Cooper et al., 1994). When presented with the opportunity, five southern land grant institution ambassador teams used the MSI to further understand the individual motivations of the student leaders within their organization. Students are also better able to stand apart from other graduates as more transformational leaders and reach a higher potential as leaders. Recognizing how individuals are motivated and identifying how motivation impacts leadership, Colleges of Agricultural and Life Sciences will expand interpersonal leadership development opportunities for members and encourage more successful student organizations.

Future Plans

Powell and Agnew (2007) claim that there is an ever growing challenge for student organizations to adapt to meet the needs of their members. We recommend that College of Agricultural and Life Sciences student organizations encourage members to participate in completing the MSI so they can better understand what motivates members and can plan more effective programs, recruit members, and offer leadership development in accordance to what will motivate members to become more involved and stay active.

It is recommended that College of Agricultural and Life Sciences faculty consider taking the opportunity to develop better interpersonal leadership courses through incorporating the MSI into classroom curriculum to encourage students to discover, understand, and utilize their sources of motivation as a developing strength.

Costs

Costs and resources involved are minimal. It is recommended that permission to print and distribute is gained from Barbuto and Scholl. Expenses may be found in paper and printing the MSI. Time requirements should be considered for students to complete the assessment, calculate scores, along with interpreting and communicating MSI scores to College of Agricultural and Life Sciences student organizations members, advisors, and faculty.

References

- Barbuto, J. E., & Scholl, R. W. (1998). Motivation Sources Inventory: Development and validation of new scales to measure an integrative taxonomy of motivation. *Psychological Reports, 82*, 1011-1022.
- Brown, F. W., & Fritz, S. M. (1994). Determining the breadth of leadership and human resource management/development offerings in post-secondary departments of agricultural education. *Journal of Agricultural Education 35*(3), 1-5.
- Cooper, D. L., Healy, M. A., & Simpson, J. (1994). Student development through involvement: Specific changes over time. *Journal of College Student Development 35*(1), 98-102.
- Hoover, T. S., & Dunigan, A. H. (2004). Leadership characteristics and professional development needs of collegiate student organizations. *NACTA Journal, 48*(2), 22-26.
- Leonard, N. H., Beauvais, L. L., Scholl, R. W. (1999). Work motivation: The incorporation of self-concept-based processes. *Human Relations 52*(8), 969-998.
- Pennington, P. (2005). The leadership pie: Grab your piece before it's gone. *Journal of Leadership Education, 4*(1), 75-78.
- Powell, D., & Agnew, D. M. (2007). Student leader preferences: What students want from involvement in student organizations. *NACTA Journal, 51*(2), 11-18.

**Development of an Electronic Clearinghouse of Renewable Energy Curriculum for
Secondary Agricultural Education: A Partnership of Two Departments**

J. Joey Blackburn

Oklahoma State University
459 Agricultural Hall
Stillwater, OK 74078
joey.blackburn@okstate.edu

Marshall A. Baker

Oklahoma State University
459 Agricultural Hall
Stillwater, OK 74078

J. Shane Robinson

Oklahoma State University
457 Agricultural Hall
Stillwater, OK 74078

M. Craig Edwards

Oklahoma State University
456 Agricultural Hall
Stillwater, OK 74078

Ray L. Huhnke

Oklahoma State University
223 Ag Hall
Stillwater, OK 74078
(405) 744-8417

Development of an Electronic Clearinghouse of Renewable Energy Curriculum for Secondary Agricultural Education: A Partnership of Two Departments

Introduction

The United States' dependence on fossil fuels has created a need to research and develop diverse forms of renewable energy (Dillman, 2007). Renewable energies such as wind, solar, geothermal and biofuels are gaining the attention of researchers and policymakers alike. Specifically regarding biofuels, the Energy Independence and Security Act (EISA) of 2007 requires all vehicles to have a combined fleet average of 35 mpg and/or be capable of operating with alternative fuels or alternative fuel blends (Sissine, 2007). Currently, biofuels such as ethanol and biodiesel hold the greatest potential to meet these criteria.

This increasing research and production of renewable energy requires a knowledgeable public (Dillman, 2007). As such, students should be exposed to foundational knowledge of renewable energy at the secondary level. Students should be informed of potential career opportunities as well as the science supporting biofuel technology (Dillman). Teaching the science of renewable energy in the context of agriculture will allow students to obtain technical, science-based, content specific skills (Roberts & Ball, 2009). Therefore, an opportunity exists to integrate biofuel concepts into secondary agricultural education curricula. Currently, in [STATE], two natural curricular venues exist for biofuel integration in agricultural education: Agricultural Power and Technology and Natural Resources (Blanton, Robinson, Edwards, & Huhnke, 2010).

How it Works/Phases

[STATE] University's Department of Agricultural Education, Communications, & Leadership (AECL) is partnering with the Biosystems & Agricultural Engineering (BAE) department on an Experimental Program to Stimulate Competitive Research (EPSCoR) grant. Three phases of renewable energy curriculum integration have been identified. Phase I of the biofuels curriculum integration project in [STATE] agricultural education is underway currently. Specifically, two doctoral students in the AECL department are working to discover what renewable energy curriculum and resources exist. Faculty members of the BAE department are researching several technical areas of renewable energy, with biofuels being a main focus. Research from this department will be transformed into curricular materials for secondary agriculture teachers.

Results to date

To date, two .25 FTE graduate students have invested approximately 25 hours researching available curriculum and resources relating to renewable energy. A list of 35 websites has been developed to serve as a "base of operation" for the project. During Phase I of the research, it was determined that it would be necessary to focus on biofuels curriculum and resources, specifically. The BAE department has provided additional guidance, stating that biofuels relate most directly to the EPSCoR grant agenda. In response to the direction provided, an electronic sampling consisting of ten biofuels resources has been created to disseminate to secondary agriculture teachers. The Biofuels Resource Grid contains the title of the resource, a hyperlink to

the Uniform Resource Locator (URL), and the funding entity of the resource. In addition, the grid contains checkboxes that indicate the resource category. These checkboxes allow teachers to determine if the resource includes lesson plans, assessments, visual aids, worksheets, activities, and if it is a “quality” resource.

Future Plans

Regarding Phase II of the biofuels curriculum integration project, faculty members at [STATE] University have several short and long-term goals. In the short-term, the Biofuels Resource Grid will be disseminated to agriculture teachers. Further, additional Internet search will be conducted to determine if more “quality” resources should be added to the grid. In the long-term, the Biofuels Resource Grid will be expanded to include all types of renewable energy (i.e. wind, solar, geothermal). The grid will then be transformed into a “clearinghouse” website for access by educators. Each resource will be aligned to [STATE] education standards. This will allow agriculture as well as science teachers to access a variety of curriculum resources for the purpose of integrating core concepts of renewable energy and would support emerging STEM education initiatives into their classes (President’s Council of Advisors on Science and Technology, 2010). Integrating core content into agriculture courses provides students a way to understand core subjects better (Roberts & Ball, 2009).

Phase III of the biofuels integration project is to develop professional development and in-service workshops to prepare in-service and pre-service agriculture teachers in renewable energies. Several methods of professional development have been discussed, including using a mobile renewable energy laboratory built by the BAE department. This would allow teachers to use actual instruments and technologies of renewable energy in a hands-on, experiential way. This particular method of professional development would increase the likelihood of agricultural educators teaching students about renewable energies resonating with agriculture through experiential approaches. In addition, the AECL department will bring together industry experts from across the state to discuss what knowledge and/or skills secondary agriculture students should possess regarding renewable energy technology, with the goal of helping students achieve entry-level employment as well as preparation for higher education (Roberts & Ball, 2009).

Costs/Resources Needed

The costs and resources required for integration of renewable fuels curriculum are divided into costs incurred for Phase I of the project and projected costs for the remaining phases.

Phase I – Creation of the Biofuels Resource Grid

<u>Resources</u>	<u>Costs</u>
Two .25 FTE Ph.D. Graduate Assistants	\$15,000
Total	\$15,000

Phase II – Expansion of the Resource Grid, creation of a robust “clearinghouse” website and alignment of resources to [STATE] Standards

<u>Resources</u>	<u>Costs</u>
Two .25 FTE Ph.D. Graduate Assistants	\$15,000
Total	\$15,000

Phase III – Industry Expert Focus Group and agriculture teacher professional development

Resources

Two .25 FTE Ph.D. Graduate Assistants	\$15,000
Travel/Lodging expenses for 10 experts	\$15,000
Professional Development for 20 teachers	\$20,000
Total	\$50,000

References

Blanton, L. H., Robinson, J. S., Edwards, C. E., & Huhnke, R.L. (2010, February). *The need for alternative fuels and bioenergy in the 21st century: Implications for secondary agricultural education curriculum integration*. Poster presented at the 2010 Southern Region American Association for Agricultural Education Research Conference, Orlando, FL. Abstract retrieved from http://www.aaaeonline.org/uploads/allconferences/2-5-2010_130_Final_Proceedings.pdf

Dillman, H. (2007). *Alternative energy center final scientific/technical report* (DE-FC36-04GO14218). Lansing, MI: Lansing Community College.

President’s Council of Advisors on Science and Technology, (2010). Prepare and inspire: K-12 science, technology, engineering, and math (STEM) education for America’s future. Retrieved from <http://www.whitehouse.gov/sites/default/files/microsites/ostp/pcast-stemed-report.pdf>

Roberts, T. G., & Ball, A. L. (2009). Secondary agricultural science as a content and context for teaching. *Journal of Agricultural Education*, 50(1), 81–89. doi: 10.5032/jae.2009.01081

Sissine, F. (2007). Energy independence and security act of 2007: A summary of major provisions. *CRSS Report for Congress*. Retrieved from: http://energy.senate.gov/public/_files/RL342941.pdf

**Differentiated Instruction for the Learning Disabled in the Ag Science Classroom:
Agricultural Science Teachers' Professional Development**

Michelle Pavelock
Agricultural Science Teacher
PO Box 682
Anderson, Texas 77830
936-349-5229
mpavelock@ascisd.net

Theresa Pesi Murphrey
Assistant Professor
Department of Agricultural Leadership, Education, and Communications
Texas A&M University
College Station, Texas 77843-2116
t-murphrey@tamu.edu
Phone: 979-458-2749
AAAE Member

Differentiated Instruction for the Learning Disabled in the Ag Science Classroom: Agricultural Science Teachers' Professional Development

Introduction

Differentiated Instruction for the Learning Disabled in the Ag Science Classroom: Agricultural Science Teachers' Professional Development is the basis for a workshop designed to help agricultural science teachers develop effective lessons for teaching the learning disabled in a classroom that also accommodates learners from all levels. The need for this type of professional development is very high, as agricultural science classes often include special needs learners.

According to a 2007 study, preservice agricultural science teachers and their teacher educators agreed that training was provided regarding learning disabled students, but that the most commonly used modification/accommodation was cooperative group learning and extended time (Falkner, 2007). A 2009 study also found that student teachers were knowledgeable about Individualized Education Plans (IEPs) and general definitions, but they were not prepared to meet the challenges of accommodating special needs students in agricultural education classrooms and laboratories (Kessell, Wingenbach, & Lawver, 2009).

Differentiated instruction is a method of instruction designed “to recognize students’ varying background knowledge, readiness, language, preferences in learning and interests; and to react responsively. Differentiated instruction is a process to teaching and learning for students of differing abilities in the same class. The intent of differentiating instruction is to maximize each student’s growth and individual success by meeting each student where he or she is and assisting in the learning process,” (Hall, Strangman, & Meyer, 2003, Definition section, para. 1).

A separate study found that agricultural science teachers are using recognized practices in their classes, though they are more likely to use practices that impact students “as a whole or are easy to use rather than individualized strategies for students with special needs” (Stair, 2009). This research also showed that teachers feel they are able to provide quality instruction to learning disabled students; however, they generally disagreed that their teacher training program prepared them to work with students with learning and emotional disabilities (Stair, 2009).

How It Works

The professional development workshop is designed to give agricultural science teachers hands-on training on how to differentiate curriculum in their classrooms. Differentiated instruction, as previously defined, is a method of taking one lesson and forming several “mini-lessons” that include both accommodations and modifications for a variety of learning abilities in the same classroom.

During the workshop, each agricultural science teacher is given the identical lesson to work with. The teachers are then provided the following information: They will have a class that consists of two students who are gifted and talented, 10 general education students of average learning levels, and three special education students. They will also be given three IEPs, and a set of class objectives that must be covered.

The workshop proceeds to walk the teachers through the process of developing a lesson that meets the needs of all learners by using differentiated instruction. Strategies presented in the

workshop include how to choose and employ accommodations and modifications, cooperative learning strategies, and other enrichment activities. During the workshop, teachers are asked to choose which accommodations and modifications they need based on the IEPs provided. They also are provided a listing of ways to involve all learners, what expectations to have for each learner, and how to assess these learners both individually and as a group within the same lesson.

Implications

The implications of this workshop are broad because it assists agricultural science teachers in dealing with the varying learning styles and abilities in their classrooms. Given that the curriculum is hands-on and often deals with safety issues, understanding the extent to which special education students should be involved is critical. This workshop focuses solely on differentiating for the benefit of providing the highest quality education for the learning disabled to help secure future employment based on their experiences in the agricultural science classroom (Moffitt, 2004).

The focus on the learning disabled in the agricultural science classroom is very important because special education students are “noticeably different in terms of their academic ability in relation to their peers” (Moffitt, 2004). They require more planning and more transition services in order to have a productive life after high school (Moffitt, 2004). “It is our learning disabled students who could possibly benefit most from the things agricultural education has to offer. Career and technical education has the potential to give students concrete skills that they can use in the job market and hopefully have an equal opportunity at employment” (Moffitt, 2004).

Future Plans

The concept of providing differentiated instruction is a critical need across the agricultural science curriculum. It is suggested that a series of workshops be developed that would address the areas of differentiating in the agricultural mechanics shop, differentiating in the greenhouse, and differentiating in the animal science lab. Each of these areas are high need areas with safety implications. Expectations and assessments must be adjusted for each individual student’s learning abilities. Differentiation allows all learners to be engaged in the instructional process and gain from the experiences provided. Future plans also include the use of multimedia to provide examples of learners with disabilities engaging in agricultural science activities as a means of introduction to the topic during the workshop.

Costs/Resources Needed

Costs associated with this innovative idea are minimal. The workshop is designed to be a face-to-face session that requires a meeting room and copies of handouts. Travel expense may be incurred depending on the participants’ location.

References

Falkner, P. (2007). *Preparing future secondary agriculture teachers to work with students with learning disabilities*. University Park, PA: The Pennsylvania State University.

- Hall, T., Strangman, N., & Meyer, A. (2003). *Differentiated instruction and implications for UDL implementation*. Wakefield, MA: National Center on Accessing the General Curriculum. Retrieved from http://www.cast.org/publications/ncac/ncac_diffinstructudl.html
- Kessler, J., Wingenbach, G., & Lawver, D. (2009). [Relationships between special education confidence, knowledge, and selected demographics for agricultural education student teachers](#). *The Journal of Agricultural Education*, 50(2), 52-61. doi: 10.5032/jae.2009.02052
- Moffitt, J. (2004). Agricultural education...eoe? *The Agricultural Education Magazine*, 77(1), 12-14.
- Stair, K. (2009). *Identifying confidence levels and instructional strategies of high school agriculture education teachers when working with students with special needs*. (Doctoral dissertation, North Carolina State University). Retrieved from Dissertations & Theses: Full Text.(Publication No. AAT 3357838).

Evaluation Results of Pet Awareness With Children Animal Bite Prevention Program

Authors:

Joel D. Ray, DVM
Michael E Newman, PhD

P.O. Box 6100
Mississippi State, MS 39762

(662)325-3432 - Ray
(662)325-3462 - Newman

Email:

joray@cvm.msstate.edu
MNewman@humansci.msstate.edu

Evaluation Results of Pet Awareness With Children Animal Bite Prevention Program

Introduction

Pet Awareness with Students or P.A.W.S. began as a pilot project to educate elementary aged children about public health concerns. It has grown into a student led program that may be incorporated into the curriculum of the Community Veterinary Service at [University] College of Veterinary Medicine. This lesson about animal bite prevention targeted first and second graders and addresses the public health problem of animal bites.

According to the American Veterinary Medical Association, dogs bite approximately 4.7 million people every year (AVMA Task Force on Canine Aggression and Human-Canine Interactions, 2001). Of those, 800,000 require medical intervention (Overall & Love, 2001). Many studies agreed that children were more prone to animal related bites than adults were (Chun, Berkelhamer, & Herold, 1982) (Overall & Love, 2001). According to Mathews and Lattal, between 60-70% of animal bites in their study involved children (Mathews & Lattal, 1994). It was felt that children may not be attentive to the behavioral signs exhibited by animals before aggressive behavior takes place, or may be unaware that some animals exhibit aggressive tendencies. Other factors related to bite incidents with children involve misinterpreting sounds and actions by children and animals (Overall & Love, 2001) (BSAVA Congress, 2005).

Many bite incidents are preventable with proper training (Bradley, 2007). The ability to detect aggressive cues from animals is a teachable skill. Domestic, as well as wild animals, typically demonstrate behavioral signs indicative of aggression. Facial features of the eyes, ears, mouth are visual indicators of attitude as well as position of the hairs of the coat and posture of the tail. Proper recognition of these behaviors can enable children and adults to prevent injury from animal bites. Knowledge of animal behavior such as curiosity, chasing and mouthing can also aid in prevention of bite wounds. Recalling phrases such as “Be a Tree”, and “Be a Rock” may prevent serious injury when a child is approached or knocked down by a strange dog.

Objectives/Rationale

It is the objective of this project to develop an educational program for first and second grade children that utilizes innovative technologies and interaction to teach children about reading animal behavior. This knowledge may lead to the reduced incidence of animal bites thereby prevent diseases associated with those bites.

Methodology

During the 2009-2010 school year, the program was presented to a local public elementary school. Bite prevention, animal behavior, and zoonotic disease relative to animal bite topics was presented to second grade classes, followed by first grade classes and reached two classes approximating 25 students per week.

Two data collection methods were utilized. The second grade participants documented responses on a paper form. Classroom Audience Response™ devices, incorporated into a PowerPoint™ program, were utilized to deliver and collect the response data for the first grade participants. The PowerPoint™ program to follow, discussed vital information about the topic. At the conclusion of the presentation, the same nine questions were reposed. The before and after data was recorded and compared.

Results to date/implications

We were able to determine children knew very little about animal bite prevention. Based upon the improved scores of each grade, it was felt that they have the capacity, given the proper curriculum, to grasp the information provided. No statistical difference between the scores of first and second grade children exists. In fact, scores of the first graders were higher than the second grade. Because of this, the first and second grade appeared to be an appropriate age to teach children about animal related bites. It was also concluded that, although beneficial in the engagement, the clicker system did not statistically enhance the outcome scores of the participants. We also received very positive informal remarks from teachers and CVM stakeholders indicating stakeholder satisfaction. The end of the semester post evaluation provided valuable information related to long-term retention of the participants. The teacher survey provided valuable information relative to improvements needed for greater effectiveness.

Future plans/advice to others

Based upon this evaluation, several recommendations for improvement were made. Although the use of the Audience Response created technical difficulties and made no statistical difference compared to a paper collection system, this means of engaging participants and accurately collecting valuable data make it worthy of making it a permanent part of the program. The utilization of the ARS greatly increased the presentation time.

Based upon the questions missed most frequently, considerations should be made to separate the current program into separate programs. Scores related to animal bite and reading animal behavior were higher than those related to rabies were. Since this program proved beneficial to first and second graders, it is recommended that the program be amended to determine its effectiveness for kindergartners. Animal bite prevention separated from the current program could be modified for use with that age group.

Reinforcement activities during the presentation may provide a substantive participatory means of learning as well as increase attention span. An activity book, coloring book and bookmarks promoting bite prevention created during the semester should be distributed to the participants as a reward for completing the final posttest.

For stronger epidemiological support, post quizzes repeated a year later would assess the retention level of the children. A repeat quiz held in one year would better evaluate the long-term memory developed after the presentation.

Costs/resources needed

Equipment utilized for this intervention included laptop computer equipped with Powerpoint™, Mechanical dog, and the Audience Response system. Our costs were negligible as much of the equipment was available through the P.A.W.S. program or through interdepartmental borrowing. Coloring books, activity books and bookmarks reinforcing the program are available through [University] Extension Service.

References

- AVMA Task Force on Canine Aggression and Human-Canine Interactions. (2001). A community approach to dog bite prevention. *Journal of the American Veterinary Medical Association* , 1732-1749.
- Bradley, J. (2007, December 7). *Animals and Society Institute*. Retrieved July 7, 2010, from Dog bites: problems and solutions policy paper: <http://www.animalsandsociety.org/>
- BSAVA Congress. (2005). Preventing dog bites with the help of the blue dog. *The Veterinary Record* , 499.
- Chun, Y.-T., Berkelhamer, J. E., & Herold, T. E. (1982). Dog bites in children less than 4 years old. *Pediatrics* , 119-120.
- Mathews, J. R., & Lattal, K. A. (1994). A behavioral analysis of dog bites to children. *Developmental and Behavioral Pediatrics* , 44-52.
- Overall, K. L., & Love, M. (2001, June 15). Dog bites to humans-demography, epidemiology, injury, and risk. *Journal of the American Veterinary Medical Association* , pp. 1923-1934.
- William R. Penuel, Christy Kim Boscardin, Katherine Masyn, Valerie M. Crawford. (2007). Teaching with student response systems in elementary and secondary education settings: A survey study. *Education Tech Research Dev* , 55, 315-346.
- Wilson, F., Dwyer, F., & Bennett, P. (2003). Prevention of dog bites: evaluation of a brief educational intervention program for preschool children. *Journal of Community Psychology* , 75-86.

Giving a Face to Your Agricultural Leadership Program

Avery Culbertson
3127 McCarty Hall B, PO Box 110540
Gainesville, FL 32611
(352) 392-1663
averyculbertson@ufl.edu
University of Florida

Micah Scanga
3127 McCarty Hall B, PO Box 110540
Gainesville, FL 32611
(352) 392-1663
scanga@ufl.edu
University of Florida

Dr. Hannah Carter
G037 McCarty Hall D, PO Box 110126
Gainesville, FL 32611
(352) 392-1038
hscarter@ufl.edu
University of Florida

Giving a Face to Your Agricultural Leadership Program

Introduction/Need for Idea

Welcome to Facebook. According to Facebook Statistics (2010), the social networking site is meeting place for over 500 million users. DiMicco et al. (2008) noted employees in an organization will reach out and network with new people utilizing social networking mediums, expanding the communication potential in organizations to reach out to a greater audience. As Facebook has diffused into organizations as a medium of communication, it has been shown to expand the social capital of a group by strengthening the network of connections between its members. As individuals and organizations attempt to stay connected, Facebook holds potential for everyone, including agricultural leadership programs to build social capital.

In the 1960's, the Kellogg Foundation recognized the continuing need for effective rural and agricultural leadership and in conjunction with Michigan State University, established the Kellogg Farmers Study Program. From this program, multiple state programs have originated. These programs, though different in some aspects (rural vs. agriculture-based) are congruent with the goal of establishing effective leadership for the agricultural industry. According to Lindquist (2010), there are 39 active programs within the United States, Canada, Scotland, Australia and New Zealand.

Traditionally, directors of these agricultural leadership programs have relied on mail, list serves, and email for correspondence. In the world of social networking, Facebook now offers a new medium of communication for these programs as it has with similarly structured organizations. In particular, directors and staff of agricultural leadership programs have the opportunity to utilize Facebook in communicating with stakeholders, current classes, and alumni. Program directors also possess a need to advertise their programs to the public, potential supporters and possible class candidates which can be fulfilled by using Facebook as a viable leadership tool. By programs building their own social capital through individual participant networks, they develop leadership for the industry by increasing social ties.

The theory of Social Capital is defined as “the resources available to people through their social interactions” (Valenzuela et al., p 877). Individuals with large networks are seen as having more social capital than those working in smaller networks. Those involved in networks are able to draw from other members for either information seeking or obtaining resources.

Anecdotal evidence of Facebook usage has shown agricultural leadership programs communicate with their stakeholders through the site. However, very few use it on a regular basis since there is very little knowledge about how to use it or what group members and fans would see as useful. This innovative idea describes the benefits through the use of a Facebook module, may be incorporated within agricultural leadership programs.

How it Works

The module is designed to guide directors in creation or adaption of Facebook utilization for their programs. This innovative idea provides guidance in how to use Facebook in accordance to social capital theory.

This module will take learners through:

1. Basic Facebook operational knowledge to develop skills in setting up and maintaining a Facebook group and fan page.
2. Recommendations to directors in how to facilitate the adoption of a fan page.
3. Recommendations to directors in how to facilitate the adoption of a group.
4. Creation of umbrella group for all participants to connect to other agricultural leadership program graduates.

Giving a Face to Your Agricultural Leadership Program

Results to Date

Information on how Facebook was being used by agricultural leadership programs was collected through informal interviews. Many of the programs were unsure as to how to utilize the page, be it a fan page or a group, to benefit their programs. Several of the program directors or program participants have built Facebook pages, but feel unclear to how to facilitate their operation. Some programs use Facebook for personal interaction such as discussion, pictures, or individual information.

Under the assumption this evidence accurate and valid, results according to the directors, of utilizing the social media tool Facebook have had the following benefits: stronger communication with stakeholders, increased visibility, promoted educational traveling experiences, promoting fundraising events, centralized communications, establishing program brand recognition, increased class communications, and increased alumni communications.

Advice to others

A recommendation in creating and using a site for the program is assessing the technical knowledge of the stakeholders associated with the program. If need be, facilitating a training to develop basic Facebook operational knowledge for administrators. The program director also should decide how the program is going to post information on a fan page or a group forum, if participants of the program have a clear understanding of how Facebook will be used in their program; they are more likely to participate.

Furthermore, Agricultural Leadership Programs can establish a professional image, by creating a fan page. Creating a fan page publicizes the program to the public, allows a fan to promote program events, centralizes communications, establishes brand recognition, creates transparency to the public of program events, lists news releases, and provides industry news.

Creating a group for current classes allows participants of the class to discuss asynchronously class topics, issues, and insights into industry. Furthermore, a group may allow increased social capital through stronger internal network ties. Groups may be closed to the public and members allowing for more intimate and confidential conversations.

It would also be beneficial for the International Association of Programs for Agricultural Leadership to create a larger group site where all alumni members from multiple state programs can connect. The group can be used for networking, discussion of program experiences, issue awareness and dialogue, promoting national meetings, and invitations to events.

Costs/Resources

Administrators would need to possess, or be willing to dedicate the time to possess technical knowledge of Facebook creation and maintenance. Administrators would also need to possess a network of individuals on whom to draw information to post. Facebook utilization would also need to have a buy-in from participants and a “fanbase” in order to receive a return on investment.

References

DiMicco et al. (2008). Motivations for social networking at work. Paper presented at ACM conference on computer supported cooperative work, San Diego, CA. Retrieved from <http://portal.acm.org/citation.cfm?id=1460674>

Facebook Statistics. (2010). Facebook press room statistics. Retrieved from <http://www.facebook.com/press/info.php?statistics>

Lindquist, J. (2010) Kansas agriculture and rural leadership program. Retrieved from www.iapal.net

Valenzuela, S., Park, N., Kee, K.F. (2009). Is there social capital in a social network site?: Facebook use and college students life satisfaction, trust, and participation. *Journal of Computer-Mediated Communication*, 14, 875-901. doi: 10.1111/j.1083-6101.2009.10474.x

INCORPORATING PREPARATORY EXAMS INTO A DUAL CREDIT COURSE
CURRICULUM: PREPARING STUDENTS FOR COMPUTERIZED COLLEGE TESTING
AND INCREASING POST SECONDARY CREDIT SUCCESS RATES

Alanna L. Neely, Cliff Ricketts, and Warren Gill
Middle Tennessee State University

PO Box 5
Middle Tennessee State University
Murfreesboro, TN. 37130
615-898-2523
alneely@mtsu.edu or srickett@mtsu.edu

INCORPORATING PREPARATORY EXAMS INTO A DUAL CREDIT COURSE CURRICULUM: PREPARING STUDENTS FOR COMPUTERIZED COLLEGE TESTING AND INCREASING POST SECONDARY CREDIT SUCCESS RATES

Introduction

Need for Innovation or Idea

Many students are “blind sided” as they leave high school and enter post secondary education. They are unaware of the responsibility and good study habits required in the college setting. Many of these students lose scholarships in the first year due to the required GPA for the particular scholarship. These students could have possibly increased their chances of maintaining these much needed scholarships if they had known what to expect in college. Dual credit and dual enrollment classes can help to alleviate this lack of preparedness for these students.

Research has shown that students who are actively involved in any planned area of interest during high school have a greater chance of success in both post-secondary education and when they reach the workforce, enabling them to have a better chance at high-skill, high wage, and / or high-demand occupations.

With this in mind, the primary focus of this project is to incorporate preparatory exams into the existing curriculum and allow for any eligible student who is enrolled in Greenhouse Management in the Agricultural Education classroom in the specified school system to gain three hours of college credits while still in high school in agricultural education. These students were enrolled in ABAS 1101, Introduction to Ornamental Horticulture in the School of Agribusiness and Agriscience at (University) while simultaneously earning high school credit in Greenhouse Management at the secondary level. This post-secondary course is required in all areas of Agriculture (or can be substituted) at the post-secondary level at (University).

(University), in partnership with thirteen secondary schools won a Perkins IV Reserve Fund Grant to aid in course development, teacher training and oversight of coursework for dual credit. (University) is the first four year institution in Tennessee to provide a dual credit offering with a Career and Technical Education course. These schools worked in cooperation with (University) to develop the necessary competencies to allow for dual credit. We suggest that incorporating preparatory exams into the existing dual credit curriculum will improve not only test scores but college retention rates and performance.

Method

Our Model

In addition to the course curriculum, college success techniques and concepts were introduced to the participating students by the dual credit coordinator. The coordinator visited each of the thirteen schools a minimum of four times. During the visits these concepts were introduced by a hands-on computer activity entitled *What Will I do After High School?*, developed by the dual credit coordinator and a video entitled *Cracking College: The Seven Savvy Secrets of College Students*. Students, through the leadership of the Agricultural Education teacher at the secondary level and the dual-credit coordinator at the post-secondary level, were exposed to the vital strategies and techniques listed below in the results section.

Our goal was to integrate a “coaching” segment into the proposed curriculum to benefit the future success of the student at the post-secondary level. Learning commitment and teaching students’ college responsibility of post-secondary studies early in their development should allow students the much needed assistance to transition and succeed as post-secondary students.

Results

Participation

There were thirteen grant schools and twelve non-grant school participants. Within these schools, 448 students participated and were exposed to the course, the dual credit coordinator and the following college success techniques of:

- Choosing the best courses.
- To Study Smarter, Not Harder
- Succeeding with less stress
- The art of exam preparation
- "Kinetic energy" study techniques
- The ultimate place to study.
- Easier homeworks
- Finding out what is going to be on the exam.
- Getting outstanding letters of recommendation
- "College Friendly" time management
- Ace your finals!
- The easy secret to turning B papers into A papers.
- Finding school sponsored exam repositories.
- How to choose the best professor and course
- How to schedule more free time

Implications

Students will be better prepared for college classes and testing because of the integration of preparatory exams and techniques to improve college success into the dual credit curriculum. More students should transition to a post secondary program and post secondary scholarship and graduation rates may increase at the post secondary level. Students, who might not have considered post secondary before, will get a sense of “I can too”. Success rates will improve and stronger alliances will be built between university and high school faculty.

Future Plans

Current

(University) is currently offering a second and third dual credit course, Agribusiness Finance/ABAS 1201 and Leadership/1301. The dual credit course coordinator visits and will continue to visit each participating school to introduce these college success techniques which include active study techniques which improve test scores. We plan to conduct a research study on the effectiveness of these suggested college success techniques in the near future.

Advice

This is a great opportunity for not only the university but most importantly the student. The key to the success of this is to be sure all stakeholders are involved at all times. This would include: university faculty, high school teachers, principals and school counselors. We found that when everyone is involved the courses run smoothly.

Resources

The initial grant provided each school with the necessary resources to offer the course. However, most schools have these resources in place. (University) provides the dual credit course coordinator and is available to visit each school upon request.

References

- College Crossroads. (Producer). (2007). *Cracking college 7 secrets of savvy students* [DVD]. Available from <http://www.crackingcollege.com>
- Hoffman, N., Vargas, J., & Santos, J. (2009). New directions for dual enrollment: Creating stronger pathways from high school through college. *New Directions for Community Colleges*, 16, 143-158.
- Karp, M., & Hughes, K. (2008). Study: Dual enrollment can benefit a broad range of students. *Techniques: Connecting Education and Careers*, 20, 14-17.
- Smith, A.R., & Garton, B.L. (2008). Prior college credit of first semester freshman: does it make Difference? *NACTA*, 352(3), 39.

Incorporating Socioscientific Issues into Agriculture Teacher Education Curriculum

Adrienne N. Gentry
P.O. Box 110540
Gainesville, FL 32601
(352) 392-0505 Ext. 244
agentry@ufl.edu

Catherine W. Shoulders
P.O. Box 110540
Gainesville, FL 32601
(352) 392-0502 Ext. 238
katewoggs@ufl.edu

Brian E. Myers
P.O. Box 110540
Gainesville, FL 32601
(352) 392-0502 Ext. 236
bmyers@ufl.edu

Incorporating Socioscientific Issues into Agriculture Teacher Education Curriculum

Introduction/Need for Innovation

In recent years, several organizations have recognized the need for an increase in the number of scientifically literate graduates prepared to enter the agricultural and natural resources workforce (USDA, 2005; APLU, 2009). Scientific literacy involves engaging in scientific practices such as generating questions, reasoning logically, using evidence to support claims and utilizing these scientific practices in personal and social contexts, termed socio-scientific issues (SSI) (Sadler, 2009). SSI-based instruction challenges the assumed links between understanding school science and a student's ability to apply science in personal and social contexts. Topics that are deemed SSIs generally demonstrate a distinctive amount of social interest, outcome, and consequence (Sadler, 2003).

Many SSIs, such as water quality and conservation, animal welfare, and genetically-modified foods, have direct ties to the secondary agriculture curriculum. In order for secondary agriculture teachers to enhance their students' scientific literacy by including SSI-based instruction, teacher education programs should work to expose preservice teachers to the use of SSIs as a curriculum model (Zeidler, Walker, Ackett, & Simmons, 2002). [University] has incorporated the use of SSI-based curricula in secondary agriculture classes into the teacher preparation program in an effort to better prepare agriculture teachers to facilitate the learning of scientific concepts and increase the number of scientifically literate agriculture students.

How it Works

SSI instruction is not simply a one day lesson; it is a teaching framework. One large-scope, societal issue is posed to students, who are encouraged to make informed opinions and suggestions regarding the issue and its solution. Through the student inquiry generated by this task, scientific and agricultural concepts are taught within the framework of the socioscientific issue. Lessons are designed to guide student inquiry related to developing solutions and opinions regarding the SSI. This curricular framework allows students to engage in scientific discourse while developing an understanding of scientific and agricultural concepts. Throughout the process of developing a working understanding of the content and processes related to the socioscientific issue, discussion of moral, economic, and ethical dilemmas that make these issues so controversial can occur. As students form opinions and make decisions related to the issue, they are expected to justify their stances with scientific evidence. While following a student-centered line of inquiry, this teaching approach is different than inquiry based instruction or problem-solving methods because SSIs require that students take moral reasoning, ethical, and economic concerns into consideration (Walker & Zeidler, 2007) where traditionally, these aspects were left out of inquiry based instruction. However, because of the extremely social nature of these issues, it is essential that these important aspects are readily incorporated into lessons.

Results to Date/Implications

Two Units of Reusable Learning Objects (RLOs) have been created for the purpose of introducing preservice agriculture teachers to SSI-based curriculum designs. One is titled, “Socioscientific Issues” and the other is titled, “SSIs and Agricultural Education”. “Socioscientific Issues” is an overview of what SSIs are, characteristics of applicable SSIs, examples of lessons that can be taught through SSIs, student benefits of learning through SSIs, and advice to instructors utilizing SSIs. “SSIs and Agricultural Education” provides a framework for how SSI based instruction can be used in a secondary agricultural education class, as well as a sample lesson framework for a unit of SSI based instruction. These RLOs are included in the spring semester curriculum for the preservice agriculture teachers as well as in the curriculum for students enrolled in the online Masters of Agricultural Education Cohort, all of whom are employed agriculture teachers or extension agents. Other agricultural teacher education programs can use the created RLOs to implement SSI based instruction into their curriculum.

Future Plans/Advice to Others

Plans have been made to expand the curriculum to include more detailed examples of lesson formats and curriculum guides because of the numerous SSIs that directly relate to agricultural education. Additionally, to stay up-to-date on the most recent SSIs, continued development of SSI curriculum will be ongoing.

University faculty should understand where in the teacher education curriculum the utilization of SSIs should be introduced. Agricultural education preservice teachers should understand that SSIs are controversial in nature and should be approached with an open mind, and require extensive knowledge about the issues, skillful facilitation of instruction, familiarity with the logic necessary for critical thinking, and the ability to disguise personal bias. As long as proper facilitation of student learning transpires and there are ground rules by which students agree to abide, meaningful discussions that interest and engage students can occur. University faculty should also develop their own materials to match local current issues, as some SSIs are more applicable in certain areas than others.

Costs/Resources Needed

Time was a factor in creating the RLOs and developing the curriculum. Additionally, technology that allowed for narration of the RLOs was necessary to maximize RLO utility for students taking online classes. Universities must have a way to access the RLOs created by [University]. The RLOs are currently available through an internet-based online learning center. University faculty should also have knowledge of SSIs and stay current on issues that would qualify as SSIs.

References

- Association of Public and Land-grant Universities (2009). *Human Capacity Development: The Road to Global Competitiveness and Leadership in Food, Agriculture, Natural Resources, and Related Sciences (FANRRS)*. Washington, DC: Association of Public and Land-grant Universities.
- Latourelle, S.M., Poplawsky, A., Shmaefsky, B., & Musante, S. (2010, September 02). *Using Socioscientific issues-based instruction*. Retrieved from <http://serc.carleton.edu/sp/library/issues/>
- Sadler, T.D. (2003). Informal reasoning regarding socioscientific issues: a critical review of research. *Journal of Research in Science Teaching*, 41(5), 513-536
- Sadler, T.D. (2009). Situated learning in science education: socio-scientific issues as context for practice. *Studies in Science Education*, 45(1), 1-42.
- U.S. Department of Agriculture Cooperative Research, Education, and Extension Service & Perdue University. (2005). *Employment Opportunities for College Graduates in the U.S. Food, Agricultural, and Natural Resources System (2004-38837-01875)*. West Lafayette, IN: Perdue University.
- Walker, K.A., & Zeidler, D.L. (2007). Promoting discourse about socioscientific issues through scaffolded inquiry. *International Journal of Science Education*, 29(11), 1387–1410.
- Zeidler, D.L., Walker, K.A., Ackett, W.A., & Simmons, M.L. (2002). Tangled up in views: Beliefs in the nature of science and responses to socioscientific dilemmas. *Science Education*, 86, 343–367.

**Integrating 21st Century Technology in Secondary Agricultural Education Classrooms:
GPS Professional Development Carousel Workshop**

J. Shane Robinson

457 Ag Hall

Stillwater, OK 74078

(405) 744-2972

shane.robinson@okstate.edu

Jon W. Ramsey

455 Ag Hall

Stillwater, OK 74078-6032

405-744-3094

jon.ramsey@okstate.edu

Integrating 21st Century Technology in Secondary Agricultural Education Classrooms: GPS Professional Development Carousel Workshop

Introduction/Need for Innovation

The teacher is the single most important variable in school effectiveness (Goodlad, 1983). Teachers develop and improve their skills, pedagogically and technically, through high quality professional development (PD) programs (Anderson, Barrick & Hughes, 1992). As such, high quality PD programs are vital. Each year, the faculty at [State] University is asked by the [State] Department of Career and Technical Education to assist with the development and delivery of in-service, PD workshops. The integration of Global Positioning Satellite (GPS) technology into the agricultural education classroom was the focus of this PD program.

The format of the two-day PD program replicated *The Amazing Race!* by using a carousel of activities that relied on GPS data points. The major theme for the carousel activities relied on elements of science, technology, engineering and mathematics (STEM). Specifically, four “carousels” were developed with *The Amazing Race!* theme. The four carousel themes consisted of “How windy are you?,” “Landscape to Replicate,” “Bugged Out,” and “Drink if you Dare.” Each theme consisted of a case study regarding aspects of STEM in the context of agriculture. Example carousel, case study activities included testing water quality, calculating the area of a landscape, using identification keys to determine insect nomenclature, and designing wind turbine blades to power a series of low voltage lights. Each activity was positioned at various locations on the [State] University campus. Participants used handheld GPS devices to locate each station included in the carousel. To simulate the spirit of *The Amazing Race!*, contestants were timed as they progressed through each station and rewarded for completion of each activity.

The PD program emphasized GPS technology because it is an excellent, multidisciplinary, inquiry-driven, field-based, standards-based tool applicable to many subjects, including mathematics, geography, earth science, and environmental studies (U.S. Department of the Interior, 2009). To encourage participants to apply their PD experiences in their classrooms, teachers were taught how to locate data points using GPS and then were provided time to develop lessons plans that utilized the technology.

How it Works

Day one of the PD consisted of the introduction of the GPS unit. Each teacher was provided a GPS unit as a reward for attending the workshop. A demonstration occurred in which teachers practiced using their unit to locate various data points. Then, once teachers were confident in their abilities to use the units effectively, an explanation of *The Amazing Race!* GPS carousel activities ensued. Specifically, teachers were informed that they would be formed into groups. Each group would use their GPS unit to locate data points on campus at [State] University. Once they located their data point successfully, there would be a person assigned to that location who would read off a challenge (i.e., carousel case study) for the group to solve. Numerous resources existed at each station that could be used to solve the challenge. Their charge was to work together to complete the four activities expeditiously and accurately. A different order of GPS data were assigned to the groups (leading to a different order of completing the carousel activities) to prevent having multiple teams arrive at the same locations at the same time.

Day two consisted of reflection and metacognition. Specifically, teachers were encouraged to think about their activities deeply and determine ways in which they could integrate the activities and technology into their secondary programs. Time was allotted for lesson planning. Laptop computers were set up and an electronic version of the [State] University lesson plan template was uploaded onto the computers to enable teachers to develop lessons integrating the activities and technology into their existing curricula systematically. Then, once lesson plans had been written, teachers were “shown” where they had been the day before by way of the GoogleEarth tracking system. Lastly, teachers were allowed to “test out” their results based on the activity, “How Windy are You?” to determine which team produced the most amount of wind output.

Results to Date

The GPS carousel workshop occurred June 10-11, 2010 at [State] University. Eight teachers attended the workshop and were split into two groups of four. Group one appeared to be more constructivist in their attempt at solving the problems of the case studies. Specifically, they completed each activity faster than their counterparts in group two. Individuals in group one possessed strong teamwork and communication skills. They split up duties evenly to accomplish the task at hand. Comparatively, group two appeared to be more behavioral in nature. This group took longer to complete their respective activities. These individuals read the directions step-by-step and discussed how they would attack the problem systematically. As such, they were extremely methodical and sequential with solving the problems within the case studies.

Interestingly, on day two, the “behavioral group’s” (group two’s) wind turbine produced the most amount of power. This finding allowed the instructors to discuss with the teachers the importance of using both behavioral and constructive approaches in the classroom. During this activity, the “constructivists” were more expedient in finishing *The Amazing Race!*. However, the “behaviorists” achieved the most complete data and output in solving the problems.

Future Plans

Due to the positive comments from the teacher participants and general “success” of this workshop, the faculty at [State] University plan to offer another round of carousels next June with the intent of serving a wider group of teachers. To improve attendance, the instructors will advertise the workshop earlier on the [State] teachers’ list serv. Further, the carousels will be updated and improved so that the content remains fresh and new.

Resources Needed

Three faculty and two Ph.D. graduate students were used to facilitate the four carousels (i.e., PD stations). The goal is to have 20 teachers participate in the GPS carousel workshop in June 2011. Costs associated with hosting the PD are listed below.

Resource	Cost
Three agricultural education faculty instructors	- - -
Two agricultural education Ph.D. students (\$250.00 ea.)	\$500.00
Etrex Garmin GPS units (\$150.00 X 20)	\$3,000.00
Three-ring advanced organizer binders (\$7.69 X 20)	\$153.80
Printing costs (\$0.15 per copy X 20 participants)	\$3.00
Total	\$3,656.80

References

- Anderson, T. J., Barick, R. K., & Hughes, M. (1992). Responsibilities of teacher education for vocational teacher professional development programs. *Journal of Agricultural Education*, 33(2), 43–50. doi: 10.5032/jae.1992.02043
- Goodlad, J. (1983). *A place called school*. New York, NY: McGraw-Hill.
- U.S. Department of the Interior, U.S. Geological Survey, (2009). *GPS in education*. Retrieved from http://education.usgs.gov/common/lessons/gps_in_education.html

Integrating Service-Learning into International Study Abroad Programs: Easy as PIE

Joelle Petrosky
Graduate Assistant
Texas A & M University
131 Scoates Hall
College Station, TX 77843-2116
979-862-7650
jpetrosky@aged.tamu.edu

Jennifer Williams
Assistant Professor
Texas A&M University
119 Scoates Hall
College Station, TX 77843-2116
979-862-1423
dr.jen@tamu.edu

Integrating Service-Learning into International Study Abroad Programs: Easy as PIE

Introduction

In *My Freshman Year: What a Professor Learned by Becoming a College Student*, an undercover professor posed as a freshman at a state university. From her investigation she discovered, “the single biggest complaint international students lodged against U.S. students was...our ignorance [or] the misinformation and lack of information that Americans have both about other countries and about themselves” (Nathan, 2005). Ethnocentrism is not a new concept, but advancements in technology and communications have created a global society where students will need to move past this phenomenon.

Caligiuri and Tarique (2009) note “the global environment has not only changed the way business is conducted, it has also changed the criteria of effectiveness for the firms’ leaders in the way business is conducted” (p. 336). Students in Colleges of Agriculture must be equipped with global leadership skills and rise above ethnocentric mental models. In the 2009 Report of the Task Force on Internationalization of the Curriculum for the College of Agriculture and Life Sciences at (UNIVERSITY NAME), the Dean’s Charge affirmed that globalization should be a priority of the college. A holistic approach to internationalizing curriculum can be found in the partnership between leadership education and agricultural technical sciences to create a service-learning study abroad program for students that can be integrated into existing technical study abroad programs. Educators at (UNIVERSITY NAME) aspire to create globally minded leaders by designing a study abroad program aiding technical science faculty in Colleges of Agriculture in incorporating personal leadership development via service-learning into study abroad programs.

How It Works

Designing a study abroad program with a service-learning aspect is easy as PIE:

1. **Planning-** Planning will include defining selection criteria and interviewing and selecting participants (Tritz & Martin, 1997) as well as selecting a location for the service-learning project. Nancy Wessel (2007) states that finding an international location for students to be useful in a short term visit can be a challenge. Flexibility and collaboration are a must for successful partnerships when planning a service-learning study abroad program. Faculty must gain contacts with community leaders in the area they are conducting the program. Understanding the needs of the community or organization the students will be working with is imperative when you set up a service-learning project. Also, students must be provided with in-depth information regarding cultural preparation and existing cultural perceptions that might hinder the international experience. This cultural preparation could be presented to participants via trip orientation.
2. **Implementation-** Implementation is the actual study abroad and service-learning experience. Learning goals for participants should be clearly stated and expectations for students as well as faculty should be identified for the program. Faculty will help facilitate students moving from ethnocentrism to multiculturalism- a transition from ideas of cultural superiority to a state of comfort and acceptance of other cultures. Multiculturalism is an ongoing process of openness and appreciation of other cultures and is an essential aspect of effective leadership (Komives, Lucas, & McMahan, 2007). For participants to get the most out of their study abroad experience, frequent debriefing must

be incorporated throughout the program. Encourage students to keep a journal to record the personal impact of experiences (Ricketts & Morgan, 2009).

3. **Evaluation-** In the evaluation stage, faculty will help students move beyond reflection (framing the experience and providing a description of what the students observed) to refraction (obtaining purposeful learning outcomes from reflection by assessing how the experience affected students). Refraction is defined by Pagano and Roselle (2009) as the “transformative learning stage where we clarify issues by providing new facts and evidence” (pg. 223). Students are guided beyond reflection to refraction through the critical thinking process. In the critical thinking process students identify the relevance and perspectives of their experience through evaluating their reflection in a systematic and purposeful manner (Pagano & Roselle, 2009).

Implications

Global leaders are best produced through global experiences. Javidan, Teagarden, and Bowen (2010) stress “in a bumpy world, we need leaders who can see past culture and politics to engage people who are wholly unlike themselves” (p. 113). By infusing a service-learning aspect into a traditional, technical study abroad program, students can work on personal leadership development as well as agricultural development. According to Pagano and Roselle (2009) international service learning programs are an excellent avenue for students to develop a new and less ethnocentric mental model of the world. By integrating a service-learning experience into an international experience, faculty can advance the research priority areas of agricultural leadership, agricultural education in domestic and international settings, as well as agricultural education in university and postsecondary settings (Osborn, n.d.). As the emphasis on internationalization increases at the University level, faculty must begin working “smarter, not harder” and partnering with established study abroad programs which give students only technical experiences abroad. A holistic approach will benefit both the student and the international community.

Future Plans

The future plans for this project include procuring funding to train technical science faculty in Colleges of Agriculture on the integration of personal leadership development via service-learning. Evaluation using the refraction principle will also be conducted and analyzed to measure the personal leadership growth of the students. Discussions between the technical leaders and the social sciences leaders of the program will also increase program effectiveness.

Costs/Resources Needed

The largest resource needed is support from the university. Working with the study abroad office as well as finding technical science faculty to partner with would be the most important resource. Securing funding for travel to set up the experience is also a potential cost. The costs of study abroad experiences differ greatly depending on the community selected as well as the longevity of the program.

References

- Caligiuri, P., & Tarique, I. (2009). Predicting effectiveness in global leadership activities. *Journal of World Business*, 44, 336-346.
- College of Agriculture and Life Sciences (COALS), [University]. (2009). *Task force report on internationalization of the curriculum*. Retrieved from <http://agroamaps.tamu.edu/page.asp?o=tamu&s=amp&p=423749>
- Javidan, M., Teagarden, M., & Bowen, D. (2010, April). Making it overseas. *Harvard Business Review*, 109-113.
- Komives, S. R., Lucas, N., & McMahon, T.R. (2007). *Exploring Leadership*. San Francisco, CA: John Wiley & Sons, Inc.
- Nathan, R. (2005). *My freshman year: What a professor learned by becoming a student*. Ithaca, NY: Cornell University.
- Ricketts, K. G., & Morgan, C. (2009). Internationalizing Leadership Development: Important Components within Educational International Leadership Experiences. *Journal of International Agricultural and Extension Education*, (16)2. Retrieved from, http://www.aiaee.org/attachments/065_Ricketts-eVol-16-2-2.pdf
- Osborne, E. W. (Ed.) (n.d.). *National research agenda: Agricultural education and communication, 2007-2010*. Gainesville, FL: University of Florida, Department of Agricultural Education and Communication.
- Pagano, M., & Roselle, L. (2009). Beyond Reflection Through an Academic Lens: Refraction and International Experiential Education. *Frontiers: The Interdisciplinary Journal of Study Abroad*, (18). Retrieved from, <http://www.frontiersjournal.com/documents/FrontiersXVIII-Fall09Pagano-Roselle.pdf>
- Tritz, J. A., & Martin, R. A. (1997). The Collegiate International Experience: Criteria for Successful Experience Abroad Programs. *Journal of International Agricultural and Extension Education*, (4)2. Retrieved from, <http://www.aiaee.org/vol-42-summer-97/386-the-collegiate-international-experience-criteria-for-successful-experience-abroad-programs.html>
- Wessel, Nancy. (2007). Integrating Service Learning Into the Study Abroad Program: U.S. Sociology Students in Mexico, *Journal of Studies in International Education* (11). DOI: 10.1177/1028315305283306

Leveraging Web 2.0 Programs to Increase Academic Retention

Michelle Mullins Santiago,
Michael Lau,
Art Wolfskill,
Maud Roucan-Kane

Sam Houston State University
Box 2088
Huntsville, TX 77341-2088
(936-294-1193)
mmsantiago@shsu.edu

Leveraging Web 2.0 Programs to Increase Academic Retention

Introduction

It is important for educators to understand the changing communication styles among students in today's classroom. The importance of technology is the diffusion of knowledge to increase students' competencies and to expose instructors to different learning delivery systems for their subjects (Tough, 2009). The learning experience of today's students, Millennial or Generation 'Y', must compliment specific information styles associated with the digital age. These students are techno-savvy, visual and digital learners, and are dependent on the use of technology to communicate (Gladden, 2006; Young, 2009).

Myspace, Facebook, Tumbler, Twitter, etc. are popular forms of social networks external from the education environment. The most popular, Facebook, has over 400 million active users and 35 million user updates per day (Facebook, 2010). While many colleges currently use eCollege or Blackboard for teaching and digital communication, very few students use these programs out of class making it difficult to effectively communicate with students in a timely manner. This ineffective message is necessary to appreciate how social media inclusions can benefit education.

Educators have increased social network use in the classroom but concerns over content control, privacy rights, and copy right issues have limited adoption (Ewbank, 2008; Shui, 2007). Even with these limitations, Facebook adoption by educators for teaching purposes is increasing (Kayri, 2010). However, the role of Facebook and other teaching social networking sites in education are still to be determined. Educators are being asked to be more techno-savvy but adoption has been slow (Saunders, 2008). A gray area is developing between professionalism and expectations among of adoption for educators.

Use of online social media networking can assist in knowledge retention and complement traditional teaching methods. With students already accepting technology as a way of life, digital inclusion through virtual learning will be necessary to increase education content outside classroom confinements, which increases students' engagement. This is critical when managing organizations or collective individual groups that are not in regular contact, such as for class.

How it Works

In order to increase student involvement, retention, and to provide visual inclusion in education outcomes, the structured use of web 2.0 programs were implemented in the management process of the university's agribusiness academic competition team (AACT). The voluntary team is comprised of two groups of students, agricultural marketing and agricultural economics quiz bowl. The team members received neither academic credit nor monetary compensation for their time. The team members traditionally met for one hour, one afternoon every two weeks to brainstorm ideas, divide research, or study academic materials. Over a two month period, face-to-face meetings were suspended, and the web 2.0 leverage was implemented.

At the last face-to-face meeting, team members were surveyed to determine their current level of member-to-member interaction, member-to-advisor interaction, and time spent working on team activities, and their interest in alternative methods of meeting and working together on material for the two competitions. They were also asked about their current usage of web 2.0 programs, in

terms of time spent and purpose of use. Following the survey, team members were asked to register for the following web 2.0 programs: Twitter, Dropbox, Delicious, and Mindmeister. Over the next two months the team met and collaborated through web 2.0 programs, where student responses and submissions were observed. At the end of the two months, the team was again called for a face-to-face meeting and surveyed.

During the two-month web 2.0 period team members were asked to utilize the web 2.0 applications. Both groups of students were asked to follow coaches' Twitter accounts and respond to the "tweets" in a number of ways. The coaches tweeted questions to the two groups every two days and the students were asked to respond to the tweet within another two days. Students chose their response method and responses could range from tweets to research submissions to project manuscript revisions to no response. Number, type, timeliness and quality of responses were recorded from each student.

Results to Date

The purpose of the two-day response time was intended for repetition yet flexibility; to encourage student focus through repetition but allow students adequate time to respond if they were in class, at work, or did not have immediate access to technology. It also provided students time to review the concept for a correct answer if they did not immediately know.

Increased interaction was observed among team members resulting in greater collaboration on research and idea development. Students regularly updated information on Dropbox and Delicious to openly share with other members. This provided up-to-date information and provided ease of access with flexibility. Tweets allowed students to communicate openly in a private forum much like short media messages (SMS) as a group.

Future Plans

Future plans are to implement web 2.0 programs into classrooms and general agribusiness curriculums. The goal is to identify one interactive program to increase the networking capabilities between students and collaboration between students. Twitter and Dropbox were the two most favored programs because of ease of use, timeliness, and applicability for other purposes. Faculty members should not be afraid to adopt these free services to enhance professional and classroom collaboration.

Costs

Direct cost includes internet access for these web 2.0 programs. Students and faculty may use the free internet access provided by the university or they may purchase internet usage on their mobile device (\$20/month) or at home (\$20-\$40 depending on service). Most students currently employ one or both of these direct costs already. While the recommended web 2.0 applications can be purchased (higher service level), students and faculty only used the basic free service.

Indirect cost includes time by both faculty members and students. This time includes learning the application, creating content, sending content, and responding to content. For faculty, it also includes monitoring responses and evaluating students' quality of response.

References

- Ewbank, A., Carter, H. & Foulger, T. (2008). MySpace Dilemmas: Ethical Choices for Teachers using Social Networking. In K. McFerrin et al. (Eds.), Proceedings of Society for Information Technology & Teacher Education International Conference 2008 (pp. 2580-2584). Chesapeake, VA: AACE.
- Gladden, Naomi. (2006. Oct. 12). Generation Y College Students. (Online). November 5, 2010. http://collegeuniversity.suite101.com/article.cfm/generation_y
- Kayri, Murat, and Ozlem Cakir. (2010, Aug.). An Applied Study on Educational Use of Facebook as a Web 2.0 Tool: The Sample Lesson of Computer Networks and Communication. International Journal of Computer Science and Information Technology.” 2 (4), 48-58
- Saunders, S. (2008). The Role of Social Networking Sites in Teacher Education Programs: A Qualitative Exploration. In K. McFerrin et al. (Eds.), Proceedings of Society for Information Technology & Teacher Education International Conference 2008 (pp. 2223-2228). Chesapeake, VA: AACE.
- Shui, H., J. Fong, and J. Lam (2010). Facebook – Education with Social Networking Websites for Teaching and Learning. Lecture Notes in Computer Science, Volume 6248/2010, 59-70, doi: 10.1007/978-3-642-14657-2_7.
- Tough, Megan. (2007. Feb. 25). Why Informal Communication Styles Work. (Online). November 5, 2010. http://www.flyingsolo.com.au/p225536127_Why-informal-communication-styles-work.html
- Young, E. (2009, Nov. 5). Teaching the Facebook Generation. Bloomberg Businessweek. Retrieved from http://www.businessweek.com/bschools/content/nov2009/bs2009115_016982.htm

Maximizing Preservice Teacher Education: The Pre-Internship Block

Catherine W. Shoulders

Eric Rubenstein

Brian E. Myers

PO Box 110540

Gainesville, FL 32611-0540

352-392-0502 x. 238

katewoggs@ufl.edu

erubenstein@ufl.edu

bmyers@ufl.edu

Maximizing Preservice Teacher Education: The Pre-Internship Block

Introduction/Need for Innovation

The continuous flow of research regarding beginning agriculture teachers' professional development needs consistently recommends the alteration of preservice teacher education to reduce needs in reported areas (Garton & Chung, 1996; Mundt & Connors, 1999; Myers, Dyer & Washburn, 2005). In a review of literature detailing the needs of beginning agriculture teachers, Myers, Dyer, & Washburn (2005) found that the greatest needs for education "deal with the classroom instruction component of the complete agricultural education program" (p. 2). While needs can vary greatly between teachers (Myers, Dyer & Washburn, 2005), pre-internship blocks can assist in reducing the number and magnitude of needs of beginning teachers. Reducing these needs can also help to decrease the number of teachers that leave the profession during the early years of their careers (Myers, Dyer & Washburn, 2005). This poster displays the current components and successes of a pre-internship block, an aspect of a teacher education program developed to provide preservice teachers with instructional and curriculum based experiences common to classroom teachers in agricultural contexts.

Components

The pre-internship block is an intense, experiential "boot camp" delivered to preservice teachers in the four weeks immediately before their 12 week internship. Preservice teachers are exposed to specific teaching practices in agricultural contexts, all structured within the typical secondary school-day schedule.

The block consists of sessions conducted by university faculty in various departments, high school teachers, and external affiliates. The past year's sessions regarding technical agriculture in secondary classrooms included managing the agriscience lab, agricultural mechanics skills, agribusiness skills in secondary programs, environmental horticulture, assessing and evaluating labs, veterinary medicine and clinical pathology, woodworking, welding, electricity, agricultural safety, food science, meat science, and beef cattle. Topics are chosen each year based on research regarding beginning teacher needs in technical agriculture, as well as through ongoing discussion regarding particular class needs and the value of sessions in previous years. Sessions are held in facilities both on the university campus in the departments of specialization, as well as in high school facilities.

Preservice teachers are also exposed to sessions regarding other facets of the profession, including meeting requirements of the College of Education, academic and performance standards affecting agricultural education, graduate and doctoral programs, and liability. These sessions are led by university faculty and affiliates from related departments. External speakers, such as a lawyer experienced in educational liability, are also brought in to enhance the specialization and expertise available to preservice teachers during sessions.

One day of the block is devoted to visiting an agriculture experiment station to expose preservice teachers to the current research being conducted in agriculture, provide each preservice teacher with experience operating a number of different farming vehicles, and discuss best practices when taking students on field trips. Preservice teachers leave the experiment station having networked with the staff of a facility that invites student groups to visit, providing them with a potential field trip for their future students.

During the third week of the block, preservice teachers are taken to the state FFA Leadership Training Center (LTC), which serves as an overnight stopping point during visits to several agriculture education departments in area middle and high schools. Preservice teachers

are given tours of department facilities by each agriculture teacher, as well as engage in a question/answer session with the teacher to gain insight in maintaining and improving a successful program. Also during their stay at the LTC, preservice teachers participate in sessions about classroom management, leadership in agriculture, diversity and selection of agriculture facilities, preparing for an agriscience fair, time management, and experiencing internship success, all delivered by university faculty and high school teachers. Lastly, the preservice teachers spend a day working with and judging a district Career Development Event (CDE) in order to get firsthand experience both judging and hosting a district CDE.

Implications/Results to Date

While the block's offerings have varied slightly based on the needs of the students each year, preservice teachers enrolled in the block have consistently reported greater ease in linking concepts taught in technical agriculture courses to the classes they taught during their internships. These increased connections between technical information and instructional strategies allow preservice teachers to deliver well prepared lessons, leading to more successful teaching experiences. The intense time spent together during the four-week block helps preservice teachers establish a sense of community, encouraging them to openly review and share lesson plans and ideas. The preservice teachers also benefit from the time spent with experts in various areas of technical agriculture, and are in turn able to use this new network of specialists as resources in their future careers. Lastly, the time frame of the block gives preservice teachers an opportunity to experience the schedule of an agriculture teacher, as well as learn how to manage the demands between personal and professional life, before their internship begins. These successes suggest the importance in creating a viable and appropriate block prior to preservice teachers beginning their internships.

Advice to Others/Future Plans

In order to improve the utility of the block each year, block sessions and facilitators/leaders are evaluated by agricultural teacher education professionals to ensure proper presentation and implementation of content. It is recommended that teacher educators continue to adapt the pre-internship block by establishing an evaluation process where the sessions, leaders, and students are evaluated to ensure the continuation of an appropriate, effective pre-internship block. Each evaluation should be used in conjunction with established needs of each preservice teacher group to plan and organize each year's pre-internship teacher block. This action allows for better prepared teachers to enter the field once they have graduated from their respective institutions. Each institution is encouraged to adjust session topics to better prepare the preservice teachers based on their needs.

Resources Needed

Resources for each preservice block will vary due to individual preservice teacher needs, as well as the incorporation of information relating directly to the agricultural industries of each state. However, the success of all pre-internship blocks hinges on the collaboration of agricultural teacher educators and industry specialists, including university faculty, business leaders, and agriculture teachers. Relationships with these individuals are crucial in order to provide preservice teachers with the specific facilities and expertise necessary to prepare them for improved teaching experiences. These industry networks hold great impact on the material resources that must be acquired by the teacher educator.

References

Garton, B. L., & Chung, N. (1996). The inservice needs of beginning teachers of agriculture as perceived by beginning teachers, teacher educators, and state supervisors. *Journal of Agricultural Education*, 37(3), 52-58.

Mundt, J. P., & Connors, J. J. (1999). Problems and challenges associated with the first years of teaching agriculture: A framework for preservice and inservice education. *Journal of Agricultural Education*, 40(1), 38-48.

Myers, B. E., Dyer, J. E., & Washburn, S. G. (2005). Problems facing beginning agriculture teachers. *Journal of Agriculture Education*, 46(3), 47-55.

Meet, Greet, Compete and Eat: Learning by Doing- Leadership Contest

Wendie Clubine
PO Box 3011
Commerce, TX 75429
(620) 779-1409
wclubine@leo.tamu-commerce.edu
Texas A&M University- Commerce

Dr. Robert Williams
PO Box 3011
Commerce, TX 75429
(903) 886-5350
bob_williams@tamu-commerce.edu
Texas A&M University- Commerce

Meet, Greet, Compete and Eat: Learning by Doing- Leadership Contest

Need for Innovation

According to Kolb (1984), as described by Roberts (2006), learning is the process of creating knowledge. Concrete experience occurs when one has direct contact with the phenomenon being studied. During this stage, learners grasp information through implementation of the senses; to see, hear, smell, feel or taste the phenomenon (Roberts, 2006). High expectations are placed on college students preparing to become secondary agriculture teachers. Experiential learning can teach pre-service agriculture teachers lessons that would be difficult to learn from a textbook or classroom lecture.

Leadership Development Events are a critical aspect of the high school FFA experience. Some pre-service agriculture instructors experienced LDE contests firsthand through their own FFA involvement; however, this is not true for all. This innovation introduces college students to the programming and coordination responsibilities of hosting a Leadership Development Event. Potential instructors become familiarized with the contests and expectations associated with the event.

This innovation is further beneficial as a social networking event. Pre-service teachers meet current agriculture instructors, which could benefit their future career. Participants in the contest socialize with other FFA members and college students. The attributes, in accordance with Rogers (2003), of this innovation are favorable for widespread adoption. The rate of diffusion depends greatly on the qualities of the innovation; relative advantage, compatibility, complexity, trialability and observability. The advantages of this process include experience gained by college students that will be greatly beneficial in the future and the contests are hosted by coordinators who have a personal interest in the process. This innovation is highly compatible with society, as experience is valued in the workplace. The complexity of this process is not extensive, as classroom curriculum prepares college students for such programs. Due to the fact that this course has new students each semester, each year has new coordinators; pre-service agriculture instructors are able to use this experience as a trial run for their teaching career. Furthermore, the observability factor is high; people outside of the class are clearly able to see how involved the college students are.

Methodology

Students enrolled in the Agricultural and Youth Leadership course selected Leadership Development Event contests that they would like to coordinate. Depending on the contest, more than one coordinator was necessary. The student(s) familiarized themselves with the rules of the contest, secured judges, prepared packets for judges, managed the schedule of participants, compiled judges' results, and presented awards. The judges' packets included anything the judges needed; including copies of the rubrics, rules, and FFA Creed for certain contests.

On the day of the event, students coordinated and facilitated the set up in the competition room, checked that judges have everything necessary for the event and organized participant competition order. After the judging was completed, the event coordinator compiled all of the

results from each judge to tally the participants' scores. Coordinators then returned the contest room to its normal state and presented the awards to the top three ranking individuals. Participants and coordinators, as well as everyone else involved with the event, were able to socialize over grilled hotdogs. The hospitality committee organized a dinner of hotdogs, chips and cookies to be prepared and served to FFA members after contests and before the presentation of awards.

Results to Date

Observable results indicated that participants, and coordinators alike, thoroughly enjoyed the experienced; evidenced by the camaraderie and shared good nature. Through discussion afterwards of the event, class members overwhelmingly agreed that through coordinating the contests, they were more prepared to judge a district or area level competition. A vast majority of the class members also felt that this experience would benefit them greatly in the future, by giving firsthand experience working directly with secondary agriculture students.

Future Plans and Advice to Others

Future Leadership Development Events hosted in this manner will undoubtedly maintain the same level of experiential learning. Clear instructions for the student coordinators are imperative to a successful event. Furthermore, coordinators should be well informed of available resources. The contest will continue to be hosted at this University in this manner due to its immense success. This model can, and perhaps is, used by other pre-service preparation programs.

Costs and Resources

Collegiate FFA served as the "fiscal agent" as well as the secondary host organization for the event. The budget for 2010 is provided below.

<u>Expenses</u>		<u>Revenue</u>	
Copying	\$140	Entries	\$1680
Hospitality supplies	\$260		
Miscellaneous supplies	\$25	<u>Net Income</u> for Collegiate FFA	
Awards	<u>\$510</u>		\$745
Total	\$935		

References

- Roberts, T. G. (2006). A Philosophical Examination of Experiential Learning Theory for Agriculture Educators. *Journal of Agriculture Education*, 47(1), 17-29.
- Kolb, D. A. (1984). *Experiential learning: Experience as the source of learning and development*. Upper Saddle River, NJ: Prentice Hall.
- Rogers, E. M. (2003). *Diffusion of Innovations*. Free Press: New York, NY.

Paving a Road to Success with the Agriculture /Academic Integration Project

Yvette Smith
University of Georgia
1301 Sunset Circle
Statesboro, GA 30458
912-682-2869
ysmith13@uga.edu

Diana L. King
University of Georgia
P.O. Box 748
Tifton, GA 31793
229-386-6533
dlking@uga.edu

Paving a Road to Success with the Agriculture /Academic Integration Project

Introduction/Need for Innovation

Implementing Heron's Formula? Writing a research paper? How are these things related to a career in agriculture? Many students express their concern with learning such academic theories and skills because they don't see the importance or relevance those skills and theories have in their adult lives and future careers. How does trigonometry and AP literature really apply to what the student will do as a working citizen in an agriculture career or just as an adult in general?

In an effort to promote the positive, complimentary relationship between academics and agriculture education, a partnership was developed between the teachers of core subject areas and agriculture courses. The Agriculture/Academic Integration Project was designed to help students see the benefit of academic skills in agriculture career scenarios. The partnership helped both students and teachers alike, as academic teachers were exposed to a new way of applying the skills students learn in their classes to real job experiences in agriculture industry. This project directly supports the initiative to provide rigorous, relevant, standards-based curriculum in agricultural, food, and natural resource systems as mandated in the National Research Agenda (Osborne, 2007) and goes a step further to enhance learning in core academic areas through real world application in agriculture. According to Edwards (2003), partnerships with science, math and reading teachers can help demonstrate the relevance of agriculture to cross-curriculum learning and the Agriculture/Academic Integration Project puts that idea into practice.

How It Works

The first step in the Agriculture /Academic Integration Project was to determine the student's schedules to identify if there was an academic class that the majority of students were taking. Agriculture Educators were given the task of identifying projects already planned for the courses they taught and to determine if an academic subject was embedded (or could be easily incorporated) within the project. Determining an academic teacher to partner with and arranging a date and time to plan the integration project was the next step in the process. The [State] Performance Standards, available online, proved a valuable resource as the standards for both the agriculture course and the standards related to each academic core subject area are listed ([State] Agriculture Education, 2010). Using the standards as a guide, work began on a common project/assignment. Both teachers developed a pre assessment, instructional strategies utilizing like terminology for both the academic area and agriculture area, and a summative assessment. Both teachers were responsible for implementing the project/assignment and reviewing the whole process upon completion.

An example of a project partnering forestry science and trigonometry was conducted last fall. The forestry unit of study was entitled Land Measurement. Students learned how to use a compass, pace to determine distance, and utilize tools to draw a map of the area surveyed. With this knowledge, forestry students met with trigonometry students in the school cafeteria to teach them all about compasses, pacing and drawing maps. The trigonometry students in turn were

learning about determining area. Working cooperatively the partner pairs (forestry students and trigonometry students) used bearings and distances to draw a map and determine total land area of that surveyed plot. Both students were able to see firsthand the real world application of the academic skills they learned. The teachers shared the project idea with the school's leadership team, administrators and CTAE Director. The key was combining a solid academic core with a strong career focused course and both academic and agriculture teachers who recognized the value of both areas of study.

Results to Date

Teachers were asked to share their cooperative projects/assignments at the end of each semester. Project ideas were shared with other members of the Career, Technical and Agriculture Education department. Academic teachers were asked to complete a short survey on the impact the integration project had on student's success in understanding the core area standards covered and how they felt about partnering with agriculture teachers. Agriculture teachers were surveyed to determine their thoughts on the success of the project, the planning process, difficulty in determining a project/assignment to share, increase in knowledge of agriculture students and likelihood of developing another project or assignment with an academic teacher in the future.

Academic teachers reported:

“Students really got it after they saw the real world application.”

“I didn't see all the possibilities that partnering with an agriculture teacher had to offer, I do now.”

Agriculture teachers reported:

“Even I learned a few shortcuts from the project partnering with our trigonometry teacher.”

“I thought finding a project to do together would be hard, but once I got started looking the opportunities are endless.”

“It was nice to work with an individual teacher outside of the agriculture field. Her perspective was so different and I think we both learned a lot from each other.”

Future Plans

Plans are underway to continue to promote the partnership project between academic teachers and agriculture educators to build the interpersonal relationships between teachers and create projects and assignments that connect academic skills with a career focused program. Our hope is to share this idea with our state agriculture education staff and provide resource information (project ideas/assignment basics) on the [State] Agriculture Education website for all agriculture teachers to utilize in their schools.

Costs/Resources Needed

The only cost for this project was for consumables directly required for activities, if needed. Resources needed include performance standards for both agriculture and academic courses.

References

- Edwards, M. C. (2003). Cognitive learning and student achievement in secondary level agricultural education: a synthesis with implications for the future. *Proceedings of the 22nd Annual Western Region Agricultural Education Research Conference, Portland, OR*. Retrieved from: <http://www.agedweb.org/WRAEC/2003/papers/Edwards.pdf>
- [State] Career Technical and Agriculture Education. (2010). *Curriculum Standards*. Retrieved from: [http://www.\[state\]ctaern.org/](http://www.[state]ctaern.org/)
- Osborne, E. W. (Ed.) (2007). National research agenda for agricultural education and communication: 2007-2010. Published by the American Association for Agricultural Education.

Preparing Undergraduate Students for Agricultural Advocacy

Mr. Chaney W. Mosley
Virginia Polytechnic Institute and State University
2270 Litton Reaves Hall
Blacksburg, VA 24061
540-231-6836
cmosley@vt.edu

Ms. Keyana Ellis
Virginia Polytechnic Institute and State University
2270 Litton Reaves Hall
Blacksburg, VA 24061
540-231-6836
keyellis@vt.edu

Ms. Michelle Greaud
Virginia Polytechnic Institute and State University
2270 Litton Reaves Hall
Blacksburg, VA 24061
540-231-6836
mbrookne@vt.edu

Ms. Lisa Hightower
Virginia Polytechnic Institute and State University
2270 Litton Reaves Hall
Blacksburg, VA 24061
540-231-6836
lisah829@vt.edu

Dr. Eric Kaufman
Virginia Polytechnic Institute and State University
2270 Litton Reaves Hall
Blacksburg, VA 24061
540-231-6258
ekaufman@vt.edu

Preparing Undergraduate Students for Agricultural Advocacy

Introduction

A combination of media attention and empirical studies (Agbaje, Martin, & Williams, 2001; Cotton, 2006; Fraser, 2001) highlight the controversial nature of production agriculture. Be it plant or animal production, characteristics of these topics induce conflicting thoughts, beliefs, and values. Fraser (2001) suggests that disagreements about the ethics involved with production agriculture often manifest in the form of emotionally charged claims that do not accurately represent the agricultural industry. For argumentative critics of modern production techniques, a common tactic is to demonstrate a defensive position that attacks production agriculture, while the critic portrays confidence and competence (Rancer, Kosberg, & Silvestri, 1992) that is highly effective in persuasion situations (Infante & Gorden, 1985, 1987, 1989). Agriculturists must learn to recognize and use persuasive techniques. Acknowledging when these techniques would assist in communicating a positive response is key to purposeful advocacy (Public International Law & Policy Group [PILPG] & Baker & McKenzie International, 2007).

Advocacy involves “pleading a cause, or encouraging someone to support, speak, or write in favor of a particular behavior or action” (Johnson & Mappin, 2005, p. 2). Much of advocacy, then, requires the employment of persuasion. While persuasion methods commonly involve written language and spoken word, “body language, facial expression, tone, and even silence” (PILPG & Baker & McKenzie, 2007, p. 43) are also essential elements to the art of persuasion. According to Brinol and Petty (2008), body movements offer cues to one’s attitude. An awareness of the meaning behind body movements and facial expression can enhance the effectiveness of advocacy efforts, which is crucial for responding to activists (Hon, 2006).

According to Hon (2006), messages of activists are often planned to have shock value that will gain media attention. As new media forms emerge, such as blogs and wikis, activists increase the possible audience that can be reached (Hon, 2006). The Internet has become a popular avenue for distributing campaigns against certain agricultural practices, increasingly through electronic video formats. According to Caldwell (2005), video is effective at having a “powerful emotional impact, connecting viewers to personal stories” (p. 2). As activists increase efforts to displace modern production agriculture, a sense of urgency is created for the agricultural industry, especially the future workforce, to develop the skills needed for effective advocacy.

How It Works

Preparing undergraduate students for agricultural advocacy involves many steps. First, the Animal Attitudes Scale (AAS) (Herzog, Betchart, & Pittman, 1991) is administered to determine attitudes toward animal rights and animal welfare. The AAS, available for free online, assesses individual differences in attitudes toward the treatment of animals through a 20-item Likert-type instrument. Student scores are assessed on the AAS to determine whether they hold attitudes consistent with animal rights or animal welfare. Based on the results, students are then assigned to one of two groups (animal rights or animal welfare) for the purpose of viewing a short video that advocates for issues opposite the viewpoint of the student. For example, students whose scores on the AAS indicate attitudes in line with animal rights watch a video promoting animal welfare through persuasive methods. Similarly, students in the animal welfare group watch a video clip advocating for animal rights in the same manner. Prior to watching the videos,

students receive a lecture describing the components of advocacy in agriculture and the use of persuasive communication. After watching the video, students complete an assignment using the skills they learned about advocacy. Specifically, students in a written communication course develop a press release, while students in an oral communication course develop a series of talking points that could be used when delivering a live interview statement to the press.

Results to Date / Implications

In a written communication course and an oral communication course for undergraduates in agriculture, students completed an attitude test regarding animal rights and animal welfare. Also, students watched videos in contradiction with held beliefs for the purpose of demonstrating media advocacy from a competing viewpoint and increasing student motivation to respond. After observing the videos, students discussed persuasive techniques used in the videos to identify the appropriateness and effectiveness of persuasion. This discussion guided the development of press releases and interview statements in a response effort.

This idea has many implications for agricultural education. Because undergraduate students in agriculture represent the future workforce of the industry, knowledge of responsible advocacy is important. Advocacy is a context-specific skill that involves pleading a case using facts and persuasive speech to convince an audience of the importance of a position on a specific topic. Those working in agriculture and natural resource industries often face a barrage of media stories that influence public opinion concerning agricultural production and practices. Media advocacy is “the strategic use of the mass media as a resource to advance a social or public policy initiative” (Jernigan and Wright, 1996, p. 306). As future agricultural professionals, learning media advocacy using communication skills, both written and oral, equips undergraduate students with skills to develop sound arguments in response to media representatives in the form of press releases and interviews and enables them to advocate for their respective fields.

Future Plans / Advice to Others

Faculty and graduate students are designing a research study that will involve undergraduate students in the College of Agriculture and Life Sciences. In this study, students will receive instruction related to advocacy and the art of persuasion according to the steps identified in the methodology section. Prior to a instruction about advocacy, students will be given a Likert-type pretest to determine attitudes toward animal rights and animal welfare. After watching the video and completing the accompanying assignment, students will respond to open ended questions about the exercise and their personal feelings about the ability to advocate for the agricultural industry. Ideally, this study will result in the development of an instructional model for teaching advocacy and a scale to measure knowledge and efficacy in regard to advocacy. Others using this idea in college classrooms should consider asking students to submit controversial topics in agriculture and search YouTube for videos that compete with held attitudes.

Costs / Resources Needed

This innovative instructional method requires a computer equipped to play DVDs, a projector and a projection screen, a video advocating for animal rights, and a video advocating for animal welfare. Additionally, an attitude test is necessary for each student. Costs associated with this innovation exist in the form of printing expenses. The actual cost for this project during fall 2010 semester was \$2.27 for printing.

References

- Agbaje, K., Martin, R., & Williams, D. (2001). Impact of Sustainable Agriculture on Secondary School Agricultural Education Teachers and Programs in the North Central Region. *Journal of Agricultural Education*, 42(2), 38-45.
- Brinol, P., & Petty, R. E. (2008). Embodied persuasion: Fundamental processes by which bodily responses can impact attitudes. In G. Semin & E. Smith (Eds.), *Embodiment grounding: Social, cognitive, affective, and neuroscientific approaches* (pp. 184-210). New York: Cambridge University Press.
- Caldwell, G. (2005). Using video for advocacy. In S. Gregory, G. Caldwell, R. Avni, & T. Harding (Eds.), *Video for change – A guide for advocacy and activism* (pp. 1-19). London: Pluto Press.
- Cotton, D. (2006). Teaching controversial environmental issues: Neutrality and balance in the reality of the classroom. *Educational Research*, 48(2), 223-241.
- Fraser, D. (2001). The “new perception” of animal agriculture: legless cows, featherless chickens, and a need for genuine analysis. *Journal of Animal Science*, 79, 634-641.
- Herzog, H. A., Betchart, N. S., & Pittman, R. (1991). Gender, sex role identity and attitudes toward animals. *Anthrozoos*, 4, 184-191.
- Hon, L. (2006). Negotiating relationships with activist publics. In K. Fitzpatrick & C. Bronstein (Eds.), *Ethics in public relations – Responsible advocacy* (pp. 53-69). Thousand Oaks, CA: Sage Publications, Inc.
- Infante, D. A., Step, M. M., & Horvath, C. L. (1997). Counterattitudinal advocacy: When high argumentatives are more persuasible. *Communication Research Reports*, 14(1), 79-87.
- Jernigan, D. H. and Wright, P. (1996). Media advocacy: Lessons from community experiences. *Journal of Public Health Policy*, 17(3), 306-330.
- Johnson, E, & Mappin, M. (2005). *Environmental education and advocacy - Changing perspectives of ecology and education*. New York: Cambridge University Press.
- Public International Law and Policy Group, & Baker & McKenzie International. (2007). *The international negotiations handbook: Success through preparation, strategy, and planning*. Retrieved from http://www.bakermckenzie.com/files/Uploads/Documents/Supporting%20Your%20Business/Featured%20Services/bk_internationalnegotiationshandbook_dec07.pdf

Preparing Young Leaders for Sustainable Agriculture Practices in West Virginia

John Lockhart
Undergraduate Student
West Virginia University
2049 Agricultural Science Building
Morgantown, WV 26508-6108
304-293-4832
jlockhart2@mix.wvu.edu

Matt Coe
Undergraduate Student
West Virginia University
2049 Agricultural Science Building
Morgantown, WV 26508-6108
304-293-4832
mcoe@mix.wvu.edu

Douglas D. LaVergne
Assistant Professor
West Virginia University
2044 Agricultural Science Building
Morgantown, WV 26506-6108
304-293-5536
doug.lavergne@mail.wvu.edu

Preparing Young Leaders for Sustainable Agriculture Practices in [State]

Introduction

Production agriculture in [State] has seen a decrease in numbers over the past several years. Production numbers indicate a 10% decrease in cattle and sheep production, along with a 29% decrease in swine production, and a loss of more than 4.5 million birds in poultry production during the last 10 years (Annual Bulletin 41, 2010). This information, combined with the fact that the number of farms and total acreage farmed have remained the same (Annual Bulletin 41, 2010), raises many concerns about production practices and land usage in the state. Based upon these statistics, coupled with candid conversations with production agriculture professionals across the state, it is clear that the need to prepare individuals for sustainable agriculture practices is paramount. Because of this dilemma, it was determined that innovative strategies should be implemented to address this situation. While the state works collaboratively to reverse this trend, one approach put into practice was preparing future leaders toward sustainable agricultural practices. By creating awareness and adequately educating young farmers and ranchers about emerging and sustainable production strategies, we can ensure that the state will be equipped with educated professionals that will be able to maintain and increase production agriculture numbers for years to come.

How it Works

The workshop was conducted in conjunction with the [State] FFA Career Development Event (CDE) Competitions at [State] University. Participants consisted of middle and high school students that were in attendance. Notice of the workshop was emailed to state agricultural education teachers one month earlier. Prior to the workshop, the researchers developed a program plan that addressed proven sustainable farming practices and strategies that would promote implementation throughout the state. The progression of the workshop was completed in three parts. First, the researchers introduced the topic of sustainable agriculture through informational media detailing [State]'s production numbers and the need for sustainable agricultural practices. Secondly, the researchers engaged the group in a dialogue about their perceptions of sustainable farming practices and strategies that would aid in the improvement of production agriculture. Next, participants identified and discussed possible solutions that would allow them to become advocates for sustainable agriculture practices.

Educational Benefits

Students received an overview of agricultural production facts and figures from the previous year. This included statistics involving: the total number of farms, the total acres harvested, and the total production numbers for the state's major commodities. Although this information is available for public interpretation, the researchers focused on teaching students how to interpret the data and encouraged them to explain the information to other students.

Results

Sixty students attended the workshop. It should be noted that many students in attendance were members on most of the livestock, dairy, plant, forestry, and agronomy teams (or individual events) that were competing in the state CDE competitions. Because the program is in the beginning phases, the results of knowledge gained and perceptions changed are difficult to determine at the moment. However, every participant was enthusiastic and seemed to have a vested interest in the topic. The purpose of the workshop was to generate tangible ideas toward developing sustainable production practices and strategies for advocacy in its practice. The top practices and strategies were highlighted.

Practices for Sustainability

Strategies for Advocacy

-
- | | |
|---|--|
| <ul style="list-style-type: none"> • Selection of alternative livestock breeds suited for [state] ecological conditions • Increase research based Supervised Agricultural Experiences (SAE's) involving sustainable practices • Increase focus on value added products through crop specialization • Starting local cooperatives to increase funds for sustainable practices • Utilize alternative feed additives to increase feed efficiency | <ul style="list-style-type: none"> • Hosting local workshops to introduce sustainable agricultural practices • Develop sustainable agriculture workshops/programs targeting lower grade levels • Establish local newsletter highlighting sustainable agriculture practices • Increase collaboration with extension personnel • Develop community based websites for sustainable agriculture advocacy |
|---|--|
-

Future Plans

Future plans include offering the workshop at various locations throughout the state. Efforts to collaborate with state organizations such as the [State] FFA Association, and the [State] Cooperative Extension service, will be attempted. Future plans also include: preparing former workshop participants to be the host of similar workshops in their communities, advertising the workshop through the state's agricultural teachers association, and working in collaboration with other state FFA officers in presenting a similar workshop in other states and at the National FFA Convention. Grant opportunities from the Sustainable Agriculture Research and Education Program (SARE) are available and this program will be reviewed for possible submission.

Cost/Resources Needed

The workshop was conducted by members of the state FFA officer team and was not given a set budget. Because many of the items were part of the state officer's resources, total operational cost is difficult to determine. A list of items needed (and cost) is provided.

- Workshop location: Researchers secured a location with the host institution of the state's career development event competition. This was accomplished by sending the workshop proposal to the CDE coordinator.
- Educational and instructional resources: *The Arsenal: A Complete Guide to Team Performance and Improvement and Effective Workshop Development* (State officer manual acquired from the National FFA Organization), *[State] Department of Agriculture, Bulletin No.41* (no cost), *What is Sustainable Agriculture?* (no cost), *Youth Renewing the Countryside* (no cost).
- Miscellaneous items: paper, pens, markers, and easel pads (\$25.00).

References

[State] Department of Agriculture, USDA-NASS [State] Field Office. (2010). *2010 Annual Bulletin NO. 41*. Retrieved from [http://www.nass.usda.gov/Statistics_by_State/\[State\]/Publications/Annual_Statistical_Bulletin/Bulletin2010-All.pdf](http://www.nass.usda.gov/Statistics_by_State/[State]/Publications/Annual_Statistical_Bulletin/Bulletin2010-All.pdf)

National Institute of Food and Agriculture, Sustainable Agriculture Research and Education.
(2010). *What is sustainable agriculture?*. Retrieved from
<http://www.sare.org/publications/whatis/whatis.pdf>

National Institute of Food and Agriculture, Sustainable Agriculture Research and Education.
(2010). *Youth renewing the countryside*. Retrieved from
<http://www.sare.org/publications/youth/youth.pdf>

Sam's Big Adventure; An Innovative Educational Intervention for Children

Authors:

Joel D. Ray, DVM
Susan Seal, PhD MBA
Michael Newman, PhD

P.O. Box 6100
Mississippi State, MS 39762

(662)325-3432

Email:

Ray - joray@cvm.msstate.edu
Seal - seal@cvm.msstate.edu
Newman - mnewman@humansci.msstate.edu

Sam's Big Adventure; an Innovative Educational Intervention for Children

Introduction

Pet Awareness with Students or P.A.W.S. began as a pilot project to educate elementary aged children about public health concerns. It has grown into a student led program that may be incorporated into the curriculum of the Community Veterinary Service at [University] College of Veterinary Medicine. The goal of P.A.W.S. is to educate children about public health topics such as zoonotic diseases, bite prevention, pet care, and the world of veterinary medicine. We also attempt to develop and evaluate methods of educating children in matters related to public health and animal issues, such as zoonotic diseases, animal behavior, handling pets and veterinary basics. We emphasize basic hygiene and animal handling as a means of prevention of public health issues through most of our talks.

The lessons vary based on the age of the students. Kindergarten and first grade students listen to hearts, play with an animated dog named Samantha (Sam) and enjoy a reading time when they role-play a story about a pet's visit to the doctor. Second through fourth graders learn about puppy and kitten care, pet behavior, pet needs and sanitation issues. Fifth and sixth graders learn about zoonotic diseases and the role of veterinarians to keep pets healthy. This year first and second graders learned about reading animal behavior and bite prevention.

Objectives/Rationale

It is the objective of this project to develop an educational program for kindergarten and first grade children that utilizes imagination and role-playing to correlate medical visits that they might have with a visit that Samantha had. After participating in this program, children will be more comfortable with their own medical visits, role-play as a veterinarian and understand the role of the veterinarian as the other family doctor.

Methodology

Kindergarten and First grade students enjoy the transformation into veterinarians. We read a book called *Sam's Big Adventure*. In our story, Samantha (Sam), the golden retriever visits Dr. Sally Benice, a veterinarian, for a sore tummy. As we walk Sam through a veterinary visit, children are clothed in appropriate medical outfits and perform a physical examination as a veterinarian. Examples of such functions include eye and ear exams, and heart auscultation. As Sam has an x-ray taken of her sore belly, a "junior" doctor, dressed up as a radiologist, makes the diagnoses of a metal foreign body in the stomach. An operation is necessary for her treatment and Sam is prepared for surgery. The "junior" doctors don scrub tops, surgery gloves, surgery mask and cap to perform the exploratory. The successful surgery removes a coin and Sam recovers uneventfully and barks thanks. As the story ends, the students learn that just like Sam, they may need to go to the hospital. They may undergo or have previously undergone some of the same tests and procedures. They learn that even though they may be afraid and uncomfortable for a short time, just like Sam, knowing what goes on makes things less scary. This program utilizes interactive learning to allow children to expand their knowledge by building on their own experiences or previous knowledge.

Results to date/implications

The pilot project was conducted during the 2009-2010 school year to 21 first grade, kindergarten and preschool classes. The *Sam's Big Adventure* book was made available through [University] Extension Service as well as coloring books, bookmarks and activity books developed to reinforce the material and provided to participants. Interviews with the teachers and the veterinary students did reveal that the children could comprehend the material and did

enjoy the method of a story and role-playing. The current success of the program has created opportunities to expand the program to schools located outside of our area. The program has been presented to 4-H agents and volunteers throughout the state. Through that train-the-trainer venue, we provided information in regards to implementing the program in further locales.

Future plans/advice to others

We proposed that the program become a part of Community Veterinary Service at the College of Veterinary Medicine at [University]. As the program becomes established, we hope to utilize veterinary students in the rotation to experience public health education and community outreach. Including veterinary students through this rotation ensures that the program is sustainable and not only provides educational experiences for the kindergarteners, but also for our veterinary students.

Costs/resources needed

Implementation of the described program required lab coats, stethoscopes, ophthalmoscopes and otoscope. We utilized a radiograph with a metal foreign body for the diagnosis. To simulate the surgery, scrub shirts, disposable surgery masks, caps, and foot covers were utilized. Many of these items may either be borrowed from a local veterinarian or purchased from suppliers. The most costly item obtained was the mechanical dog. More information about the toy may be found at <http://furrealfriendsbiscuit.com/>. The dog that we used sells for approximately \$200.00

References

- American Veterinary Medical Association. (2005). *Helping children cope with surgery*. Schaumburg .
- Fizzano, W. J. (2000, May). The impact of story drama on the reading comprehension, oral language complexity and the attitudes of third graders. *Dissertation Abstracts International Section A Humanities and Social Sciences* . US: ProQuest Infotmation & Learning.
- Pellegrini, A., & Galda, L. (1982, September 21). The effects of thematic-fantasy play training on the development of children's story comprehension. *American Educational Research Journal* , 443-452.
- Umaschi Bers, M., & Cassell, J. (1998). Interactive storytelling systems for children: using technology to explore language and identity. *Journal Of Interactive Learning Research* , 183-215.

Simulation: Innovations toward Bridging Social Cultures through Agricultural Education

Jonathan A. Tubbs
Agricultural Education
Department of Community and Leadership Development
University of Kentucky
307 Garrigus Building
Lexington, KY 40546-0215
(859) 257-7578
Fax: (859) 257-1164
jonathan.tubbs@uky.edu

Stacy K. Vincent
Agricultural Education
Department of Community and Leadership Development
University of Kentucky
505 Garrigus Building
Lexington, KY 40546-0215
(859) 257-7588
Fax: (859) 257-1164
stacy.vincent@uky.edu

Bryan J. Hains
Agricultural Education
Department of Community and Leadership Development
University of Kentucky
507 Garrigus Building
Lexington, KY 40546-0215
(859) 257-7578
Fax: (859) 257-1164
bryan.hains@uky.edu

Simulation: Innovations toward Bridging Social Cultures through Agricultural Education

Introduction/Need for Innovation or Idea

McPherson, Smith-Lovin, and Cook stated “By interacting only with others who are like ourselves, anything that we experience as a result of our position gets reinforced. It comes to typify ‘people like us’” (2001, p. 415-416). Since agriculture teachers from ethnic minority populations are highly underrepresented in education (Warren & Alston, 2007) and have limited cross-cultural interaction (Brown, 2004), then it can be assumed social cultures are not represented as well. Kipnis (2001) identifies these cultures as any group organized around occupation, a common activity, age, status (SES), ethnic group/background, race, religion or any other unifying social condition.

In order to maintain its appeal, agricultural education teachers must recognize student cultural transitions and adapt their practices to be more inviting to a wider audience through persistence, encouragement and a positive influence (Talbert & Edwin, 2008). However, when pre-service teachers in a Midwestern state university were evaluated on concern levels toward teaching students who were culturally different from themselves, results showed that students in agricultural education were of least concern (Vincent, Killingsworth, & Torres, 2010). This lack of concern can result in student classroom enrollments that display a homogenous culture to that of the teacher (Wehlage & Rutter, 1986). In order to better equip future agriculture teachers to bridge social cultures, the University of [STATE] is utilizing innovative ideas through immersion and simulation.

How it Works/Methodology/Program Phases/Steps

AED 670: Advanced Methods in Teaching Career and Technical Education, and AED 580: Foundations of Teaching Career and Technical Education, allows students the opportunity to enhance their knowledge of cultural and social differences through simulation, research, and implementation in immersion situations within foreign cultures.

In AED 670, students are challenged to create for themselves an alter-identity to enhance their cultural and social understanding. Students base their alter-identity off of a population or subculture they do not understand or have little understanding of. Examples include Goth, low SES, teenage mothers, and learning disabled. Once selected, students extensively research the population to construct an in depth understanding of their role. The research process is flexible and students are encouraged to extend beyond journals to include personal interaction, observations, and interviews. The precursor research helps students connect to their alter-identity both cognitively and emotionally. Once created, students enact their roles through immersion in a public forum; in the case of this course a public mall is selected. Following the role play, the class engages in a reflection followed by a written personal reflection.

AED 580 immerses students into culturally challenging situations that are encountered within the teaching profession. Students establish a cognitive grasp on cultural situations through role play simulation of various roles (community pastor, parent, grandmother, peer, or teacher) associated within a chosen community. Students then establish how the situation (homosexual teachers and students, pregnant students, students of different socioeconomic statuses, students dealing with violence/drug abuse) will be handled according to the morals and ethical positions

of their role. After setting these foundations, students research and enact their role within the public simulation; in the case of this course, a school board meeting. Following the simulation, students reflect in a personal written piece.

Results to date/Implications

Through the immersion situations facilitated in AED 580 and AED 670, many parallels between results were generated in reflections. The character simulation and classroom role play prompted an understanding of diverse student identities, quality reflection and professional growth development. From the experiences, students returned with feelings of disbelief and frustration, which in turn created empathy and a desire to understand the cultures more in depth. These reactions indicate depth of intrapersonal development the students went through as a result. Through these experiences, students' were challenged in their personal identity, emotionally and cognitively, leading to a deeper understanding for the population they were portraying, studying, and simulating. These implications help provide data indicating that teacher training programs should extend beyond intellectualization about multicultural issues and into examination and experimentation (Bell, 2000).

Future Plans/Advice to Others

Limitation to student cultural understanding occurs when they do not fully research and immerse themselves into the settings in a stand-alone course (Brown, 2004). This occurrence often centers on pre and in-service teachers who have by-passed challenging and uncomfortable situations concerning cultural diversity, social identity, and population divergence due to a lack of understanding. Proactive measures can be taken by establishing the rationale for cultural understanding and instilling within students a need for understanding and knowledge. Infusing immersion practices within other current and future coursework will aid in reinforcement and continuation of the students' education on social identity and multicultural situations.

As Brown (2004) indicated, single multicultural immersion or simulation is not enough to cultivate cultural understanding. Woods (2004) also contends that there is a substantial difference between those that simply preach cross-cultural appreciation and those that live it. The results of these cultural exercises have prompted implementation into a majority of both undergraduate and graduate curricula. Through continuous and qualitative innovations into these curricula, social cultures will begin to bridge through agricultural education.

References

- Bell, L. C. (2000). A Longitudinal Measure of the Perceptual Impact of a Cultural Diversity Teaching Practicum on the Interpersonal Competency of Student Teachers. *Journal of Agricultural Education*, 41(2), 11-18. doi:10.5032/jae.2000.02011
- Brown, E. L. (2004). What Precipitates Change in Cultural Diversity Awareness during a Multicultural Course: The Message or the Method? *Journal of Teacher Education*, 55(4), 325-340. doi:10.1177/0022487104266746
- Kipnis, A. (2001). Articulating School Countercultures. *Anthropology & Education Quarterly*, 34(4), 472-492. Retrieved from <http://www.jstor.org/stable/3195971>

- McPherson, M., Smith-Lovin, L., & Cook, J.M. (2001). Birds of a Feather: Homophily in Social Networks. *Annual Review of Sociology*, 27, 415-444. Retrieved from <http://jstor.org/stable/2678628>
- Talbert, B. A., & Edwin, J. (2008). Preparation of Agricultural Education Students to work with Diverse Populations. *Journal of Agricultural Education*, 49(1), 51-60. doi:10.5032/jae.2008.01051
- Vincent, S. K., Killingsworth, J. L., & Torres, R. M. (2010). *Determinants of concern of multiculturalism among secondary preservice teachers*. Paper presented at National American Association for Agricultural Education Research Conference, Omaha, NE.
- Warren, C. K., & Alston, A. J. (2007). An Analysis of Diversity Inclusion in North Carolina Secondary Agricultural Education Programs. *Journal of Agricultural Education*, 48(2), 66-78. doi:10.5032/jae.2007.02066
- Wehlage, G. G. & Rutter, R. A. (1986). Dropping Out: How Much Do Schools Contribute to the Problem? *Teachers College Record*, 87, 374-392.
- Woods, M. D. (2004). Cultivating Cultural Competence in Agricultural Education through Community-Based Service-Learning. *Journal of Agricultural Education*, 45(1), 10-20. doi:10.5032/jae.2004.01010

**The Lesson Plan Blitz: Assisting Pre-Service Teachers
Through Their Zone of Proximal Development**

Mr. Cory M. Epler
Virginia Polytechnic Institute and State University
1830 Litton-Reaves Hall
Blacksburg, VA 24061
Phone: 540.231.7422
Fax: 540.231.3824
cepler@vt.edu

Dr. Thomas W. Broyles
Virginia Polytechnic Institute and State University
268 Litton Reaves Hall
Blacksburg, VA 24061
Phone: 540.231.8188
Fax: 540.231.3824
tbroyles@vt.edu

The Lesson Plan Blitz: Assisting Pre-Service Teachers Through Their Zone of Proximal Development

Introduction/Need for Innovation

The shortage of teachers hits home to those involved in Career and Technical Education (CTE) and specifically, Agricultural Education. According to Camp, Broyles, and Skelton (2002), a pressing issue facing Agricultural Education is a shortage of teachers to fill existing and future agricultural education programs. Additionally, the National Research Agenda for Agricultural Education and Communication (2007) states that teacher turnover is a concern in all fields of education, especially Agricultural Education. With this in mind, researchers continue examining factors that attribute to the lack of teacher retention, and it is noted many agricultural teachers leave the profession early in their career. To combat this attrition, many schools have implemented programs designed to assist beginning teachers, but these programs often do not address the instructional issues beginning teachers face. A study by Kirby and LeBude (1998) examined beginning teacher induction programs. Results indicated that these programs provide emotional support and procedural information, but often do not address the teacher's need for time and planning (Kirby & LeBude, 1998). Therefore, it becomes necessary to prepare pre-service teachers for the instructional demands that will be placed upon them during their first years of teaching.

An important area of pre-service teacher development is curriculum planning and lesson plan development. It is a common practice for pre-service teachers to develop curriculum and/or lesson plans as part of their training. While this exercise is practical and necessary, it often is not a realistic representation of the amount of time a teacher has to develop daily lesson plans while teaching. When considering this process, Vygotsky's research and the Zone of Proximal Development (ZPD) should also be considered. The ZPD is the difference between what a learner can do on their own and what they can do with assistance from others (Shunk, 2006; Vygotsky, 1978). When it comes to curriculum development and lesson planning, the movement of pre-service teachers through their ZPD is critically important. Teacher educators must help pre-service teachers transition from lesson planning with assisted performance to the unassisted reality that awaits them as they enter the field.

Within our teacher preparation program, we observed that pre-service teachers were spending hours crafting extensive and elaborate lesson plans. That same trend carried over into their teaching internship. The pre-service teachers were spending the same amount of time planning their lessons as they did prior to their teaching internship, but they were facing the reality that it was taking too much time. To challenge the mindset that the best lesson plans take hours to plan, the idea for a "Lesson Plan Blitz" emerged. The goal of the Lesson Plan Blitz was to challenge the pre-service teachers' beliefs that lesson planning is a process that takes hours to complete.

How it Works

Pre-service teachers received a list of eight general task/competencies for their specific CTE program area (Agricultural Education, Business and Information Technology, Marketing, or Family and Consumer Sciences). The complete lists of tasks/competencies for CTE courses are considered essential statewide and required of all students (Virginia Department of Education,

2009). The list was taken from the Department of Education website. The tasks/competencies were used to guide the objectives for the lesson plan being created.

The following morning, the pre-service teachers met at a pre-determined location for two hours. Next, they were given the following instructions: (1) select one task or competency for your program area, (2) use any resources, the Internet, and advice from your colleagues and instructors, develop a 50-minute lesson plan for a class of 20 students, (3) during this two-hour block, develop a completed lesson plan using the lesson plan format of your choice. At the end of the two-hour block, lesson plans and associated instructional materials will be submitted for evaluation. Following the activity, the pre-service teachers were allowed to revise their lesson plans and materials, and they submitted a reflective paper that addressed this lesson planning experience.

Results

A variety of themes emerged during data analysis of the reflective papers. Specifically, the pre-service teachers described their initial reaction to the Lesson Plan Blitz process. One participant described that after “receiving the Lesson Plan Blitz assignment, I have to say I was in an utter panic.” Another participant described a similar feeling. “Let me start by saying the Lesson Plan Blitz was rather stressful.” Participants also felt a lack of confidence in developing lesson plans in a time crunch. “I did not feel like I could come in and develop a lesson plan in such a short amount of time.” Even though the process was described as stressful, the Lesson Plan Blitz was ultimately viewed as a positive experience. “The Lesson Plan Blitz is a great example of how hectic our lives might become when we student teach. The lesson learned from this activity is to get organized, prepared, and plan, plan, plan!” Participants also described how this experience will change their approach to lesson planning. “I was in shock how long it took me to develop material...[the Lesson Plan Blitz] was still shorter than my first attempts at lesson planning in July.” Another participant expressed similar reactions. “I plan to use this lesson as a reminder and a motivator to approach lesson planning with more structure and to limit the time I commit to each lesson.”

Future Plans

It is our hope that the Lesson Plan Blitz will assist our pre-service teachers with the demands of curriculum development and lesson planning as they begin their teaching internship. The concept was developed from a need that was observed during teaching internship observations. Our future plans include continuing the use of the Lesson Plan Blitz as the final exam for our Teaching Methods course. This year, it will be necessary to provide more physical space for the group as the classroom did not provide enough room for the pre-service teachers to spread out. Additionally, follow-up interviews can be used to determine the benefit of the Lesson Plan Blitz as it relates to planning during the teaching internship.

Resources Needed

- Laptops and Internet access
- Classroom with appropriate space (depending upon the size of the group)
- Tasks/competencies associated with content areas as determined by the state
- Planning resources (textbooks, workbooks, etc)

References

- Camp, W. G., Broyles, T. W., & Skelton, N. S. (2002). *A national study of the supply and demand for teachers of agricultural education in 1999-2001*. Blacksburg, VA: Virginia Polytechnic Institute and State University.
- Kirby, B. M., & Lebude, A. V. (1998). Induction strategies that work: Keeping agricultural, health and biotechnology career development beginning teachers in the classroom. *Journal of Vocational and Technical Education*, 15(1), 17-27.
- Osborne, E., (Ed.). (2007). *National research agenda, agricultural education and communication: Research priority areas and initiatives*. Gainesville, Florida: American Association for Agricultural Education.
- Schunk, D. (2006). *Learning theories: An educational perspective*. Upper Saddle River, NJ: Pearson Education.
- Virginia Department of Education. (2009). *Career and Technical Education Resource Center*. Retrieved from <http://www.cteresource.org/verso2/search>
- Vygotsky, L. (1978). *Mind in society: The development of higher psychological processes*. Cambridge, MA: Harvard University Press.

Tractor Technician Career Development Event: Classroom Instruction to Career Opportunities

P. Ryan Saucier
Texas State University
212 Agriculture
San Marcos, TX 78666
(512)-245-2130
ryansaucier@txstate.edu

G. Curtis Langley
University of Missouri
207 Agricultural Engineering
Columbia, MO 65211
(573)-882-2126
farmboy_shsu@yahoo.com

William R. Harrell
Sam Houston State University – Retired
Box 2088
Huntsville, TX 77340
(936)-294-1215
billyharrell@att.net

John D. Tummons
University of Missouri
114 Gentry Hall
Columbia, MO 65211
(573)-884-3213
tummonsj@missouri.edu

Tractor Technician Career Development Event: Classroom Instruction to Career Opportunities

Introduction

According to the National Research Agenda for Agricultural Education and Communication (Osborne, 2007), research priority area one finds that one of the ways to improve agricultural education in schools is to examine innovative models that enhance program delivery in agricultural education that better serves young people. This innovative idea poster sought to explain the [STATE] Tractor Technician Career Development Event (CDE) and promote it to other states. The [STATE] FFA Association offers 25 CDE for its members ([STATE] FFA Association, 2010). One of these contests is the Tractor Technician CDE. This contest was designed as an opportunity for students to receive hands-on training which empowers them with highly marketable skills, with the ultimate goal of employment upon graduation ([STATE] FFA Association, 2010). As a result of participation within this contest, students apply mechanical knowledge, critical thinking, and problem-solving skills that also include interaction with industry professionals during the contest. This event is supported by the standardized curriculum and courses set forth by the [STATE] Education Agency, or TEA, (2010) that includes: Mathematical Applications in Agriculture, Food, Natural Resources, Agricultural Power Systems, and Practicum in Agriculture, Food, and Natural Resources. The rules for the contest indicate that a team shall consist of three junior/senior level students who are currently enrolled in a school-based agriculture education course and are a current member of the state of [STATE] FFA Association. Tractor Technician CDE teams can only compete at the state level contest only once and must wear a FFA jacket during the competition ([STATE] FFA Association, 2010).

Program Phases

This contest consists of three parts: a written exam, appraisal of tractor/machinery components, and locating and correcting malfunctions in agricultural tractors ([STATE] FFA Association, 2010). The written exam portion of the contest consists one hundred questions (true/false, multiple choice, etc.) that are based upon state mandated curriculum or [STATE] Essential Knowledge and Skills (TEKS). The appraisal of tractor/machinery components portion of the contest allows participants the opportunity to appraise 20 components or parts from agricultural tractors/machinery. Each component is appraised to determine if the component requires service, replacement, or is in functioning condition. These components can include electrical, power train, engine, cooling, lubrication, hydraulic, and safety system components. The final portion of the contest is designed to test student's knowledge and critical thinking skills. The *de-bugging* portion of the contest challenges students to locate five deliberately placed malfunctions in a diesel fueled tractor. Students are allocated 30 minutes to locate, test, and repair each malfunction and then safely drive the tractor around a pre-designed course ([STATE] FFA Association, 2010). Currently, this contest is offered annually at: 3 invitational contests held across the state, 3 multi-area contests for all 10 FFA areas, and the state contest which is held in conjunction with the [CITY] Livestock Show and Rodeo. The top 3 teams win several thousand dollars of hand tools which are donated by SK Tools.

Results to Date

At the conclusion of the 2009/2010 academic school year, [STATE] school-based agricultural educators, who advised state qualifying Tractor Technician CDE teams, were asked to comment about the contest. Results of some of their comments are listed below:

What are the positive aspects of the Tractor Technician CDE contest?

- “It trains kids to work together as a team using skills they have learned, while preparing them for the work force.”
- “This contest teaches a student how to not only repair a tractor, but to think on his/her feet...”
- “I feel that this is the best contest that the FFA has to offer.”
- “Gives the students a chance to work in real life situations and put into practice a logical thought process to determine what the ‘bugs’ might be.”

What aspects of the Tractor Technician CDE contest would you like to change in the future?

- “It is a great contest where kids can win prizes and scholarships. I would like to see it on a national level.”
- “I think we need keep going just like we have been. I see the need for a computer to help us in the debugging part of the contest as being a problem.”

Future Plans/ Advice to Others

The Tractor Technician CDE contest is an excellent way to connect the knowledge and skills learned in an agricultural mechanics classrooms/laboratories and further apply these learned knowledge and skills to real-world problems. The questions, problems, and situations presented in this contest are based upon actual situations found in the field or at tractor dealerships. The industry contacts that students make through this contest are also invaluable for future employment opportunities.

To implement this CDE in other states, state agricultural education leaders must first make and maintain strong partnerships with tractor manufacturers/dealerships in order to provide long lasting support for this CDE. By selling the point that through manufacturers/dealers support of this CDE, a future line of tractor technicians and support staff can be established. It is also advised that professional development workshops for teachers be planned to explain the facets of this CDE prior to implementation of the contest.

Costs/ Resources Needed

In order for a FFA chapter to participate in this contest, the following supplies are needed: pencils, clipboards, safety glasses for each team member, an ABC fire extinguisher (2.5 lb. minimum), fluid drip pan (16 inch diameter and 2 gallon capacity), hand tools, and test equipment (digital multi-meter, hydraulic line pressure gauge, etc.) Approximate costs of these supplies are \$250 to \$350.

References

Osborne, E. W. (Ed.) (2007). *National research agenda: Agricultural education and communication, 2007-2010*. Gainesville, FL: University of Florida, Department of Agricultural Education and Communication.

[STATE] Education Agency (2010). Chapter 130. [STATE] Essential Knowledge and Skills for Career and Technical Education, Subchapter A. Agriculture, Food, and Natural Resources. Retrieved from: [WEBSITE]

[STATE] FFA Association (2010). Career Development Events. Retrieved from: [WEBSITE]

Using Professional Identity to Enhance Agriculture Teacher Professional Development

Catherine W. Shoulders

Brian E. Myers

PO Box 110540
Gainesville, FL 32611-0540

352-392-0502 x. 238

katewoggs@ufl.edu

bmyers@ufl.edu

Using Professional Identity to Enhance Agriculture Teacher Professional Development Introduction/Need for Innovation

The professional identity that agriculture teachers display socially due to discipline-related contexts can affect their receptiveness and interest in different professional development (PD) events. However, professional identity is often overlooked when designing PD because it is not included in the consensus of proven methods of PD design and delivery (Desimone, 2009). Due to its production-based history melding with recent reform efforts, many agriculture teachers have entered an era of PD that centers around ideals that are inconsistent with those of their professional identity. Ignoring the aspects of agriculture teachers' professional identity can affect teachers' attitudes toward PD, and this may lead to a lack of learning that could have easily been enhanced.

Teacher PD typically follows a progression of delivery based on school-based learning (see North Central Regional Educational Laboratory, n.d.). Critical to teacher learning in traditional PD is the assumption that teachers enter PD willing to learn about and adopt new teaching practices in the classroom. The professional identity shared by agriculture teachers can create barriers to learning through this model, as its root assumption is not necessarily a component of agriculture teachers' professional identity. This poster serves to offer an alternative PD model to teacher educators that eliminates the assumption of teachers' automatic willingness to adopt new teaching practices, thereby reducing learning barriers of agriculture teachers.

Methodology

An alternative PD model, shown in Figure 1, eliminates the assumptions found in traditional PD and addresses the characteristics of agriculture teachers' professional identity.

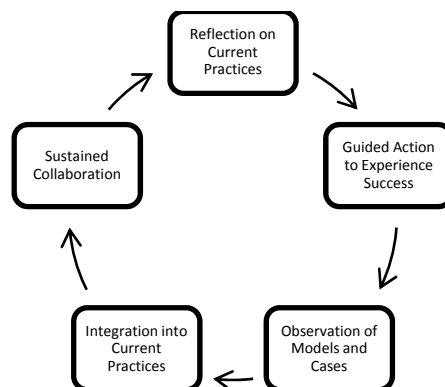

Figure 1. *Proposed Model of Inservice Professional Development for Agricultural Education*

The proposed model begins with a reflection of current teaching practices. In this step, deliverers of PD guide teachers in first discussing positive qualities of current practices and then reporting barriers to using these practices. This step eliminates the assumption that teachers enter PD willing to change their practices. The second step involves the agriculture teacher discovering the benefits of a new practice personally through guided actions facilitated by the PD deliverer. The traditional model of PD assumes that teachers accept the deliverers' word in the success and benefits of a new practice. By allowing the agriculture teacher to experience the benefits of the new practice personally, the teacher can develop an interest in learning more about and implementing the new practice. Teachers then can observe models and cases in a

receptive manner, increasing the likelihood for implementation in the classroom. Facilitators should encourage and guide teachers to integrate new ideas from PD into their current practices, rather than changing classroom practice altogether, as is implied in the traditional model of PD. One of the most significant critiques of “outside” PD is that it does not encourage duration in teacher learning when compared to school-based development. The proposed model, in partnership with NAAE, addresses this issue by creating avenues for sustained collaboration among teachers. This prolonged collaboration between agriculture teachers regarding new innovations allows teachers to further reflect on and alter their practices, allowing for the cycle of PD to continue long after the actual PD session has ended.

Implications

Research regarding PD currently denounces the use of “outside” inservice teacher education, as many of the best practices associated with PD are centered around school-based learning (Desimone, 2009). Agriculture teachers are already placing less reliance on university-based PD in some areas, such as technology education (Kotrlik, Redmann, Harrison, & Handley, 2000). Post-secondary agricultural education not only has a responsibility through extension to service the educational needs of agriculture teachers, but also holds a unique opportunity to do so effectively, as the professional identity of agriculture teachers may allow teachers to be particularly receptive to agriculturally-based PD. Through the context of agriculture and appropriately-designed PD, post-secondary institutions can reclaim a valuable post in teacher education, build more supportive, collaborative relationships with schools and school-based PD, and meet the expectations of the land grant mission.

Advice to Others/Future Plans

The proposed model has been utilized in a state-based PD session designed for agriculture teachers and has experienced great initial success. Its methods of PD will be replicated at a national inservice venue for agriculture teachers, upon which the Sustained Collaboration component of the model will be introduced through the use of NAAE’s Communities of Practice. This poster serves as a vehicle to initiate conversations between post secondary agricultural educators regarding the modification and implementation of the above proposed model in current and upcoming PD events.

Resources Needed

When adapting and implementing the proposed PD model, the most critical resource is time. Agricultural educators must allocate time to better understand the needs and professional identities of the agriculture teachers they serve, as well as to carefully plan PD to account for characteristics of teachers’ professional identity. Because teacher educators are already delivering PD, and because the proposed model is an adaptation of a traditional model of PD, additional expenses incurred due to the alteration in PD design are negligible and at the discretion of the teacher educator.

References

Desimone, L. M. (2009). Improving impact studies of teachers’ professional development: Toward better conceptualizations and measures. *Educational Researcher*, 38(3), p. 181 - 199.

Kotrlik, J. W., Redmann, D. H., Harrison, B. C., & Handley, C. S. (2000). Information technology related professional development needs of Louisiana agriscience teachers. *Journal of Agricultural Education*, 41(1), p. 18-29.

North Central Regional Educational Library. (n.d.). Five phases of professional development. Retrieved from <http://www.ncrel.org/sdrs/areas/issues/educatrs/profdevl/pd2fiph.htm>.

Innovative Idea Poster Submission, 2011 AAAE Conference

**You're Fired! Using Reality Television to Enhance Student Engagement and Motivation
Through Problem-Based Learning**

Christopher T. Stripling, Graduate Assistant
University of Florida
PO Box 110540
Gainesville, FL 32611-0540
352-392-1663
cstripling@ufl.edu

Andrew C. Thoron, Assistant Professor
University of Illinois
137 Bevier Hall, MC 180
905 S. Goodwin
Urbana, IL 61801
(217) 333-1312
thoron@illinois.edu

You're Fired! Using Reality Television to Enhance Student Engagement and Motivation Through Problem-Based Learning

Introduction/Need for Innovation

Research has shown that student engagement and motivation are keys to secondary classroom success (Shernoff, Csikszentmihalyi, Shneider, & Shernoff, 2003). Agricultural education teachers often pride themselves on their ability to engage and motivate students through use of agriculture as a context for core related subject matter and “real-world” applications. However, agricultural educators sometimes find themselves using the same teaching strategies time and time again in an outdated context, thus widening the generation gap between an ever changing student population. Professional development is vital to staying abreast of new teaching strategies or practices that can be used in today’s agricultural classrooms (Roberts & Dyer, 2004). Reflecting upon the need for modernized teaching strategies, the apprentice teaching strategy was developed to tailor an effective teaching method to current realities of student lives.

How it Works/Methodology

The apprentice teaching strategy’s methodology is based on constructivism which theorizes that learners amass meaning from their experiences (Doolittle & Camp, 1999). This strategy focuses on a more specific type of experience known as problem-based learning. Boone (1990) concluded that “the problem solving approach to teaching increases the level of student retention of agricultural knowledge learned during an instructional unit in vocational agriculture” (p. 25). The apprentice teaching strategy uses the concepts of the hit show, *The Apprentice*, to utilize problem-based learning. Problem-based learning can be used to foster student engagement and motivation (Phipps, Osborne, Dyer, & Ball, 2008). This approach helps “students construct their own meaning and understanding of the topic under investigation rather than passively receive information from another source in an already organized form” (Phipps et al., 2008, p. 223). The apprentice teaching strategy uses problem-based learning to achieve desired educational objectives. The teaching strategy takes on many different forms based on subject matter, resources, and educational objectives. The core form is based on the teacher assuming the role of Donald Trump/CEO and the class being divided into small groups (typically 4-6 students) based on assigned tasks specific to the learning outcomes. Each group elects one member to serve as project manager. The project managers report to the CEO and are responsible for helping the groups meet objectives set by the CEO. The small groups compete to achieve the CEO’s facilitated objectives and are assessed based on teamwork, individual contributions, proficiency of assigned task, and a reflective paper. As in the popular show, a boardroom scenario is also used to allow the CEO to question learners on the: who, how, and why of their learning experience. The boardroom can also be used by the CEO to assess the level of understanding achieved by the learners. Educators are encouraged to use variations of the strategy to achieve desired educational objectives.

Results to Date/Implications

The apprentice teaching strategy was used effectively in two contrasting agricultural education programs: a traditional small rural high school in [state] and a non-traditional large suburban

high school in [state]. Qualitative results indicate that students at each high school found the teaching strategy engaging and motivating. The instructor at the small rural high school said, “Students went beyond merely learning information for a test, to living the topical information for use in a real-world problem”. The instructor at the large suburban high school reported that his “students were enthusiastic and sought new tasks from the CEO at the completion of the assignment”. Both educators felt that the teaching strategy helped learners connect the state standards of the educational unit to their real world experiences. The educators also felt that this strategy encouraged the students to become self regulated learners. Based on the positive feedback from the students and the teachers it is anticipated that other agricultural educators may wish to use the apprentice teaching strategy. The presentation of this poster is one means of sharing this innovative idea.

Advice to Others

Problem-based learning activities may present difficulty to gauge the amount of time necessary to accomplish desired educational objectives. One agricultural educator gave the following suggestion: “Be willing to be flexible and allow for more instructional time as needed for more complex problems”. The time needed to employ the teaching strategy will vary depending on the educational objectives. For example, the instructor at the small rural high school developed an eight-week unit on marketing and business management using the strategy, whereas the instructor at the large suburban high school used the strategy as a short four-day unit on cells. The apprentice teaching strategy also requires the educator to become comfortable with being a facilitator of learning that encourages learner-learner interactions. As students progress through their real world experience they may encounter problems that are beyond the expertise of the educator. It is recommended that the educator be prepared to direct students toward sources of information. It is also suggested that rubrics be designed for assessment and that the rubrics hold individuals accountable for their contributions to the group.

Costs/Resources Needed

Costs and resources needed will vary depending on the school, subject matter, and educational objectives. This was evident at the two schools in which the teaching strategy was employed. The small rural high school had access to a seven-acre land lab and a company that was willing to donate supplies. Students at the suburban high school did not have access to a land lab or support from a local business. These students had to utilize available class materials and were given a theoretical problem to solve that was of a real-world context.

References

- Boone, H. N. (1990). Effect of level of problem solving approach to teaching on student achievement and retention. *Journal of Agricultural Education*, 31(1), pp. 18-26.
- Doolittle, P. E., & Camp, W. G. (1999). Constructivism: The career and technical education perspective. *Journal of Vocational and Technical Education*, 16(1). Retrieved from <http://scholar.lib.vt.edu/ejournals/JVTE/v16n1/doolittle.html>

- Phipps, L. J., Osborne, E. W., Dyer, J. E., & Ball, A. (2008). *Handbook on agricultural education in public schools* (6th ed.). Clifton Park, NY: Thomson Delmar Learning.
- Roberts, T. G., & Dyer, J. E. (2004). In-service needs of traditionally and alternatively certified agriculture teachers. *Journal of Agricultural Education*, 45(4), 57-70. doi: 10.5032/jae.2004.04057
- Shernoff, D. J., Csikszentmihalyi, M., Shneider, B., & Shernoff, E. S. (2003). Student engagement in high school classrooms from the perspective of flow theory. *School Psychology Quarterly*, 18, 158-176. doi: 10.1521/scpq.18.2.158.21860

**2011 SOUTHERN REGION CONFERENCE
OF THE
AMERICAN ASSOCIATION FOR AGRICULTURAL EDUCATION**

Research Paper Discussant Comments

10:30 – 12:00 p.m. Concurrent Research Session I

Session A: Agricultural Education: Improving Practice.....AmBankRoom 225D/E

**Relationships between Agriculture Teaching Efficacy and Decision to Teach Among
Agricultural Education Majors**

Discussant Remarks

Dr. Barbara M. Kirby, NC State University

This study represents a cooperative research effort between faculty members and their students at the University of Georgia and Middle Tennessee State. Their study proposed to identify relationships between agriculture teaching self-efficacy and decision to teach among undergraduate agricultural education majors who had not completed their student teaching internship. Numerous studies in agricultural education and career exploration substantiate that there are relationship between what an individual likes to do, what they believes they can do and their career choice. This is an important study to help us identify factors that may influence a student’s decision to teach thus addressing our national agriculture teacher shortage crisis.

The study is well written and grounded in a sound theoretical framework. The authors draw upon previous research where teacher self-efficacy has been directly correlated with student motivation, classroom management and teacher evaluations. The study is grounded in Social Cognitive Theory and Expectancy Theory to explain student career choice. The researchers follow appropriate research procedures and communicate the findings in a concise, meaningful way. Particular attention is given to explaining the validity and reliability of the instrumentation, data collection processes and data analysis. This study contributes to a rich body of knowledge that should help teacher educators further understand how the learning experiences we provide may influence teacher efficacy and eventually the teaching career choice.

The study was designed so that teaching self-efficacy was studied through the domains of classroom, FFA, and SAE. Obviously these are the skills our teachers should possess. It is interesting that self-efficacy was highest among the SAE domain, followed by FFA and classroom domains respectively. Could the fact that nearly 80% of the study population having ag related jobs explain why self-efficacy was highest in the SAE domain?

Most participants planned to teach if the perfect opportunity presented itself. What is the “perfect opportunity?” Only 13 of the 55 or slightly over 23% were “unsure or seeking other employment. Given the demands of the job, is this a reasonable percentage? What can we do to increase percentage of those who want to teach and/or go on to graduate school? Is graduate school primarily to earn a master degree in agricultural education? How is the delay to teach impacting our programs? Shouldn’t it concern us that there was no significant correlation between classroom self-efficacy and the decision to teach? We should evaluate our instructional programs and evaluate how we prepare students in managing student behavior, working with special needs students, and evaluating learning in addition to teaching greenhouse management and ag mechanics. There was only a moderate relationship between FFA teaching efficacy and

decision as well as SAE teaching efficacy and decision to teach. There was no relationship between agricultural education experiences and decision to teach. We know that many of our pre-service students now come from non-farm backgrounds. They were not FFA members. They did not have SAE experiences. I concur with the authors that these findings lead us to further study that may have implications for recruitment and degree program length. A very good paper.

Stress Levels of Agricultural Science Student Teachers and Cooperating Teachers

Discussant Remarks

Dr. Barbara M. Kirby, North Carolina State University

For this study, stress is defined as “a condition or feeling experienced when a person perceives that demands exceed the personal and social resources the individual is able to mobilize” and/or “...physical, mental, or emotional strain or tension” (<http://www.stress.org>). That pretty much describes the phenomenon that has the potential to drive a person from the job or in the case of the student teacher, from ever considering the job. The authors are to be commended for designing a study that addresses the Agricultural Education in Schools research priority area focusing on RPA 4: Prepare and provide an abundance of fully qualified and highly motivated agricultural educator at all levels. This study helps us understand stress levels and stressors experienced by both student teachers and cooperating teachers during the field practicum. Knowing something about when the stressors occur and the severity of the stressors should help teacher educators better prepare student teachers and cooperating teachers in coping with the challenging times.

The study is well written; grounded in a sound theoretical framework; follows appropriate research procedures and communicates the findings in a concise, meaningful way. Particular attention is given to explaining the validity and reliability of the instrument, data collection processes and data analysis. This study contributes to a rich body of knowledge including teacher burnout, student and cooperating teacher relations, stressor frequencies and perceived stress intensity.

It was interesting to note that student teachers and cooperating teachers experienced various level of stress at different times during the semester. Job stress severity declined among student teachers as the semester progressed. Perhaps they were experiencing more success and an increase in self confidence as the semester progressed. However, stress severity increased in cooperating teachers at the midpoint of the semester – was this the point they were giving student teachers more independence in their classroom? Did managing the instructional program and mentoring the student teacher in major activities like career development events, FFA banquets, fund raising projects, etc. peak their stress levels? After several hectic weeks, teachers were able to relax with the “end was in sight” toward the end of the semester. It makes sense that job stress frequency increased in student teachers throughout the semester. Their work load increased and the “real” experiences presented themselves. Job stress frequency declined in cooperating teachers at mid-semester then a slight increase at the end. Wonder why? What events may have influenced these levels? Are they facing competency tests? Have the students “suffered because of the student teacher? Was the instructional program taught as it should have been taught?

Cooperating teachers usually declare that they work harder during the semesters they have student teachers. Those without student teachers declare this as vacation time for the cooperating teacher. I would be interested in learning more about how student teachers contribute to teacher stress and job pressure and what practices professionals can put in place to better manage their stress levels and job pressure of both the cooperating teacher and the student teacher. I commended the researchers on conducting an excellent study.

The Relationship between Cooperating Teachers' Leadership Style and Student Teachers' Satisfaction Level
Discussant Remarks

Dr. Barbara M. Kirby, North Carolina State University

The purposes of this study were to describe characteristics of the student teachers, their level of satisfaction with their cooperating teaching, the cooperating teachers preferred leadership style and the relationship between the cooperating teacher's leadership style and the student teacher's level of satisfaction. This study is important. As a profession, we must find answers through our research to address the agricultural education teacher shortage. The relationship between leadership style of the cooperating teacher and student teachers' satisfaction level may provide insight for us as we address a critical need identified in our *Research Agenda for Agricultural Education & Communications*. Specifically that of "preparing and providing an abundance of fully qualified and highly motivated agriscience educators"

The study is well written. The paper draws upon a rich review of pertinent research studies focused on teacher shortage, teacher satisfaction, leadership style and personality types. The authors concluded from their review that cooperating teacher leadership style rather than personality type should be examined further as a factor for satisfaction of student teachers. Blanchard's Theory of Situational Leadership grounds the study in a sound theoretical framework. The work of Greiman (2002) and Kitchel (2005) provided the basis for measuring student teacher satisfaction. The cooperating teacher is a mentor so it makes sense to draw upon models that explain important practices of mentors given the developmental stage of the mentee. The authors use appropriate research procedures and communicate the findings in a concise, meaningful way. Particular attention is given to explaining the use of existing instrumentation and the appropriateness of the instrumentation for the study population.

The majority of cooperating teachers preferred the supporting leadership style followed by coaching style. It is interesting that while 3 individuals perceived themselves as directing styles, none identified as delegating. Satisfaction among student teachers with "supporting" leadership style cooperating teachers implies that we need to pay closer attention in matching students to teacher leadership styles not just program quality or finding a good role model. How well do we identify our student teachers' developmental levels so we can match them to appropriate teachers? Mentoring is often described as moving a person from a lower developmental stage to a higher level where the mentee becomes self directed. How can we help our student teachers move to a level requiring minimal direction? How do we prepare cooperating teachers to practice acceptance and counseling behaviors in order to move student teachers to the next developmental level? What tools do we provide for those cooperating teachers who are assigned the student teacher at the lowest developmental level? Keep in mind that student teachers who do not reach a self directed developmental level will begin a teaching career with high levels of need for direction and support. If they are not part of a first year mentoring program designed to meet that need, it is likely that their satisfaction levels will crash as new teachers. What do we need to do to strengthen the relationship between our student teaching programs and first year programs based on the findings of this study?

Congratulations on a well done study that contributes to a critical need in our profession.

**Developing and Testing an Integrated Global Curriculum for an Introductory High School
Agricultural Education Class
Discussant Remarks**

Dr. Barbara M. Kirby, North Carolina State University

The authors are quite correct when they say that “the United States and the agricultural industry are no longer isolated as they once were. Both are now interdependent with the rest of the world.” Consider these North Carolina statistics. The state ranks 11th in international exports. The total value of Agriculture exports, not including lumber exports, exceeded \$2.8 billion in 2009. This is a 70% increase since 2004. Agricultural exports help boost farm prices and income, while supporting about 35,907 jobs both on the farm and off the farm in food processing, storage, and transportation. If agricultural students are going to be successful in agriculture careers, they must understand the dynamics of international agriculture – the players, the politics, the policies and the impacts.

In their literature review, the authors examined previous research about adolescent attitude development and in particular attitudes toward international agriculture. Early adolescence is a critical time for shaping an international perspective. This study is important because there is little empirical evidence about high school international programs, instruction or the impact.

The purpose, objectives and procedures were adequately described. Specifics about instrumentation reliability and validity would assist the reader in interpreting the results. Others who wish to duplicate the study would benefit as well. The authors acknowledge the limitations of the study. How typical was the freshman rural agriculture class in comparison to other high school freshman classes in agriculture in Florida? Additional research, using a more representative sample would strengthen the study.

The author created a four lesson curricula based on the themes of Introduction to Latin America, Sustainability, Agroforestry, and Tropical Crops based on a personal experience study abroad course in Costa Rica. What a great idea to bring a experiential perspective to this research. It is amazing how little students know about international agriculture. Even with limited instruction, it is possible to increase awareness of international agriculture production and practices. Students had mainly neutral views on international agriculture and did not feel prepared to enter into a globalized workforce. How can we use technology to provide students a “safe” international experience? What are some ways for us to include more global elements of agriculture into current curriculum? How do we convince students to prepare to enter a global workforce upon graduation?

Hopefully the authors will continue to investigate opportunities for high school international agriculture experiences and build upon the findings of this study. The curriculum developed for this study should be of interest to others in our profession as we engaged high school level students in international agriculture experiences.

Discussant Comments by Nicole Stedman
The Interactions of Instructional Efficacy, Motivational Orientations, and Adult Characteristics on Tenure in the Florida Extension Master Gardener Program

Having spent a few years researching the role of volunteerism in Florida's Extension programs, there is an appreciation for the importance and value of identifying the significant factors related to tenure. While the Master Gardener Program is unique not only its hour requirement for service, it provides volunteers with a long term way to give back to the organization. However, increasingly difficult times in budgets and program expenditures results in a heightened importance in understanding the return on investment that is made through these programs.

The author(s) did an excellent job of identifying an appropriate theoretical framework for which the research was guided. Bandura is largely recognized for his work in self-efficacy, but Houle's may not be as widely known for his contributions to adult learning theory. This combination showed to be appropriate for the intent of the study. The research was designed with specific objectives to elicit information about the larger research question.

Methods were clear and the researcher(s) are commended for their documentation of the specific statistics (Poisson regression) used in the study. It was refreshing to see a different perspective applied to this type of data analysis. As a result, findings were clear and reported well.

All things considered the value of the study comes in the implications and recommendations portion of the paper. In these two sections, the connections are made to previous literature, but the reader has a much better sense and understanding of why the findings were important. By understanding that age is a key factor in MG tenure is extremely valuable when designing recruitment messages and that the more likely a volunteer is to have a heightened sense of self-efficacy related to instruction the greater tenure they will gain. These two factors provide such a strong direction for practitioners when designing programs related to MG volunteers.

However, the challenge becomes taking recommendations beyond the standard of what could be done, or what practitioners should do to how things should be done. This is so important for translating the value of research to those who are most likely to put into practice what is found. For example, how do we market programs to a homemakers or retirees, what strategies work? With that, the research community needs to be strategic in identifying recommendations that are specific and clear and that promote ideas of how to integrate these wonderful ideas into programming.

Discussant Comments by Nicole Stedman
A Balancing Act: Investigating Graduate Student and Advisor Relationships in
Agricultural Leadership, Education, Extension and Communication

This study has certainly been conducted at a time when there is an increased emphasis on the role of graduate education in higher education institutions. Efforts have largely been focused on raising standards of graduate education, including general perceptions about the satisfaction that students have about their programs. At many institutions this is a direct reflection on the research brand identified by the department.

The author(s) did an excellent job of eliciting an appropriate model whereby to guide the study. The problem was specific and focused and appropriately addressed through literature. Use of the mentoring model, Mentoring-Empowered Model, did make the assumption that the advisor role is synonymous with mentorship. The research purpose and objectives provided the direction for the study and sought to address the proposed research problem.

The one component of the research methodology that was difficult to grasp was the low overall response rate. It is clear why the researcher(s) utilized contact through the graduate coordinator, but it must be discussed as a limitation without direct access to the sample. This could also allude to some bias in the overall study in that those who participated may have anticipated more favorable results on behalf of their graduate students. This may have been remedied by comparing respondents and non-respondents versus just early and late.

With being a descriptive study the findings were clearly presented and thoroughly represented in tables. For the most part, the findings indicate that yes, as a discipline we are adequately serving our graduate student population. The gain comes in understanding how we are doing a good job. The combined conclusions, recommendations, and implications section purports that this is more of a challenge – how can units continue doing a good job?

One particular area would have been interesting and that would have been a breakdown by program area. While it is recognized that a department is a singular unit, findings provided by specialization may have made for a richer description of the objectives.

The challenge does come in finding ways to be strategically more innovative when it comes to advising graduate students. At a time where funding within a higher education institution could be tied to graduate program success, this seems like an appropriate and timely area of focus.

Discussant Comments by Nicole Stedman
Stages of Concern Profiles of Agricultural Technical School Teachers in Egypt
for Implementing Student Internships

As opportunities for international development and aid increase it is important that we understand the climate of what works and does not. In education that values comes in being able to address issues that pertinent to creating a quality learning environment for students. Through identifying instructors concerns or hesitations about specific pedagogical approaches program providers are able to much more efficient in their delivery.

The author(s) set forth a strong argument for addressing the perceptions of ATS teachers about experiential learning methods, specifically student internships. By identifying internships as an innovation the researcher(s) were able to give parameter to the study. The research purpose and objectives were clear and consistent with the research problem identified by the author(s). One aspect not addressed by the researcher(s), but would have been interesting is how Egyptians deal with change generally. Perceptions of change and innovation could have potentially impacted the overall findings of the study.

The methods and data analysis procedures used were appropriate and designed to yield responses to the research questions. Through the translation process instrumentation was adapted to the specific target population. Findings were described well and the use of graphs allowed for a visual interpretation of the results.

Through the recommendations and implications it is seen that Egyptian ATS teachers are much like those in the states, in that there must be opportunities to interact with an innovation prior to reaching a certain level of comfort. As with other literature discussing the pros and cons of experientially-designed instructional strategies, this research identifies very similar concerns. The hesitation or concern in control and classroom management; as an instructor it is easy to understand the concern that releasing students upon a community may not elicit favorable opinions. It was also good to see the confirmation that regardless of teaching experience, a new innovation is a new innovation and has to go through all stages of concern.

One area that the paper could have been strengthened is in the practical recommendations component. The author(s) did an excellent job of identifying areas of continued research, but fell short in providing practically minded ideas for addressing these findings. One potential area, which could be explored through research, but would also have a practical orientation, is the use of peer mentors. What value could a mentor to discuss and share his/her experiences about experiential strategies, like student internships, add to promoting others through the Stages of Concern?

Overall this was a great paper, which demonstrated the connection between domestic and international teachers. As more opportunities become available it will become more of necessity to demonstrate that the time honored approaches used here in the states are appropriate and relevant across borders.

Discussant Comments by Nicole Stedman
Corn Clubs: A Historical Inquiry

First off, the author(s) are commended for providing a detail account of a historically relevant piece of agricultural education. Many of the traditions in programming are lost over time and it is refreshing to see a unique take on providing an account of corn clubs.

The author(s) did an excellent job of accounting for the role, importance, and value that this research would provide. Theoretically there is relevance in ensuring an agriculturally literate society, beginning within the profession. Methods are documented and appropriately discussed for historical inquiry.

The rich descriptions included in the results of this paper are wonderful. A lesson learned for all readers. The organization is clear, linear, and easily interpreted. By providing such an in-depth examination and then making the connection between the SAE in agricultural education today, the author(s) further document the value-laden experiences provided to students through agriculture.

One area which could have been strengthened would have been a separate recommendations section. The author(s) spend ample time sharing conclusions and implications, including recommendations; however some of the great ideas for reinvigorating this idea back into schools and communities get lost. It would be advantageous to also promote other historical areas of the profession which could be documented in this manner, as well as other research needs to further support the development of these concepts.

**A Non-Traditional Route to Teacher Certification:
Testimonies from Four Teacher Aspirants in Agricultural Education**

Overview

The purpose of this qualitative, descriptive study was to assess the factors that led non-traditional students (those who did not take agricultural education classes in high school) to the agricultural education major per the PE (Personal Environment) fit. The study consisted of four students who and were at varying stages of their academic preparation. Findings of the study indicated that these participants were motivated to pursue an agricultural education teaching degree because of their passion for agriculture and youth and affinity for people and the job. Parents and friends were the biggest influences on these individuals' decisions. Their greatest perceived strengths were their content knowledge, leadership skills, and ability to preserve, and their greatest perceived limitation was their lack of experience in a secondary agricultural education program.

Rationale

What inspires students to teach agriculture? Pre-service teachers often indicate that a former teacher was their biggest influence in choosing to become a professional educator. However, what about students desiring to be agricultural educators who did not participate in agricultural education or FFA at the secondary level? What influences and motivates them to become agricultural education teachers? Due to a shortage of teachers in several states, it is important to be able to recruit additional students into the profession.

Research Methods, Reliability and Validity

This qualitative , descriptive study consisted of open-ended questions in face-to-face interviews with four “non-traditional” pre-service agricultural education majors. The qualitative, descriptive method of data collection was appropriate because of the small sample size of pre-service teachers who participated in the study. The researchers served as the instruments for the study. Each interview consisted of a highly structured, 21-item protocol that was developed by the researchers based on the PE fit theory of career choice. To establish credibility of the protocol, the researchers asked two professor in Ag Ed to asses the questions for completeness and consistency in conjunction with the study’s purpose. The study employed a purposive sampling technique. Once data were transcribed verbatim, member checks were conducted to establish credibility. For dependability, the researchers each developed an audit trail based upon their analysis of the data. Each researcher documented the transcriptions for dependability and credibility.

Service to the Profession

Although the paper reported the 13 per cent of the pre-service agricultural education students never had agricultural education classes in high school, this reviewer with over 30 years of experience as a teacher educator in agricultural education has experienced approximately 33 percent of his students never having agricultural education in high school. Therefore, we need to know what they are thinking. This study did an excellent of telling their stories and

understanding their thought patterns. Also, developing an understanding of the PE placement fit, will help pre-service teachers understand their “fit” early in their academic careers which could have implications for recruitment and retention efforts of teachers, as well as teacher quality.

Analysis of North Carolina Public School Superintendents' Awareness of Biotechnology and the Future of Biotechnology Education

Overview

The purpose of this study was to gauge the perception of North Carolina public school superintendents regarding Biotechnology and its future in the North Carolina public school curriculum. It was found that respondents overall were knowledgeable about biotechnology and saw it as beneficial in general health, nutrition, and environmental quality. With regard to the barriers of biotechnology respondents indicated that religious that religious concerns, lack of education, ethical issues, access, labeling, and legislation were barriers. As for the future of biotechnology education respondents indicated that universities and industry would be important to its future, but were undecided if public support existed with respect to its implementation.

Rationale

Biotechnology firms many times are in need of more highly skilled workers than are available, particularly in training programs within their local region. In order to ensure America's continued economic growth and national security advances in science and engineering, particularly in biotechnology are essential, and North Carolina has the third largest concentration of biotechnology in the United States. The future viability of North Carolina's biotechnology industry greatly depends upon the development of essential knowledge, skills, and dispositions in regard to biotechnology in the public school students. The success of a biotechnology course depends upon the support of superintendents. Without their support, initiatives such as biotechnology are not feasible.

Research Methods, Reliability, and Validity

The population for this descriptive study consisted of superintendents who had at least one secondary agricultural education program. A panel of experts at the researchers' university reviewed the survey instrument for content validity. A pilot test of the study was conducted in a different state. To establish internal consistency reliability, the instrument was analyzed using the software package SPSS. Chronbach's Alpha Coefficients for the study were conducted on the four sections and all were deemed to be reliable. After three collection rounds were completed, the response rate was 46%.

Service to the Profession

The authors have provided the profession with a model to follow when a State wants to adopt a new course with a reliable and valid instrument. The knowledge that a person possesses regarding a particular topic in turn influences their attitude and behavior regarding that subject matter. A person's initial attitude towards a subject serves as an anchor with regard to any communication regarding the subject.

How Teacher Self-Efficacy and Job Satisfaction Changed During The Entry-Year of Employment of Agriculture Teachers: A Comparison of Certification Types.

Overview

One of the big issues in the profession is the comparison between traditional certified and alternative certified teachers. This research has tackled the problem "head on." The purpose of this descriptive-correlation study was to assess the level of teachers-self-efficacy and job satisfaction of first-year secondary agricultural education teachers at the beginning and end of their entry-year in the profession. This study found that both groups of first-year teachers increased their level of teacher-self-efficacy through the year with alternatively certified teachers receiving a higher score. However, alternative certified teachers decreased in job satisfaction. Traditionally certified teachers were scored higher and received better student achievement scores than alternative certified teachers. Also, traditionally certified teachers had higher retention rates than alternative certified teachers. It could be assumed that traditionally certified teacher would have higher levels of teacher-self-efficacy when compared to the alternative certified teachers. However, due to pre-service education and traditional certified teacher are more critical of their performance, because they know what is expected of them, maybe the alternative certified teachers "don't know what they didn't know!"

Rationale

The National Research Agenda for Agriculture Education and Communication identified a priority area to "prepare and provide an abundance of fully qualified and highly motivated agriscience educators at all level. This priority area was targeted, in part, because of the teacher shortage in agricultural education. It is far more effective to retain teachers than hire them. However, the effect and credibility of alternative certified teachers has been questioned due to the fact they have not received formal preparation in college including student teaching. Therefore, it could be implied that teacher's self-efficacy may be related to their level of job satisfaction, thus increasing teacher retention

Research Methods, Reliability, and Validity

Appropriate research methods were used for the descriptive correlational study. Independent t-test were calculated for objective four and a Chi-square analysis was conducted for objective five. The analysis of objectives four and five used inferential statistic to compare the performance and employment intention of the two certification types. Face and content validity for job satisfaction was established through a panel of experts. Reliability estimates of the instrument were established through previous research with Ohio secondary agricultural education teachers.

Service to the Profession

This study shows that teacher educators are doing a good job of preparing agricultural education teachers per the outcome of several areas of the study. Plus, if alternative certified teachers receive similar in-service training, student achievement can be increased as well as teacher retention.

Entry-level Technical Skills That Teachers Expected Students To Learn Through Participation in the Supervised Agricultural Component of Secondary Agricultural Education (SAE): A Modified Delphi Study

Overview

Supervised experiences are designed to provide opportunities for hands-on learning of skills and practices that lead to successful growth and future employment in an agricultural career. However, it was reported that 91% of students indicated that they did not have an SAE showing that the SAE component of agricultural education is losing groups in many agricultural education program.

Rationale

SAE is the part of agricultural education that allows students to practice in a work setting (placement) or an entrepreneurial (ownership) environment what they have learned in the classroom or laboratory. SAE is one of the critical components of Secondary Agricultural Education “three circle” model of program delivery. Productive SAEs enhance acceptance of responsibility, development of self confidence, opportunity to learn independently, development of independence, and learning to work with others. Therefore the purpose of the study was to describe the perception of a select group of agricultural teachers regarding the entry-level technical skills they expected students to learn through their participation in SAEs.

Research Methods, Reliability, and Validity

The study was descriptive using the Delphi technique. The authors are to be commended for their scholarly use of the Delphi in soliciting real-world knowledge from experts. The authors are to be commended for the following to enhance the validity of their study:

- (1) Purposeful sampling was used to select members for the study’s expert panel.
- (2) At least 15 members were used, which is representative of the expert community
- (3) To ensure statewide representation, service on the State’s Board of Directors served as the criteria for selection as panelist because the success of the Delphi relies on the informed opinion of recognized experts.
- (4) Agricultural education faculty member established content and face validity for the initial instrument for the students.
- (5) To ensure a 100% response rate, electronic “reminder” messages were sent to panelist approximately one week prior to due date.

One first round resulted in 555 technical skills. After refining and going through two more rounds, 161 technical skills were identified. The profession is appreciative of this test. Each of the skills were matched with one of the seven career cluster areas.

Service to the Profession

The research is very useful to the profession. The only suggestion for improvement is to include all 161 technical skills identified rather than the 96 listed. The list would be

valuable to the profession for pre-service and in-service classes. However, It is realized that space is a limiting factor.

8:30 – 10:00 a.m. Concurrent Research Session II

Session D: Agricultural CommunicationsAmBankRoom 225A/B

Impact of Selected Factors on Perceived Efficacy of Twitter Use by Agricultural Communicators

This examination of the use of Twitter by agricultural communications professionals represents another good piece of research helping describe the current state of how social media is being adopted and used in our discipline. The attempt to explain factors affecting efficacy is especially interesting and adds to the body of knowledge promoting social media use in the agricultural communications discipline. I have some reservations related to the observation that use of advanced functions of Twitter (employing auxiliary means) correlated with higher efficacy. The correlation makes sense, but the implication that there is a one-way causal relationship may not be accurate. Couldn't it be true that users' efficacy, higher because of their younger age and higher frequency of use, motivates them to use auxiliary means more often? Regardless, the discussion of what affects user efficacy is important and should continue, especially as it becomes clearer that social media is more than just a passing fad. It will continue to be important for agricultural communications researchers to discuss social media use from a theoretical standpoint, and models like the one described in this paper—oversimplified as it may be—will be useful in helping to clarify this discussion.

Discussant Remarks—Jefferson D. Miller, Associate Professor, Agricultural Communications, University of Arkansas

Agricultural Communications Training Needs Among Oklahoma Agricultural Educators

This analysis of high school agricultural educators' needs related to their ability to teach agricultural communications has important implications for the discipline of agricultural communications. For university-level academic programs to grow and meet the expressed need for more communications professionals in the agriculture industry, students must be exposed to agricultural communications skills and careers as high school students. As the conceptual framework employed in this study highlights, teachers' previous experience with agricultural communications will play a very important role in the outcomes of their teaching efforts later in their careers. Examining teachers' "presage variables" through focus groups is an excellent idea and should serve as a model for future studies in other states and nationally. The most important finding in this paper appears to be that agricultural educators gain most of their formal training about agricultural communications from ONE introductory level service course in college, implicating the significance of this course as a part of pre-service teacher preparation. Even having taken this course in college, many teachers fail to understand that agricultural communications skills go well beyond public speaking. Understanding how teachers view the discipline may indicate a direction for further training materials for agriculture teachers as well as for improving the agricultural communications service courses that many pre-service teachers take in college.

Comparisons of Agriculture Instructor and Student Perceptions of Social Media in Education

This study is important to the discipline of agricultural communications because it represents an effort to establish a benchmark regarding the use of social media in agricultural education at the college level. The findings are surprising, but they may provide some perspective on the generation gap between faculty and students regarding how social media is viewed. Personally, I have observed that the newest generation of college students views social media as a tool for social affiliation only. Many students actually resent efforts to overtly use social media as an educational tool. The Expectancy Violation theory works well to describe what I have observed, and it also helps explain the findings of this study. However, I suspect that over time students will soften on this stance. As more instructors choose to use online forums and video-sharing sites, and as they expand into even more social media forms, students are likely to catch on. However, as the authors note, instructors who push the limits of social media use should proceed with caution. They could easily provoke students to revolt against educational efforts when they feel that their social media freedoms have been encroached upon by education.

Information and Communication Technology Tasks Required in Undergraduate Agriculture Courses

This description of how information and communication technology (ICT) skills are used in undergraduate agriculture courses shines a spotlight on what I perceive is an important problem in many college courses today—that many faculty fail to be promoters of communications technology. It is disturbing to me that more than 20% of faculty report not requiring the use of internet technology in their course and that 42% do not require word processing. Further, 47% do not require lab or project reports to be typed in word processing software, and 16% do not require students to use e-mail? And only moderate increases are projected? It's just hard to believe that this many faculty are not incorporating basic communications technologies into their courses. The implications of this study are understated. While an average of 8 ICT tasks were assigned per class in a semester, eight isn't enough, and something must be done. While the focus of this study was on classes that require the use of ICT skills, another interesting question would be how many faculty actually *teach* these skills as a part of their curriculum. If the answer is "not many," then the source of the problem may be identified. The concept of "ICT intensive" courses is a start, but we will need to do even more to make headway with this issue.

Enhancing Collaboration among Math and Career and Technical Education Teachers: Is Technology the Answer?

Discussant Remarks- Ryan Anderson, Ph.D. Iowa State University

The need for increased student achievement in secondary mathematics has been well documented over the past two decades. Career and Technical Education has also been identified as an excellent contextual avenue to reinforce mathematics. Prior studies regarding academic integration amongst CTE have resulted in a couple of major barriers; one being the teachers ability towards the content area, the second is their attitude toward that content area and finally the third involves the concrete walls and doors between the CTE classrooms and academic classrooms. Parr has previously point out that it is important to build a bridge between the agricultural context and the academic content. One of the important steps in building that bridge is developing a solid footing. In this case that solid footing is communication.

The researchers indicated that the participants were attending a professional development workshop, but did not elaborate on the workshop. Was Math-in-CTE one of the areas highlighted in the workshop? Was the workshop focused on technology? If this workshop did focus on one of the two above, did you distribute the instrument prior to or after the workshop? Did the workshop have any effect on the findings? Could you expand on the determining reliability and validity of the instrument? Did you happen to investigate the relationship between the CTE and math teacher as a possible barrier as well?

Overall, I think this study provides more questions than it provides us with answers. Did the researchers look to see if the participants were currently using any of the technology proposed in RQ #3? What are their attitudes toward those technological items? Was there a comparison between CTE teachers and Academics teachers to see if there were any trends? As I read the research questions and then look at the participants are you only reporting what you found from the 15 CTE teachers or is at all 44 participants? Is that enough to draw the conclusions that you have drawn? When we look at the conclusions how do they link back to the literature review? There was only one attempt to connect the two.

I applaud the effort of the researchers for looking at an important area within our school system. However, does this study really provide the insight that the researchers are suggesting from the title of this paper? Is technology the answer? If so, is there a specific technology that seems to be supported more than the others?

Animation: Friend or Foe in Today's Classrooms?

Discussant Remarks- Ryan Anderson, Ph.D. Iowa State University

Utilizing technology in the classroom has long been touted as highly important in our profession. So much so that in numerous teacher education certification programs require students to enroll in at least one technology related class. This study provides us with some evidence that technology doesn't always improve student learning which is intriguing to me. As an instructor of the topics covered in this study I would have thought animation would have a major impact on four-cycle theory. However, I have noticed informal trends from the students acknowledging that they know as much, or more than the instructors regarding the content covered in technology classes in many cases.

Overall, I thought the design of this study was solid. I do agree with the researchers in suggesting a larger sample size. Additionally, the researchers should consider expanding on the two students who were identified as outliers and the process behind that. There were a couple of other questions that I thought were worth considering. First off, was there any consideration to running a second post test at the mid-term or final exam time to see if one group retained the information longer? Secondly, If technology does not have a major impact on student learning, does that allow us the ammunition needed to drop that class and add an additional course that has more impact on student learning?

Teachers' Use of Interactive Whiteboards in the Secondary Agricultural Education Classroom: Measures of Self-efficacy, Outcome Expectations, Interest and Selected Relationships

Discussant Remarks- Ryan Anderson, Ph.D. Iowa State University

The utilization of technology in the agricultural education classroom is an important area of research within our organization. I fully support the notion that there is limited research on the utilization, levels of adoption and outcomes associated with technology and more specifically whiteboards. However, a quick search on Google scholar highlights several studies that were withheld from this literature review that I would find pertinent to this study. We must work as a profession to continue to connect ourselves more closely with the education field as a whole, we can learn just as much from our other colleagues in education as we can from ourselves. What does the literature suggest when handling invalid email addresses when using a random sample? When you look at the demographics in this study are they an accurate representation of the demographics in Oklahoma? It was unclear if the 90% male or age was an accurate representation. When asking if they have access to a whiteboard, did you ask if they used them as well. The question as it stands may lead us to a false sense of integration. One of our student teachers back on campus recently for a meeting and one of them noted that the entire school had just purchased interactive whiteboards and no one knew how to use them until our student teacher did a workshop for the high school, yet they had access to them. You concluded that a majority of the teachers had taught between 1 and 15 years, that seems to be a fairly wide spread amount.

When you look at this study, I can't help but wonder how the diffusions of innovation could have been incorporated into this study. I also wonder if the older teachers view IWB's as just another technological fad that will soon lose its luster, thus justifying the need to stick with their tried and true methods. As you analyzed the results of this study, I wondered if you compared these findings to other technology integrated by agricultural educators and noticed any trends. I would have recommended to research student learning outcomes of using IWB's and traditional classroom methods. Overall, this is a good introductory piece of research that should lead us into deeper analysis of the role of technology on student learning in the digital native era.

Florida Preservice Agricultural Education Teachers' Mathematics Ability and Efficacy
Discussant Remarks- Ryan Anderson, Ph.D. Iowa State University

As the demand continues to grow to increase academic success of students in secondary schools, having highly qualified teachers to deliver that content is essential. In this study, the researchers investigate pre-service teachers' mathematics problem solving abilities. I thought that the authors' needed to provide a better picture of the participants by answering the following questions:

- You mentioned collecting data from the preservice student teachers during their final year in the program. What time of the year did you collect data?
- Did the students receive any instruction on academic integration prior to collecting data?

There was a series of studies conducted in the mid to late 80's regarding mathematics problem solving abilities by Gliem et al and at least one dissertation not mentioned in the literature review by Hunnicutt that would have been beneficial to this study. This also leads me to a few more questions such as:

- Why did the researchers develop their own instrument when others existed?
- Are there any studies out there that look at the agricultural education teachers' attempts to integrate math into specific classes or as a whole curriculum?

The methodology appeared to be solid, but did leave some questions unanswered; such as:

- Were the participants allowed to use calculators?
- Did you administer the efficacy test prior to or after the ability test?
- Do you think you would find a difference based on the order that you submitted the instruments?

After reading through the data analysis section and the results section a few questions emerged from those areas as well.

- Was there any specific content area in math that they did better or worse in?
- With a snap-shot picture of the current group of student teachers being deficient in mathematics should that result in the proposed changes or should additional data collection take place before changing admission requirements and program of study changes?
- How do the current findings compare to those from the 80's are we doing better, staying the same or getting worse?

Session F: Agricultural Education: Enhanced Learning Am Bank Room 226

Determining the Effect of a Science-Enhanced Curriculum on Agricultural Content

Knowledge: A Causal Comparative Study

Practical Implications for the Experiential Learning Theory in Agricultural Education: A

Conversation with Dr. David A. Kolb

Effects of Inquiry-based Agriscience Instruction on Student Argumentation Skills

Does Cognitive Diversity in Groups Really Enhance Application?

Tuesday, February 8

8:30 – 9:30 a.m. Concurrent Research Session III

Session G Agricultural Education: A broader view..... Bayfront Corpus Christi Ballroom B

A Critique
A Gender analysis of Job Satisfaction Levels of Agricultural Education Teachers in Georgia
Jacquelyn Deeds, Professor
Mississippi State University

The researchers chose to research a topic that has received much attention in our profession that of burnout and job satisfaction. It is a topic of importance because of the need to keep well qualified individuals in the field where we have a shortage of teachers to fill programs. It is also significant as we look at the profession wide goal 10,000 agriculture programs by 2015. That goal requires that we maintain and improve the programs we have and increase the number of teachers to open new programs.

Questions derived from reading the paper:

Why did the authors chose to focus on gender when in the extensive literature review only one study of the numerous cited indicated that gender might make a difference? Most studies cited indicated no differences were found.

An explanation is needed as to why, when using a convince sample of those attending a conference you can justify calling those who attended a January meeting early responders and those who attend a meeting in July late responders. Non-response to this reader should have been those not attending either meeting.

Further clarification is needed regarding the implication that "individuals that identify areas of discontent should work with ...supervisors and area teachers to set goals annually for their respective programs of work." The findings indicated there were no areas of dissatisfaction and no individual data were reported. How would these individuals be identified?

While I personally agree with the recommendation that females be recruited to enter the teaching profession to close the gender gap, where were the findings that support the recommendation?

Finally the recommendation for further study to survey teachers that have left the profession as to their level of job satisfaction is a good one and has been made many times before even in the papers cited. Why hasn't anybody done that rather than replicate other studies?

I would note as I went to the references cited to find the studies that addressed job satisfaction and gender to see if they made similar recommendations, the references were not found.

A Critique
An Examination of Trust-related Behaviors Important to Agricultural Stakeholders
Jacquelyn Deeds, Professor
Mississippi State University

The authors of this study are to be commended for taking on research related to a specific project and trying to improve the process. The idea of communities of practice is not as familiar to research in agricultural education and one that deserves more attention to further important content areas.

The idea of using a popular press publication by Covey that is well recognized and well accepted is novel and is something bears further consideration.

The authors used Principal Component Analysis which is a very statistically intense process. Additional discussion in the theoretical framework about PCA would have been beneficial to the reader.

Questions generated from reading the paper:

Is there a way to make the statistical analysis required for the findings easier to follow? Almost three pages were required to describe the process which would make the research hard to understand by the respondents to the study.

Because a convenience sample was used of people at a meeting why did only half respond? Non response error was not addressed in the paper.

It was not clear why we have 11 items on Table 1 and 13 on Table 2. Some items were discarded because of too few items but some constructs only started with one and that was confusing.

What was the reason for not pilot-testing the instrument? Because the instrument was researcher developed the research findings would have been stronger all of the constructs had the high reliability that some of the other had. For example the transparency construct had a .38 Cronbach's alpha yet, Transparent and Honest was one of the final factors which raises some questions that a pilot test might have answered. The authors did discuss this in the implications.

The conclusions stayed within the findings and have some important ramifications. How do the authors suggest we make use of these findings in leadership education programs? Where would be the best place in our curriculum to present these topics to undergraduates?

A Critique
Proposed Solutions Toward Inclusive Agricultural Education Programs
Jacquelyn Deeds, Professor
Mississippi State University

The authors are to be commended for researching an area of increasing concern within the field of education in general not just agricultural education that of inclusion. This study looked at inclusions not just related to culture and ethnicity but for students with disabilities as well.

The methodology followed accepted procedures and the authors did a good job of getting responses and used the early and late responder method of covering non-response error.

Questions generated from reading the paper:

The survey implement design was unclear. The authors indicated that it was based on a previous study in North Carolina and that it was modified for use in Texas but it was not clear how it was modified or how much. Also in the methodology did not indicate the response scale used it was later found on one of the tables.

Table 1 indicates that many participants did not respond to the demographic questions. Did the researchers get any indication as to why that happened?

Inclusion of students with disabilities was a significant part of the literature review yet only one question on the instrument addressed disabilities directly. Were the respondents provided with a definition of inclusion and diversity? If so that definition would help readers better understand the mindset of the respondents.

The paper suggests more pre-service education related to diversity and inclusion. Do we know what is generally required? Most programs require as special needs type course but how many programs require courses in teaching diverse cultures and ethnic groups?

Elaboration is needed on the “speculation from the findings that Texas agricultural education programs should have a greater impact on diversity inclusion than any other school program.”

The respondents agreed that teaching materials should reflect a diverse society in agricultural education. This reader would like to see some specific suggestions as to how this might be accomplished. Most would agree that this is an issue but lack direction in the follow through.

A Critique
Multicultural Competence: A Case Study of Teachers and Their Student Perceptions
Jacquelyn Deeds, Professor
Mississippi State University

This study was interesting in that it took a different approach to diversity and inclusion in determining perceptions of agricultural teacher's multicultural competence. The authors provided a good rationale for the study indicating that the norm in agricultural classrooms is a white teacher with diverse students. They question how competent these teachers see themselves related to multicultural issues but more importantly how skilled the students they teach think they are.

The authors are commended on using a pilot test group along with a panel of experts to determine the validity and reliability of the instruments they intended to use.

Questions generated from review of the paper;

The theoretical framework was based on the Model for Developing Cultural Competence while referenced as Figure 1.1 was not found in the paper. This made the authors of "dimension 3" less clear to the reader and how the foci were selected for study.

Was the instrument administered by the researchers on-site or mailed out? The paper indicated the schools were selected based on the cost of travel for data collection and later it was indicated that data were collected using a "simple" distribution to the teachers and their students but it was not clear how this was accomplished.

The scale used on the instrument was not found in the paper but later appeared on the tables.

The student's perceptions of teacher's multicultural competence were higher than the teacher's perceived competence. A question that needs to be answered for the reader in interpreting this finding has to do with the demographics of the students. Schools selected had 30% minority membership, students surveyed were third and fourth year students what percentage of them were minority? Can non-diverse students adequately teachers multicultural skill competence?

Are there any research findings that indicate that increased multicultural skills will increase diversity in enrollment?

The inclusion of multicultural education is again a good one but because of the lack of diversity in university faculty more direction is needed. The suggestions related to increased community involvement is most likely valid but most teachers would ask "When would you like me to do that and what should I give up that I am doing to make that happen?"

**Examining Adult Participation in a Statewide Nonformal Horticultural Program
Discussant Remarks- Donna L. Graham, University of Arkansas**

With a Master Gardener program in all 50 states of the United States and several provinces in Canada, it would be appropriate to know why adults are interested in enrolling in this non formal program. The authors set about to determine the reliability of the Mergener's Education Participation Scale (M-EPS) and whether the M-EPS was an appropriate instrument to use to measure adult motivation in a Master Gardener program.

Congratulations to the author(s) for a well written paper where the methodology was clearly explained. Efforts were taken to increase the response rate and to have representative sample of responses from the Master Gardeners in the state. Although brief, justification for the analysis was provided. The findings were well presented which made the conclusions and recommendations easy to follow and clear. More discussion was needed on the factor reliability levels and clarification on whether there are 43 or 41 items on the M-EPS scale? Are the items in table 2 the new factors that loaded on the original (and now renamed) factors? Information was presented as how these constructs compared to Houle's typology of learning classifications.

Did the master gardener's study provide a different or new insight into adult learner's motivations?

By using Principal Component Analysis as a tool in exploratory data analysis for creating predictive models, the researcher(s) have gained an understanding of the motivations of adults in the Master Gardener program and how these motivations relate to Hoyle's typology. Now what? What specific recommendations could be made to the state coordinator of the master gardener program in this state?

Refocusing Evaluation Efforts: Evaluating Extension Programs for Use Can Enhance Accountability Efforts

Discussant: Donna L. Graham

The author(s) are to be commended for investigating an important research area, yet practical question. The study sought to determine whether the perception of evaluation use is related to evaluation behaviors. With the increased pressure to be accountable to the public and legitimize budgetary support, evaluation is a very important responsibility of all extension professionals.

The purpose and objectives are clear and the paper is clearly written. The author(s) did a good job in providing the theoretical framework to provide the reader with the necessary understanding of the study. The instrument, as developed by the researcher(s), was explained as was the reliability of the constructs. However, I would have liked additional explanation regarding the instrument development. Did the panel of experts create the list of 27 questions based upon their practice of evaluation? Was there a variety of extension professionals who contributed responses of the methods used or did the panel assume they were familiar with all possible methods in use? Why was there only one question relating to process use? Were the categories of use categorized by the researchers?

The respondents to the census study provided good representation of all gender, ethnicity, educational level, and program area of the population. If surveys with missing or incomplete data were eliminated, some discrepancy in the response rate, useable rate, and numbers in table 1 exist.

The results explain why agents in this state do just enough to satisfy evaluation requirements and validate the long held assumptions of the perceived use of evaluation efforts. The recommendations can be used to guide extension administration in changing the culture of evaluation behaviors and increasing the competency of the agents involved. The author(s) are to be commended for this study.

A Quantitative Analysis of the Efficacy of a Cross-Cultural Immersion Program for Extension Educators

Discussant Remarks- Donna L Graham

With the rapid growth of the Hispanic populations, Cooperative Extension has faced challenges adapting its programming efforts for this population due to the lack of cultural understanding and language barriers. I applaud the Georgia Extension Service for recognizing this need and obtaining funding to help its agents develop cultural competence.

The paper presents the quantitative results of a study to determine the efficacy of the cross-cultural immersion program. However, clarity is needed in the text to clearly state if the study had objectives based on the operation objectives, primary objectives, program objectives or guiding questions? Questions 4 and 6 of the guiding questions seem to be asking for the same information.

The methodology was clearly explained, however, the response rate is puzzling. What is the logic of eliminating the retirees from the study? With only 15 non-respondents, why were they not contacted? Was there a program in 2003?

The findings are very vague without an understanding of the questions that composed the constructs that guided the study. More information is needed to explain how the constructs were developed and tested for reliability. The findings are brief and offer little information without the qualitative data. Only the question responses are listed under question 6.

I commend the author(s) for studying whether a cross cultural immersion program is having an impact on serving the Hispanic population in Georgia. The findings may have generalizations for other agents or states considering such a program4-H

4-H Volunteers Intent to Support Youth with Disabilities: An Elicitation Study

Discussant: Donna L Graham

The authors are to be commended for conducting formative research to establish the beliefs and behaviors of 4-H volunteer leaders toward working with children with disabilities.

The purpose and theoretical framework was clear and provided the reader with the background necessary to understand the concepts used in the study. The paper was well written but editing would add clarity in the methodology section. The instrument coding of the responses was explained prior to a description of the subjects and procedures of collecting the data. Some of the methodology is explained in the results section.

Convenience sampling is not the optimal method for soliciting response but the researcher (s) justified its use for this study and noted caution on this sampling technique in the conclusions. The findings were very interesting and will provide valuable data to develop an instrument for additional study. However, I wondered if 4-H leaders who have served from 12-30 years provided a biased response set? Since school clubs have trained personnel on location, would the responses from community based club leaders be different? More explanation of how items that are enabling beliefs work in conjunction with inhibiting beliefs to influence behavior would be helpful?

Intervention is mentioned multiple times in the conclusions section. Is the long range goal to influence inclusionary support of youth with IDD in 4-H? While very valuable information was obtained in this elicitation study, the researcher(s) recognize additional study is needed regarding the behavioral, normative and control beliefs of 4-H leaders.

Session I Agricultural Education: Laboratories
and Mechanization Bayfront Corpus Christi Ballroom C

**Economic Impact of Agricultural Mechanics Competition Projects in (State) and Factors
that Predict Chapter Investment Value: State Returns from 2009 - 2010**

Discussant Remarks - Kirk C. Edney, Ph.D. Texas A&M University

Agricultural science has long recognized the link between experiential learning through an SAE and student achievement. Students engaging in many types of SAEs incur an additional cost, seldom funded by the educational system. In this time of scarce resources and increased awareness of the importance of return on investment, identifying the extent and positive local impact of student participation is extremely important.

The authors used experiential learning theory to guide their study, and examined previous research in the value of SAE focused on a contemporary conceptual model of laboratory instruction for organization.

The study utilized a descriptive survey design, and coupled the responses with IMPLAN software to generate economic impact values.

The implication of increased emphasis on inclusion of power, structural and technical systems SAEs is very timely. A greater effort should be made to incorporate career cluster terminology where appropriate.

Questions for discussion include:

An enrollment of 77,000 students in 491 programs seems out of proportion with the total state enrollment. Does this approximate half of the state enrollment?

The finding that agricultural mechanics project shows are not always considered “normal” SAEs gives pause to reconsider how we tend to define SAE participation.

Further studies might investigate the impact of including capital expenditures associated with SAE development, the average number of hours expended per project, and the financial impact of prize premiums.

Student Perceptions of Instructional Methods Towards Alternative Energy Education

Discussant Remarks - Kirk C. Edney, Ph.D. Texas A&M University

Teacher education is concerned with providing effective teacher preparation and encouraging the continual development of instructional techniques by practicing teachers. The emerging field of alternative energy education serves to identify an area where professional development is needed. However, traditional lecture may not be the best delivery method for alternative energy instruction.

The authors used experiential learning theory to guide their study, and forwarded the concept of 'tinkering self-efficacy' as a method of increasing student interest and engagement in subject matter.

The study utilized a pre-experimental design number two as defined by Campbell and Stanley; a modified One-Group Pretest-Posttest Design, and was part of a larger project.

The process outlined for securing permission to participate from the parents of secondary students ensured that IRB constraints were observed.

This study was very thorough; the data reported addressed aspects from instrument reliability to survey findings, and generated a significant amount of knowledge with a wide range of applicability for classroom instructional practice.

A greater effort should be made to incorporate career cluster terminology where appropriate.

Questions for discussion include:

What strategies can be utilized to develop or encourage tinkering self-efficacy in female students?

We often hear the term 'biodiesel.' How is biodiesel defined? Are there varieties and blends of biodiesel? What are some advantages of biodiesel in addition to reduced carbon dioxide emissions and its manufacture from renewable sources?

Teachers' Use of Agricultural Laboratories in Secondary Agricultural Education

Discussant Remarks - Kirk C. Edney, Ph.D. Texas A&M University

The agricultural science laboratory facility is the most visible part of the local program. It is critical that our profession identify both the types of facilities present and the levels and degrees of facility usage by practicing teachers.

The authors used experiential learning theory to guide their study, and focused on a contemporary conceptual model of laboratory instruction for organization.

The study utilized a non experimental descriptive survey design to determine the current status of laboratory use, and was based on previous research. The sample was well chosen.

I found the reported variance between frequency of laboratory use and negative perceptions of learning to be unusual.

The implication of focusing instructional strategies related to laboratory use on pre-service teachers to be very timely.

Questions for discussion include:

What impacts the correlation between frequency of laboratory use and participation in secondary agricultural education as a student?

Are the majority of agricultural education students located in rural schools?

Agricultural Mechanics Laboratory Safety: Professional Development Needs of Kentucky School-Based Agricultural Educators

Discussant Remarks - Kirk C. Edney, Ph.D. Texas A&M University

We find another study on agricultural mechanics laboratory safety. Are we reaching the saturation point? Hardly; safety instruction demands significant emphasis from teachers and teacher educators to yield both effective instruction and a safe learning environment. The acceptable lower limit for effective safety instruction and practice is one hundred per cent. The authors use andragogy and self-efficacy theories to guide their study.

The study utilized a non-experimental, quantitative design focused on the Borich Needs Assessment Model. One product of the study was a state-wide needs assessment to provide baseline data.

A greater effort should be made to incorporate career cluster terminology where appropriate.

Questions for discussion include:

Can a study variable be designed that incorporates student crowding as an administrative cause, rather than a teacher cause?

Can a variable be designed that assesses the amount of “unsafe-ness” attributable to budgeting issues and / or administrative decisions?

Can a variable be developed that identifies teacher certification as alternative, traditional, and/or locally-certified? This could serve to identify the safety effectiveness (and associated liability issues) to quality and efficacy of the teacher certification process.

Is there a process that can link study results to educational leadership and associated decisions?